

SPECIFICATION OF WCM-HDMI SERIES

FEATURES & APPLICATIONS

Lowprofile and very small size SMD Design,
Wound Chip constructure with standard 0805 size,
with best EMI suppression effect
but least impact to HDMI signal wave form.
Due to match with line impedance of 100 ohmline.

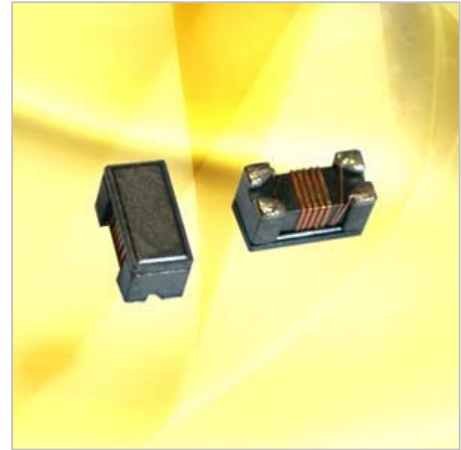

ORDERING CODE

WCM - 2012 HDMI - 900 T
(1) (2) (3) (4) (5)

- (1) PRODUCT TYPE CODE
- (2) PRODUCT SIZE CODE
- (3) DESIGN CODE
- (4) IMPEDANCE
- (5) TAPING

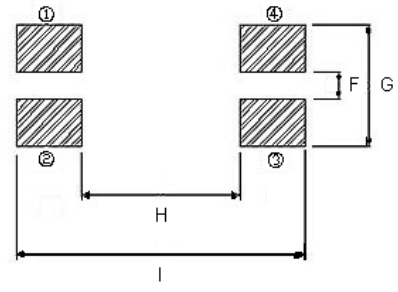
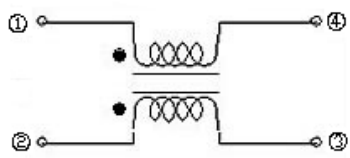
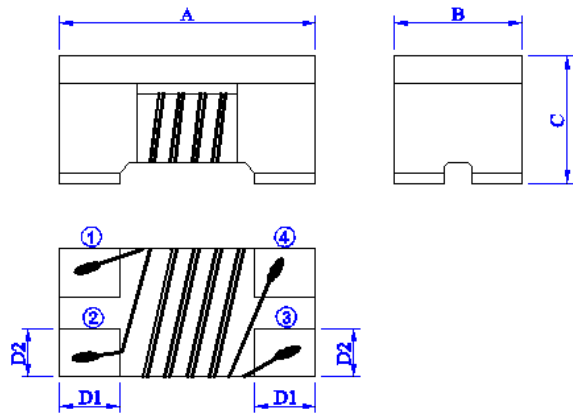

APPEARANCE & DIMENSIONS

UNIT:mm (inch)

SIZE CODE	A	B	C	D1 TYP	D2 TYP	F TYP	G TYP	H TYP	I TYP
WCM-2012HDMI (0805)	2.00±0.20 (0.079±0.008)	1.20±0.20 (0.047±0.008)	1.20±0.20 (0.047±0.008)	0.45 (0.018)	0.40 (0.016)	0.40 (0.016)	1.20 (0.047)	0.80 (0.031)	2.60 (0.102)

※All the data listed in this catalogue are for reference only, King Core reserves the right to alter or revise the specifications without prior notification.

COMMON MODE CHOKE → WCM-2012HDMI SERIES

ELECTRICAL CHARACTERISTICS

ORDERING CODE	Impedance (Ω)	Tolerance ±%	Test Frequency (MHz)	DC Resistance (Ω)max	Rated Current (mA)max
WCM-2012HDMI-400T	40	25%	100	0.25	400
WCM-2012HDMI-670T	67	25%	100	0.25	400
WCM-2012HDMI-900T	90	25%	100	0.30	400
WCM-2012HDMI-121T	120	25%	100	0.30	370

WCM-2012HDMI-400T

1. Electrical Characteristic Curve
2. TDR Impedance Curve (For HDMI)
3. Insertion Loss Curve (For HDMI)

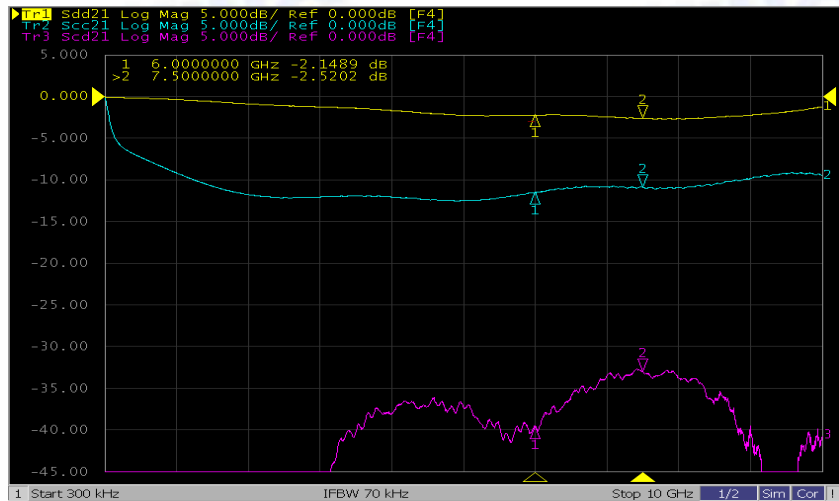
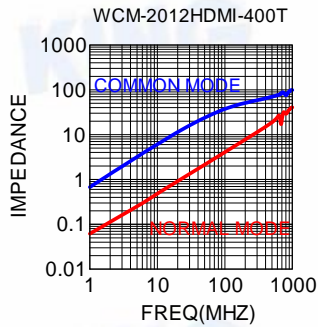

WCM-2012HDMI-670T

1. Electrical Characteristic Curve
2. TDR Impedance Curve (For HDMI)
3. Insertion Loss Curve (For HDMI)

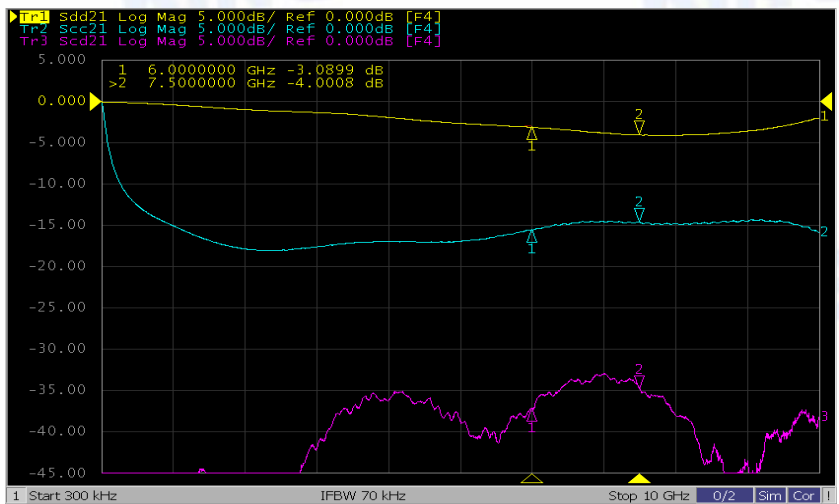
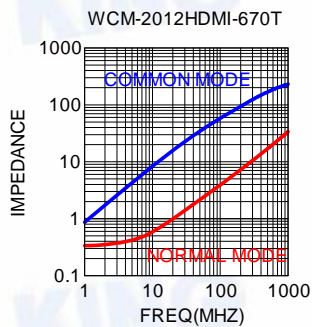

***Design as Customer's Requested Specifications.**

※All the data listed in this catalogue are for reference only, King Core reserves the right to alter or revise the specifications without prior notification.

COMMON MODE CHOKE → WCM-2012HDMI SERIES

WCM-2012HDMI-900T

1. Electrical Characteristic Curve

2. TDR Impedance Curve (For HDMI)

3. Insertion Loss Curve (For HDMI)

WCM-2012HDMI-900T

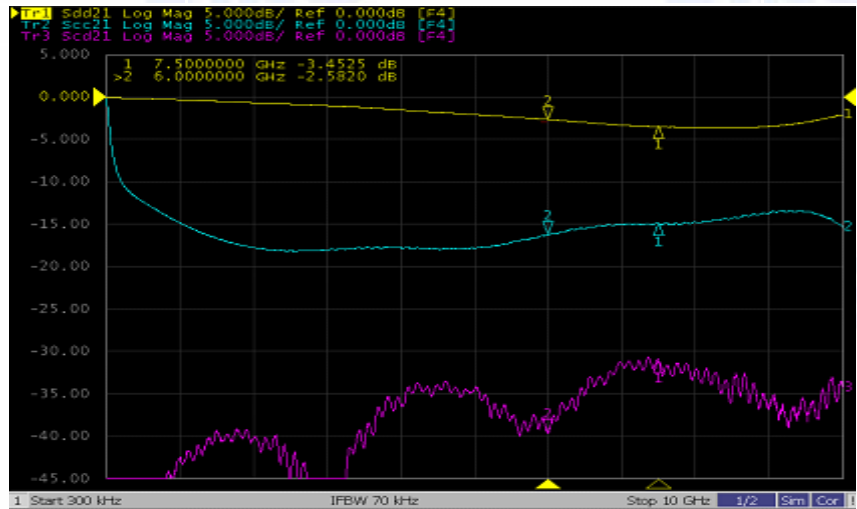
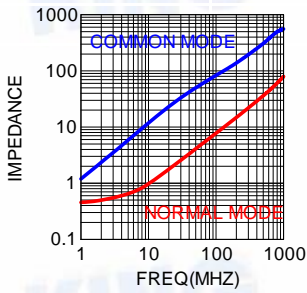

WCM-2012HDMI-121T

1. Electrical Characteristic Curve

2. TDR Impedance Curve (For HDMI)

3. Insertion Loss Curve (For HDMI)

WCM-2012HDMI-121T

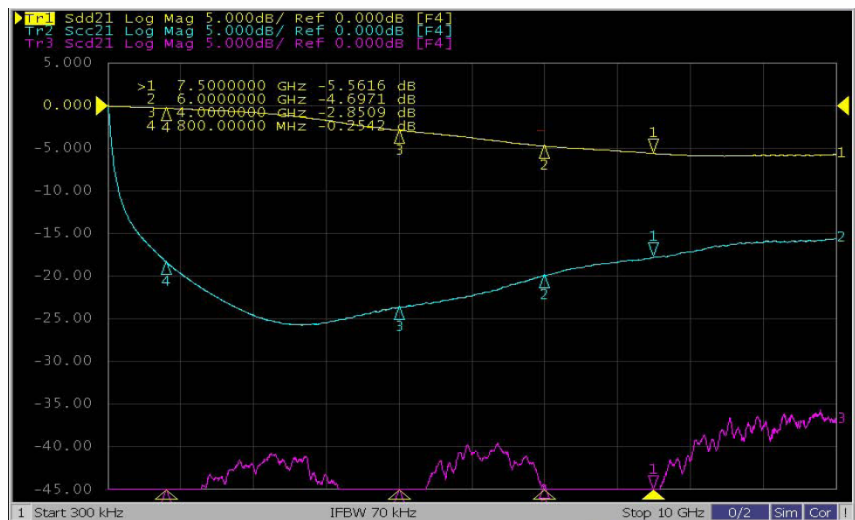
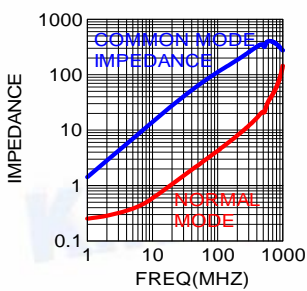

***Design as Customer's Requested Specifications.**

※All the data listed in this catalogue are for reference only, King Core reserves the right to alter or revise the specifications without prior notification.



KING CORE ELECTRONICS INC.
Tel:886-3-4698855 Fax:886-3-4691395

No.269,Nanfong Rd.,Pingjhen City,Taoyuan County, Taiwan
E-mail:kc@mail.kingcore.com.tw Web Site:http://www.kingcore.com.tw