

Mini Relay K (Open – Sealed)

- Limiting continuous current 20A
- 24VDC coil versions available

Typical applications

Car alarm, hazard warning signal, heated rear screen, immobilizer, lamps front/rear, fog light, interior lights, sun roof, turn signal, wiper control.

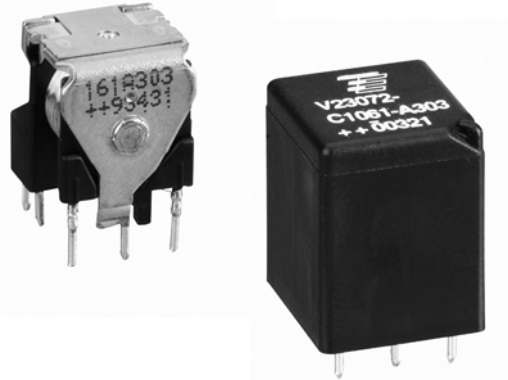

F072A/C_fw2b

Contact Data

Load	resistive/inductive load V23072-C10**-A302	resistive/inductive load V23072-C10**-A303	resistive/inductive load V23072-C10**-A308	head/indicator lamp V23072-C1061-A402	head/indicator lamp V23072-C1061 A408
Contact arrangement	1 form A, 1 NO	1 form C, 1 CO	1 form U/X, 2 NO	1 form A, 1 NO	1 form U/X, 2 NO
Rated voltage	12VDC	12VDC	12VDC	12VDC	12VDC
Rated current	15A	10/15A	2x10A	12A	2x6A
Limiting continuous current					
23°C	15A	10/15A	2x10A	12A	2x6A
85°C	10A	5/10A	2x6A	10A	2x5A
Limiting making current ¹⁾²⁾	60A	NC/NO 12/60A	2x40A	60A ³⁾	120A ³⁾
Limiting breaking current	20A	10/20A	2x20A	6A	12A
Contact material	AgNi0.15	AgNi0.15	AgNi0.15	AgSnO.2	AgSnO.2
Min. recommended contact load ⁴⁾	1A at 5VDC	1A at 5VDC	1A at 5VDC	1A at 5VDC	1A at 5VDC
Initial voltage drop at 10A, typ./max. 150/300mV		50/300mV	50/300mV	2x50/300mV	150/300mV
Operate/release time max.			typ. 3/1.5ms ⁵⁾		
Electrical endurance	>2x10 ⁵ ops. at 13.5VDC, 10A	>2x10 ⁵ ops. at 13.5VDC, 10A	>2x10 ⁵ ops. at 13.5VDC, 10A	>1x10 ⁶ ops. up to 6x21W >1.5x10 ⁵ ops. 100A (on), 10 A (off) high beam	>1.5 x 10 ⁶ ops. up to 6x21W >7.5x10 ⁵ ops. 100A (on), 10A (off) high beam

1) The values apply to a resistive load or inductive load with suitable spark suppression and at maximum 13.5VDC for 12VDC and 27VDC for 24VDC load voltages.

2) For a load current duration of maximum 3s for a make/break ratio of 1:10.

3) Corresponds to the peak inrush current on initial actuation (cold filament).

4) See chapter Diagnostics of Relays in our Application Notes or consult the internet at <http://relays.te.com/appnotes>

5) For unsuppressed relay coil. A low resistive suppression device in parallel to the relay coil increases the release time and reduces the lifetime caused by increased erosion and/or higher risk of contact tack welding (monostable version only).

Max. DC load breaking capacity

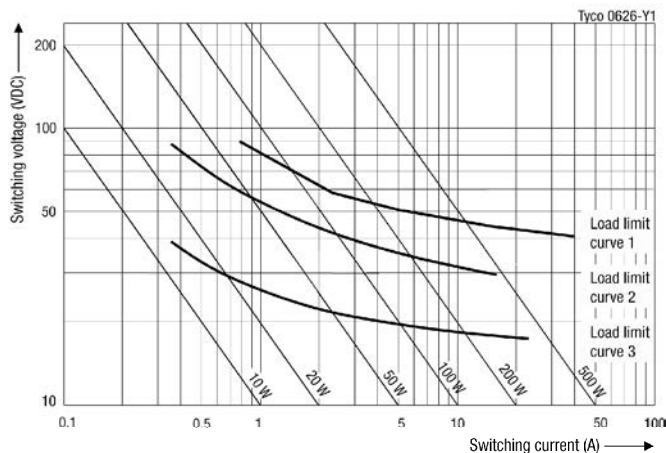

Load limit curve 1: safe shutdown, connected as form X, load on pin 5 and 7.
 Load limit curve 2: safe shutdown, no stationary arc (NO contact).
 Load limit curve 3: arc extinguishes during transit time (CO contact).
 Load limit curves measured with low inductive resistors verified for 1000 switching events.

Mini Relay K (Open – Sealed) (Continued)

Coil Data

Rated coil voltage	12VDC, 24VDC
--------------------	--------------

Coil versions, DC coil

Coil code	Rated voltage VDC	Operate voltage VDC	Release voltage VDC	Coil resistance $\Omega \pm 10\%$	Rated coil power W
061	12	6.9	1.2	130	1.1
062	24	14.1	2.4	520	1.1

All figures are given for coil without pre-energization, at ambient temperature +23°C.

Coil operating range

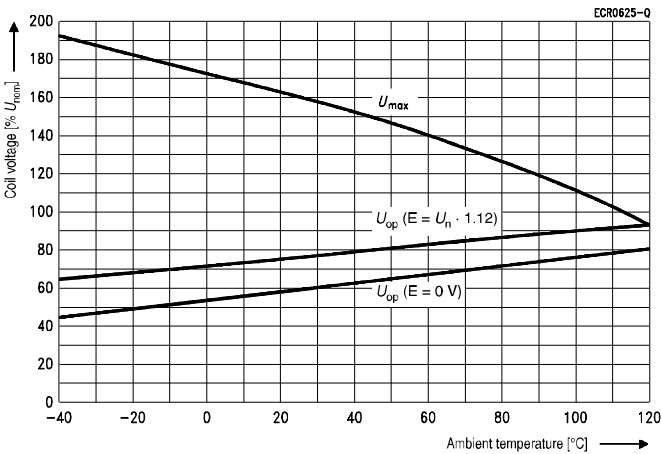

Does not take into account the temperature rise due to the contact current
E = pre-energization.

Terminal Assignment (Open and Sealed version)

Bottom view on solder pins

1 form A, NO

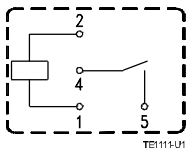

1 form U/X, 2 NO

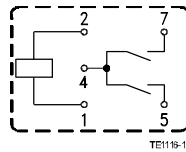

1 form C, CO

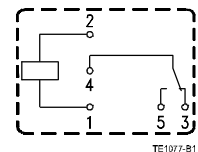

Other Data

EU RoHS/ELV compliance	compliant
Degree of protection IEC 61810	RT II – open (V23072-A), RT III – imm. cleanable (V23072-C)
Climatic cycling with condensation EN ISO 6988	20 cycles, storage 8/16h
Temperature cycling (shock) IEC 60068-2-14, Na	720 cycles, -40/+85°C (dwell time 1h)
Damp heat constant IEC 60068-2-3, Ca	56 days, upper air temperature 55°C
Corrosive gas IEC 60068-2-42	10 days
IEC 60068-2-43	10 days
Vibration resistance (functional) IEC 60068-2-6 (sine sweep), 10 to 200Hz,	23 to 35g ⁶⁾
Shock resistance (functional) IEC 60068-2-27 (half sine), 4 to 6ms	23 to 280g ⁶⁾
Terminal type	PCB
Weight, open/sealed	approx. 8/9g (0.28/0.32oz)
Solderability (aging 3: 4h/155°C) IEC 60068-2-20	Ta, method 1, hot dip 5s, 215°C
Sealing, IEC 60068-2-17	Qc, method 2, 1min/70°C
Storage conditions	according IEC 60068 ⁷⁾
Packaging unit open	600 pcs.
sealed	504 pcs.

6) Values weakest direction. Depending on mounting position: no change in the switching state >10µs.

7) For general storage and processing recommendations please refer to our Application Notes and especially to Storage in the Definitions or at <http://relays.te.com/appnotes/>

Mini Relay K (Open – Sealed) (Continued)

Dimensions

Mini Relay K Open Version

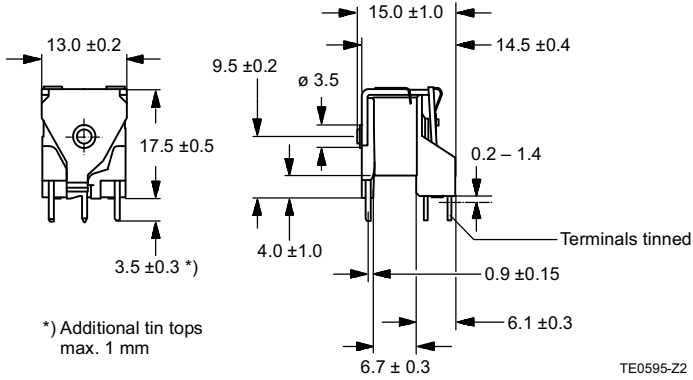

Mini Relay K Sealed Version

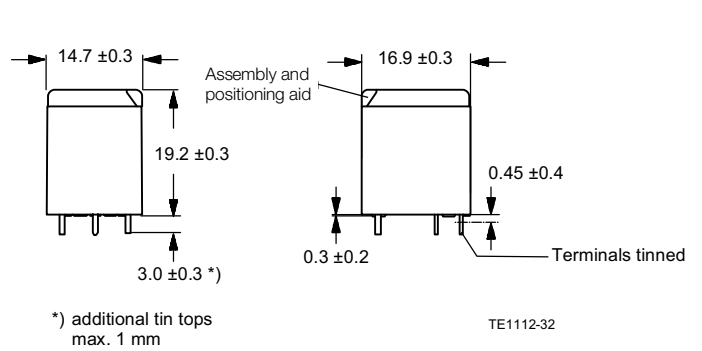

View of the terminals (bottom view)

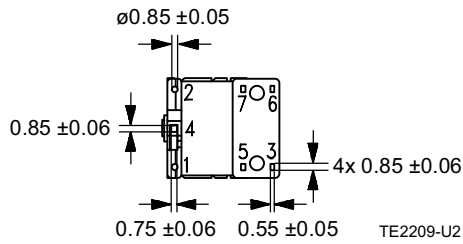

View of the terminals (bottom view)

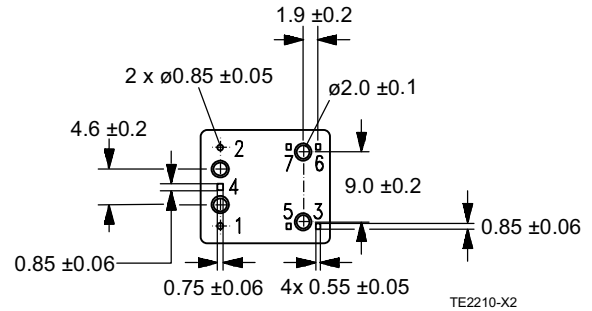

PCB Layout

Bottom view on solder pins, grid 1.25 to 1.27mm

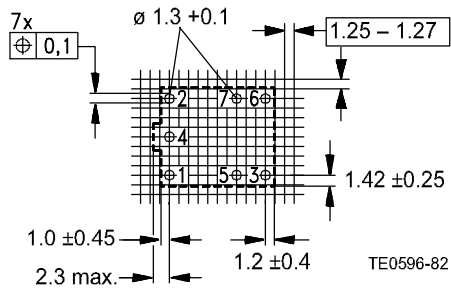

PCB Layout

Bottom view on solder pins, grid 1.25 to 1.27mm

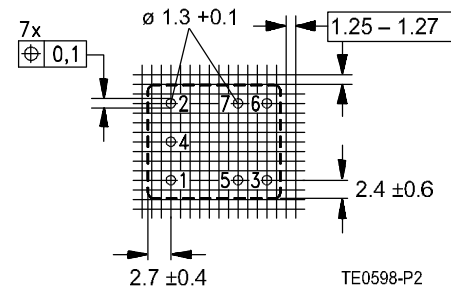

Mini Relay K (Open – Sealed) (Continued)

Product code structure		Typical product code		V23072	-A	1	061	-A	30	2
Type		V23072 Mini Relay K (Open – Sealed)								
Terminal and enclosure		A PCB, open (RT II)		C PCB, sealed (RT III – immersion cleanable)						
Design		1 Standard								
Coil		061 12 VDC		062 24 VDC						
Contact type		A Standard								
Contact material		30 AgNi0.15		40 AgSnO ₂						
Contact arrangement		2 1 form A, NO		3 1 form C, CO		8 1 form U/X, 2 NO				

Product code	Terminal/Encl.	Design	Coil	Contact type	Cont. material	Arrangement	Part number
V23072-A1061-A303	PCB, open	Single relay	12VDC	Standard	AgNi0.15	1 form C, CO	3-1393272-2
V23072-A1062-A303			24VDC			5-1393272-2	
V23072-A1061-A308	PCB, sealed		12VDC			1 form U/X, 2 NO	3-1393272-6
V23072-A1062-A308			24VDC			5-1393272-3	
V23072-C1061-A302			12VDC			4-1393273-9	
V23072-C1062-A302			24VDC			7-1393273-6	
V23072-C1061-A303			12VDC			5-1393273-6	
V23072-C1062-A303			24VDC			7-1393273-8	
V23072-C1061-A308			12VDC			1 form U/X, 2 NO	6-1393273-0
V23072-C1062-A308			24VDC			8-1393273-2	
V23072-C1061-A402			12VDC			2-1416001-0	
V23072-C1061-A408			AgSnO ₂			1 form A, NO ⁸⁾	2-1416001-0
						1 form U/X, 2 NO ⁸⁾	1-1416001-4

8) Flasher/Lamp