

# MOS INTEGRATED CIRCUIT

# $\mu$ PD1703C-015

## PLL FREQUENCY SYNTHESIZER AND CONTROLLER FOR FM/MW/LW TUNER

The  $\mu$ PD1703C-015 is a single chip CMOS LSI designed for a Phase Locked Loop (PLL) Frequency synthesizer digital tuning system controller of FM/MW/LW European band.

The  $\mu$ PD1703C-015 provides a high performance varactor-tuned FM/MW/LW tuner accompanied with the prescaler  $\mu$ PB553AC.

The  $\mu$ PD1703C-015 is packed in a 28-pin slim dual in line package (DIP).

### FEATURES

- Fluorescent Indicator Panel (FIP) segments direct drive output
- Incorporated PLL frequency synthesizer, swallow-counter, and controller
- Easy back-up preset memories (less than 10  $\mu$ A)
- Display a preset station by LED lamp
- High FM reference frequency 25 kHz (By employing pulse swallowing method)
- Alterable frequency bands: either FM/MW/LW or FM/MW by initial set switch
- 14 preset station memories by 7 preset memories switches; (FM/MW; 7 stations/7 stations, or FM/MW/LW; 7 stations/4 stations/3 stations)
- Accepts to use either 'momentary switch' or 'alternate switch' for preset key and 'frequency band selecting key'
- One last station memory each for FM/MW/LW capability
- Up/Down searching by both way; AUTO and MANUAL
- IF OFF-set capability (10.650, 10.675, 10.700, and 10.725 MHz)
- Two way display; multiplier or static selectable by initial-set switch.
- Channel number display capability (-2 CH through 70 CH, FM band only)
- 'EXTERNAL DATA PRESET' function, usefull for tracking-point adjustment on massproduction
- 4 1/2-digit display for tuned frequency
- 28-pin slim dual in-line package (DIP)
- Single power supply; 5 V  $\pm$ 10 %

## FUNCTION

Receiving frequency, channel spacing, reference frequency, intermediate frequency

BAND	FREQUENCY RANGE	CHANNEL SPACING	REFERENCE FREQUENCY	INTERMEDIATE FREQUENCY
FM	87.50 to 108.00 MHz	50 kHz	25 kHz	10.650, 10.675, 10.700, 10.725 MHz
MW	522 to 1 611 kHz	9 kHz	9 kHz	450 kHz
LW	155 to 353 kHz	9 kHz	1 kHz	450 kHz

### Station selection modes;

(1) AUTO UP/DOWN TUNING ('triangle wave form' tuning)

During the SD, station detector, terminal receives high level input signal, searching operation stops and continues to receive the detected station. If the top or bottom of the band is reached, the searching operation will reverse direction – from upwards to downwards, or reversely.

(2) MANUAL UP/DOWN TUNING ('triangle wave form' tuning)

The 'Down' (tune down) and the 'UP' (tune up) keys are dual function keys.

A) A single momentary depression will tune to next station.

B) Continuous depression over 0.5 seconds allows traversing down or up the entire band until these keys are released.

If the top or bottom of the band is reached, the Manual searching operation will stop.

(3) RECALL PRESET MEMORY

A) When 'WITH LW' key is released, seven preset stations (M1 to M7) can be recalled from the memory for each FM and MW band.

B) When 'WITH LW' key is depressed, seven preset stations (M1 to M7) can be recalled from the memory of FM band, four stations (M1 to M4) from MW band, and three stations (M5 to M7) from LW band.

### PIN CONFIGURATION (Top View)

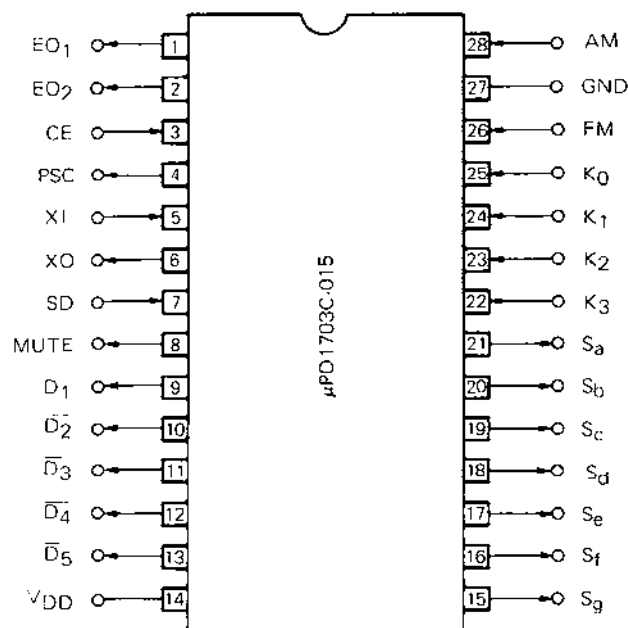

## PIN DESCRIPTION

PIN NO.	PIN SYMBOL	PIN NAME	DESCRIPTION
1 2	EO <sub>1</sub> EO <sub>2</sub>	Error out	<p>These pins provide charge-pump output from phase-detector of PLL.</p> <p>When the divided oscillation frequency is higher than reference frequency, these pins output high level, when lower, output low level. When these two frequency are same, outputs float.</p> <p>These pins accept to be connected with any LPF, Low pass filter, of MW, LW, or FM, because outputs of EO<sub>1</sub> and EO<sub>2</sub> are coincident.</p>
3	CE	Chip enable	<p>This pin is a input terminal of selection of this device operation. The high level input allows device operation.</p> <p>When low level is input, display is extinguished the operation of PLL is stopped, the internal clock generation is also stopped, but the contents of memories are held.</p> <p>The stored preset stations information is held by low level of this pin with low consumption current less than 10 <math>\mu</math>A.</p> <p>When high level is applied to this pin, it is required to make high after V<sub>DD</sub> rises over 4.5 V. When low level is applied, it is required to make low before V<sub>DD</sub> comes down to 4.5 V.</p> <p>The less than 134 <math>\mu</math>s of high or low level applying speed never accepted.</p>
4	PSC	Prescaler control	<p>This output provides a signal for selecting the divide of prescaler when the frequency is divided down by 'Pulse swallowing method. This output can be directly connected to 'PSC' pin of the prescaler <math>\mu</math>PB553AC.</p> <p>The dividers of <math>\mu</math>PB553AC are 16 and 17.</p>
5 6	X1 XO	X'tal	<p>These inputs are for connection to a 4.5 MHz crystal.</p>
7	SD	Station detector	<p>This input is used to control the station searching operation. It is high to indicate the presence of a station.</p> <p>The high level received within 75 ms after PLL is locked brings to stop of automatic searching operation.</p>
8	MUTE	Mute output	<p>This output line goes high to mute the shock noise in the case of PLL lock. If the CE terminal becomes low level, this pin goes low automatically. The mute durations in each mode are as follows:</p> <ul style="list-style-type: none"> <li>○ Band change .....800 ms approx.</li> <li>○ Manual searching .....200 ms approx. each tune</li> <li>○ Automatic searching.....200 ms approx. after SD pin receives high level signal</li> <li>○ Recall preset memory ...450 ms approx.</li> </ul> <p>These mute durations are output time after data of PLL is changed, and in fact, joined mute leading time (before data of PLL is changed): 50 ms approx.</p> <p>(See 4.2 Mute timing charts)</p>













PIN NO.	PIN SYMBOL	PIN NAME	DESCRIPTION
9 to 13	$\overline{D}_1$ to $\overline{D}_5$	Digit outputs	These outputs are digit drivers. (Active-low) (See 2. Display)
14	VDD	Power supply	5 V $\pm$ 10 % Volt supply to the chip. If the device operation is not needed except holding the memorised station information, the decrease down 3.0 V is allowed. The rising time of VDD voltage is required to be within 500 ms, if the time takes too long, the operation of initialization may be insufficient.
15 to 21	S <sub>a</sub> to S <sub>g</sub>	Segment outputs	These outputs are segment drivers. They are also used as horizontal driver for the keyboard matrix. An output, 30 V, is high for a segment of FIP to be on. (See 1.1 Configuration of key matrix and 2. Display.)
22 to 25	K <sub>0</sub> to K <sub>3</sub>	Key return signal inputs	These are Key return signal inputs from Key matrix. (See 1.1 Configuration of Key matrix.)
26	FM	FM local oscillator signal inputs	This input is the FM band local oscillator input. The frequency is divided down by 16 or 17, using the prescaler $\mu$ PB553AC. The DC of input signal must be cut by a capacitor because the AC amplifier is provided internally.
27	GND	Ground	System grounds
28	AM	AM local oscillator signal inputs	This input is the MW, LW band local oscillator input. The DC of input signal must be cut by a capacitor because the AC amplifier is provided internally.

## CONTENTS

1. KEY MATRIX .....	6
1.1 CONFIGURATION OF KEY MATRIX .....	6
1.2 KEY MATRIX CONNECTION .....	7
1.3 DESCRIPTION OF KEY MATRIX .....	10
2. DISPLAY .....	14
2.1 MULTIPLEX DRIVE DISPLAY .....	14
2.2 STATIC DISPLAY .....	16
3. PRESET STATION DISPLAY .....	18
4. TIMING CHART .....	20
4.1 DISPLAY AND TAKING IN .....	20
4.2 MUTE TIMING CHART .....	21
5. APPLICATION OF BAND SELECTION .....	22
6. EXTERNAL DATA PRESET .....	23
7. APPLICATION CIRCUIT .....	26
8. ELECTRICAL CHARACTERISTICS .....	27
8.1 ABSOLUTE MAXIMUM RATINGS .....	27
8.2 RECOMMENDED OPERATING CONDITIONS .....	27
8.3 DC CHARACTERISTICS .....	28
8.4 AC CHARACTERISTICS .....	28
9. PACKAGE DIMENSION .....	29

# 1. KEY MATRIX

## 1.1 CONFIGURATION OF KEY MATRIX

Input Output	K <sub>3</sub> (25)	K <sub>1</sub> (24)	K <sub>2</sub> (23)	K <sub>3</sub> (22)
S <sub>a</sub> (21)	DOWN	UP	MEMORY	EXT. DATA PRESET
S <sub>b</sub> (20)	 M4	 M3	 M2	 M1
S <sub>c</sub> (19)		 M7	 M6	 M5
S <sub>d</sub> (18)		 LW	 FM	 WN
S <sub>e</sub> (17)				
S <sub>f</sub> (16)	<b>WITH LW</b>	<b>STATIC/DYNA</b>	 AUTO/MANUAL	 CH/FREQ
S <sub>g</sub> (15)			<b>IF1</b>	<b>IF0</b>

Numbers in parentheses are pin No.

 : Momentary switch

 : Momentary or alternate switch

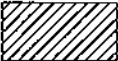
 : Alternate switch

 : Diode matrix

## 1.2 KEY MATRIX CONNECTION

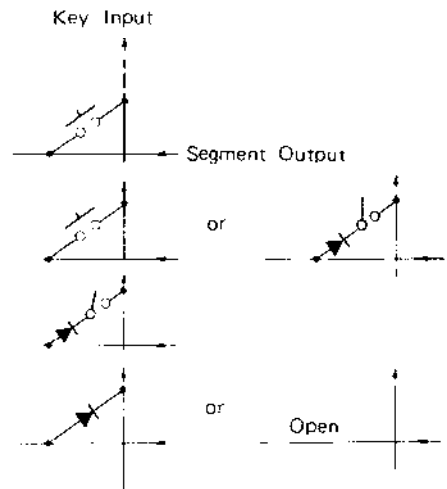
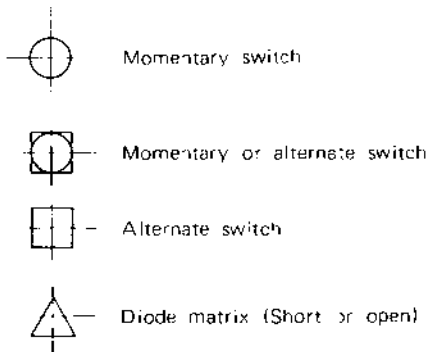
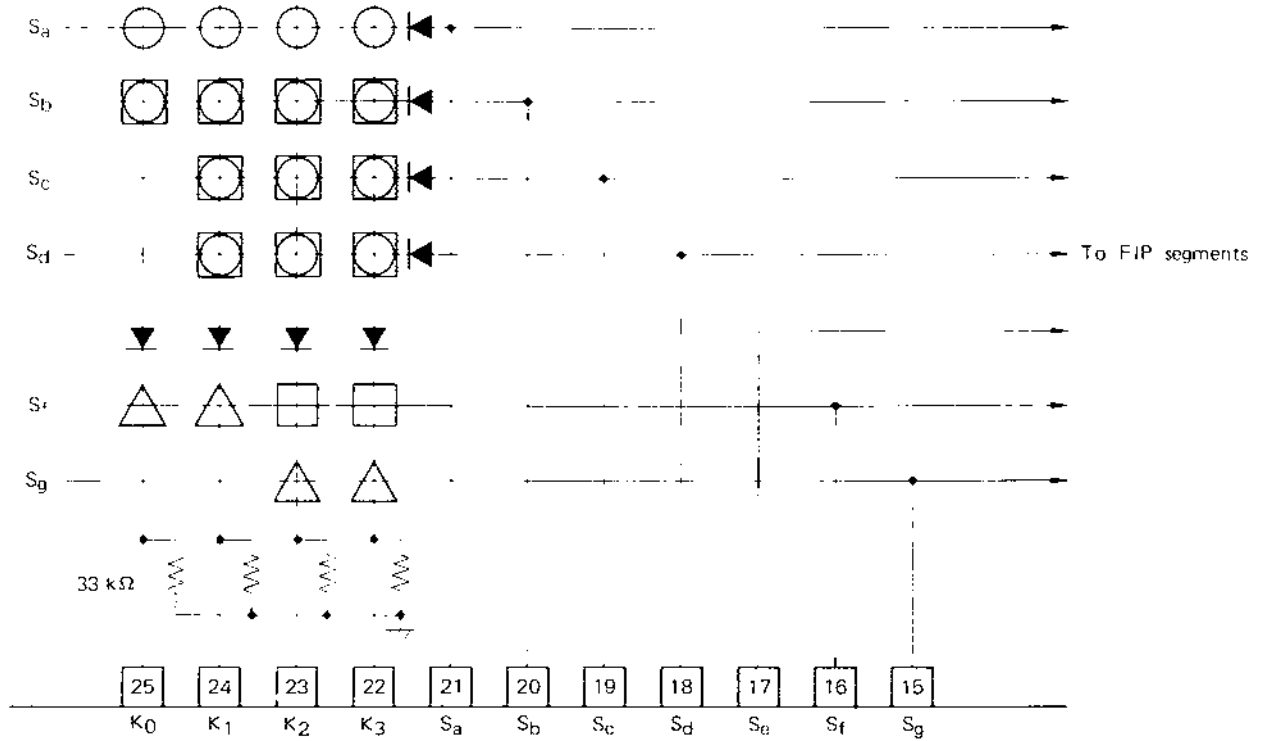

Although the PRESET KEY (  $M_1$  to  $M_7$  ) and BAND-SWITCH KEY (  $FM$ ,  $MW$ ,  $LW$  ) allow to use momentary or alternate type switch, the diodes for preventing the leak-in of key return signal should be connected as follows according to the switch type adopted.

Example-1. Momentary switches are used for PRESET and BAND SWITCH KEY

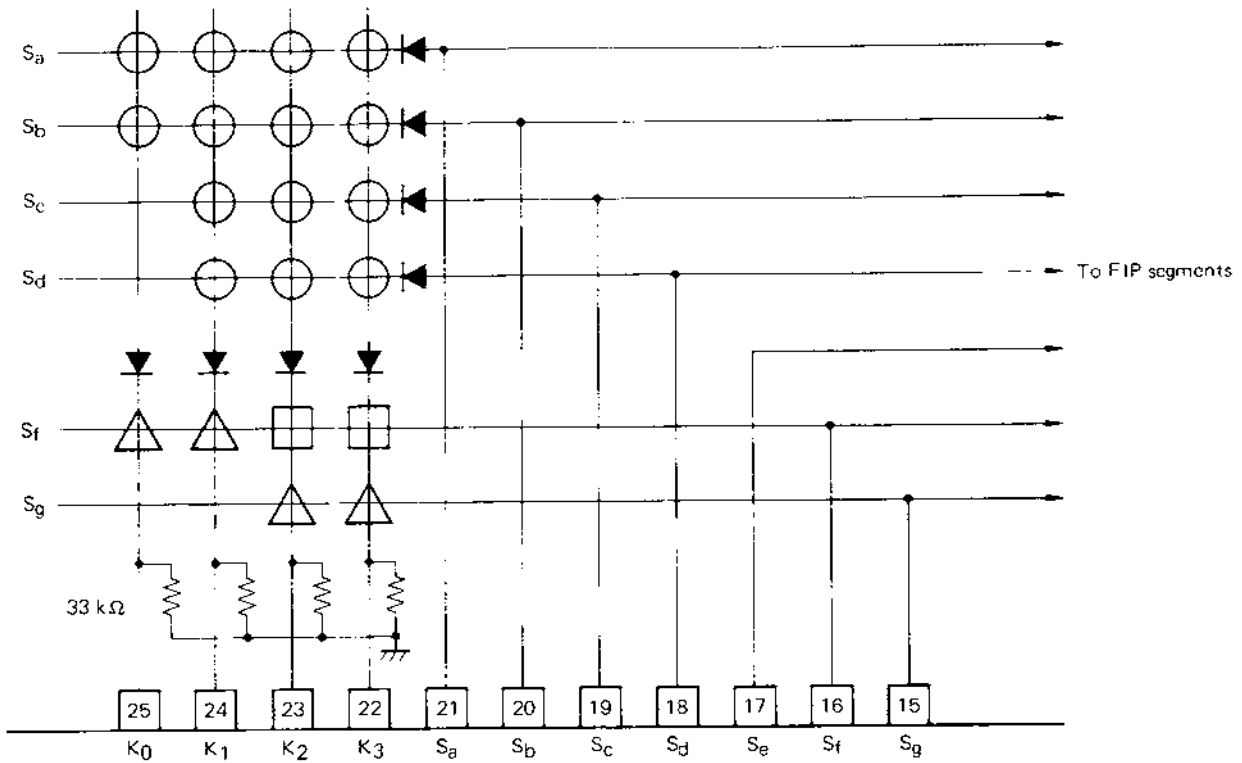

Example-2. Momentary switch is used for PRESET KEY, alternate switch for BAND SWITCH KEY

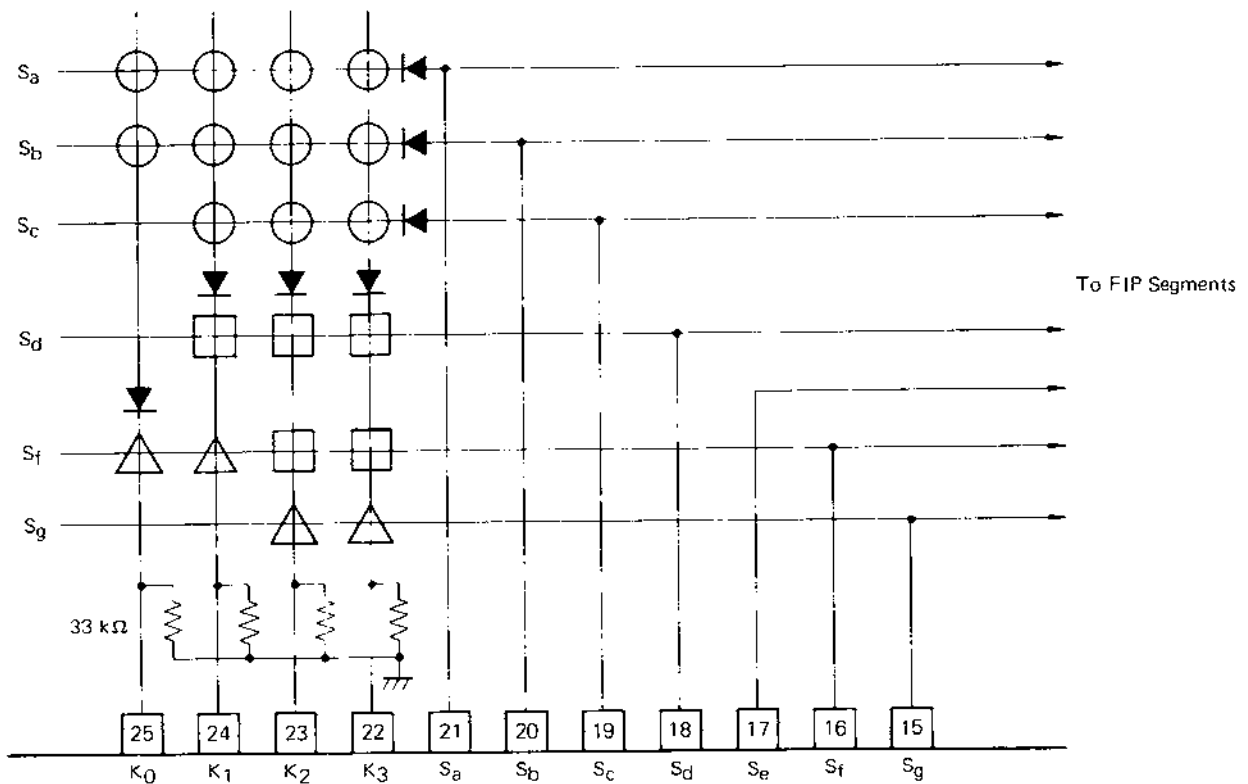

Example-3. Alternate switches are used for PRESET and BAND SWITCH KEY

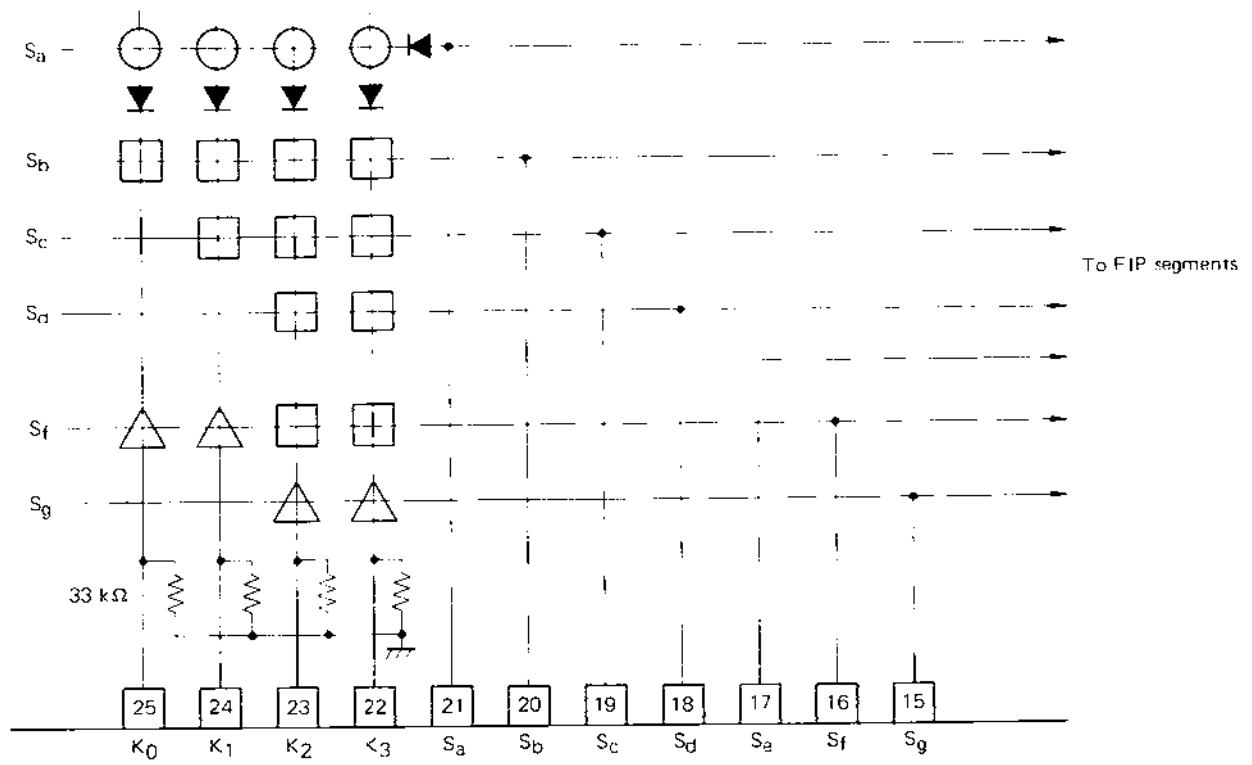

### 1.3 DESCRIPTION OF KEY MATRIX

#### INITIAL SETTING DIODE MATRIX

There are three kinds of diode matrix for initial setting.

These conditions are read into controller IC when the power initially applied to VDD terminal or when the level of CE terminal is changed from low to high.

(1) The switch for setting IF OFF-set frequency of FM.

IF1, IF0

(2) The switch for receiving LW band.

WITH LW

(3) The switch for selecting static or dynamic drive display.

STATIC/DYNA

These setting are to put diode across the points matrix intersection, or open (The meaning of "1" is short and "0" is open in the following description.)

SYMBOL	DESCRIPTION															
IF1 IF0	<p>The four intermediate frequencies can be selected.</p> <table border="1"> <thead> <tr> <th>IF1</th> <th>IF0</th> <th>IF</th> </tr> </thead> <tbody> <tr> <td>0</td> <td>0</td> <td>10.700 MHz</td> </tr> <tr> <td>0</td> <td>1</td> <td>10.725</td> </tr> <tr> <td>1</td> <td>0</td> <td>10.650</td> </tr> <tr> <td>1</td> <td>1</td> <td>10.675</td> </tr> </tbody> </table>	IF1	IF0	IF	0	0	10.700 MHz	0	1	10.725	1	0	10.650	1	1	10.675
IF1	IF0	IF														
0	0	10.700 MHz														
0	1	10.725														
1	0	10.650														
1	1	10.675														
WITH LW	<p>By setting this switch preset memories are divided into as follows.</p> <p>OFF (0) : FM (M1 to M7), MW (M1 to M7)</p> <p>ON (1) : FM (M1 to M7), MW (M1 to M4), LW (M5 to M7)</p>															
STATIC/DYNA	<p>OFF (0) : multiplex drive display</p> <p>ON (1) : static drive display</p> <p>In the case of static drive display, DATA signal is output from SEGMENT S<sub>C</sub> terminal, clock signal from DIGIT <math>\overline{D}_1</math>, and LOAD signal from <math>\overline{D}_2</math> terminal.</p> <p>(See 2. Display)</p>															

## ALTERNATE SWITCH

There are two kinds of alternate switch:

SYMBOL	DESCRIPTION																																																																																
CH/FREQ	<p>Selecting switch for frequency or channel display of the FM band.</p> <p>OFF (0) : to display the FM frequency</p> <p>ON (1) : to display the FM channel</p> <p>The following is corresponding table of frequency and channel.</p> <p>For example, "88.00 MHz" is display "+3 CH" by switching this switch.</p> <table border="1" data-bbox="443 478 1243 1129"> <thead> <tr> <th>Frequency</th> <th>Channel</th> <th>Frequency</th> <th>Channel</th> </tr> </thead> <tbody> <tr> <td>87.50 MHz</td> <td>-2 CH</td> <td>96.05 MHz</td> <td>+30 CH</td> </tr> <tr> <td>87.55</td> <td>-2</td> <td>96.10</td> <td>+30</td> </tr> <tr> <td>87.60</td> <td>2</td> <td>96.15</td> <td>+30</td> </tr> <tr> <td>87.65</td> <td>+2</td> <td>96.20</td> <td>-40</td> </tr> <tr> <td>87.70</td> <td>+2</td> <td>96.25</td> <td>-40</td> </tr> <tr> <td>87.75</td> <td>+2</td> <td></td> <td></td> </tr> <tr> <td>87.80</td> <td>-3</td> <td>107.45</td> <td>+68</td> </tr> <tr> <td>87.85</td> <td>-3</td> <td>107.50</td> <td>+68</td> </tr> <tr> <td>87.90</td> <td>3</td> <td>107.55</td> <td>+68</td> </tr> <tr> <td>87.95</td> <td>+3</td> <td></td> <td></td> </tr> <tr> <td>88.00</td> <td>+3</td> <td>107.60</td> <td>-69</td> </tr> <tr> <td>88.05</td> <td>+3</td> <td>107.65</td> <td>-69</td> </tr> <tr> <td>88.10</td> <td>-4</td> <td>107.70</td> <td>69</td> </tr> <tr> <td>88.15</td> <td>-4</td> <td>107.75</td> <td>+69</td> </tr> <tr> <td>88.20</td> <td>4</td> <td>107.80</td> <td>+69</td> </tr> <tr> <td></td> <td></td> <td>107.85</td> <td>+69</td> </tr> <tr> <td></td> <td></td> <td>107.90</td> <td>-70</td> </tr> <tr> <td>96.00</td> <td>30</td> <td>107.95</td> <td>-70</td> </tr> <tr> <td></td> <td></td> <td>108.00</td> <td>70</td> </tr> </tbody> </table>	Frequency	Channel	Frequency	Channel	87.50 MHz	-2 CH	96.05 MHz	+30 CH	87.55	-2	96.10	+30	87.60	2	96.15	+30	87.65	+2	96.20	-40	87.70	+2	96.25	-40	87.75	+2			87.80	-3	107.45	+68	87.85	-3	107.50	+68	87.90	3	107.55	+68	87.95	+3			88.00	+3	107.60	-69	88.05	+3	107.65	-69	88.10	-4	107.70	69	88.15	-4	107.75	+69	88.20	4	107.80	+69			107.85	+69			107.90	-70	96.00	30	107.95	-70			108.00	70
Frequency	Channel	Frequency	Channel																																																																														
87.50 MHz	-2 CH	96.05 MHz	+30 CH																																																																														
87.55	-2	96.10	+30																																																																														
87.60	2	96.15	+30																																																																														
87.65	+2	96.20	-40																																																																														
87.70	+2	96.25	-40																																																																														
87.75	+2																																																																																
87.80	-3	107.45	+68																																																																														
87.85	-3	107.50	+68																																																																														
87.90	3	107.55	+68																																																																														
87.95	+3																																																																																
88.00	+3	107.60	-69																																																																														
88.05	+3	107.65	-69																																																																														
88.10	-4	107.70	69																																																																														
88.15	-4	107.75	+69																																																																														
88.20	4	107.80	+69																																																																														
		107.85	+69																																																																														
		107.90	-70																																																																														
96.00	30	107.95	-70																																																																														
		108.00	70																																																																														
AUTO/MANUAL	<p>Selecting switch for auto tuning or manual tuning.</p> <p>OFF (0) : Manual tuning</p> <p>ON (1) : Auto tuning</p> <p>Each tuning operation starts by depressing UP/DOWN momentary switch after setting this switch. (See. momentary/alternate switch on page 12)</p> <p>Note 1: The searching operation continues even if this switch is changed into MANUAL mode during AUTO TUNING mode. If searching operation is required to stop at the same time changing from AUTO to MANUAL, high level signal should be always input to SD terminal during MANUAL mode.</p> <p>Note 2: In Auto tuning mode, the <math>\mu</math>PD1703C-015 increases or decreases frequency step by step confirming that the PLL system is completely locked, in order to scan the band as fast as possible. Therefore if the PLL system is malfunctioning and is not locked, the <math>\mu</math>PD1703C-015 halts the AUTO tuning operation and waits for the PLL to be locked. In this condition, all the keys are not accepted. To escape this condition, force CE terminal to low level then high level, and the frequency can be varied by manual tuning.</p> <p>In the recommended application, the CE terminal is to be connected to the main-power-supply of the set. So the end user can vary the frequency after operating the power-supply-switch, even if the above malfunction occurs.</p>																																																																																

### MOMENTARY/ALTERNATE SWITCH

Either momentary or alternate switch can be used for PRESET KEY (  to  ) and BAND SWITCH KEY ( , ,  ).

If alternate switch is used for PRESET KEY, it should be connected with operation of  or  key.

SYMBOL	DESCRIPTION
<div style="border: 1px solid black; padding: 5px; width: fit-content;">EXTERNAL DATA PRESET</div>	<p>This switch is provided for writing the FM, MW frequency data into the PRESET memory (M1 to M7) from external microprocessor. This is useful to check the function of varactor tuned tuner using this IC at the massproduction.</p> <p>The following five terminals are used for data transfer.</p> <p>K0 to K3 ..... input terminal of frequency data (4 bit parallel input)</p> <p>SD ..... input terminal for indicating of signal receipt. (See 6. EXTERNAL DATA PRESET)</p>
<div style="border: 1px solid black; padding: 5px; width: fit-content;">MEMORY</div>	<p>This is used to write a new frequency into preset memory. If any one of the memory key, <input type="text" value="M1"/> to <input type="text" value="M7"/>, is depressed within 5 sec. after this key is depressed, the displayed frequency is written into the memory corresponding to depressed memory key. In order to cancell the state that memory is ready to be written, press the <input type="text" value="UP"/> / <input type="text" value="DOWN"/> key or change the band of FM, MW, or LW.</p>
<div style="border: 1px solid black; padding: 5px; width: fit-content; margin-bottom: 10px;">UP</div> <div style="border: 1px solid black; padding: 5px; width: fit-content;">DOWN</div>	<p>These key for automatic or manual tuning.</p> <p>(1) If AUTO/MANUAL switch is set in 'AUTO':</p> <ul style="list-style-type: none"> <li>○ The depression of up key will result in traversing up the complete band at the speed of 80 ms/step. If the top of the band is reached the searching operation will turn to traverse down. (Triangle-wave tuning) If the SD terminal receive high level signal during traversing the band, searching operation will be stopped. If the <input type="text" value="DOWN"/> key is depressed during searching up, traversing turns downward.</li> <li>○ The depression of <input type="text" value="DOWN"/> key will result in completely reversed operation mentioned above.</li> </ul> <p>Note: If the UP key is depressed during the searching up operation, or the DOWN key during down operation, each searching operation will be continued. Continuous depression of UP, DOWN key will result in continuous searching even if the SD terminal receive the high level signal.</p> <p>(2) If AUTO/MANUAL switch is set in 'MANUAL':</p> <ul style="list-style-type: none"> <li>○ Each one depression of <input type="text" value="UP"/> or <input type="text" value="DOWN"/> key will result in traversing one step (or channel spacing) up or down.</li> <li>○ If the <input type="text" value="UP"/> or <input type="text" value="DOWN"/> key is continuously depressed over 0.5 sec., the band is traversed upward or downward at the speed of 80 ms/step until the key is released.</li> </ul> <p>* If the band edge is reached, searching operation will stop. Even if AUTO/MANUAL switch is set to MANUAL during auto tuning operation, auto tuning operation is not stopped. If SD terminal always is input high level signal when AUTO/MANUAL switch is MANUAL, auto tuning operation is stopped at the same time that MANUAL switching.</p>

**SYMBOL**

**DESCRIPTION**

These keys are provided to write/read preset memories.  
 Each memory memorizes one station each of FM and MW band.  
 (WITH LW key: OFF)  
 If the WITH LW key is on, M1 through M4 memorizes FM and MW band, and M5 through M7 are of FM and LW.

WITH LW: ON

M1	M2	M3	M4	M5	M6	M7
FM	FM	FM	FM	FM	FM	FM
MW	MW	MW	MW	LW	LW	LW

WITH LW: OFF

M1	M2	M3	M4	M5	M6	M7
FM	FM	FM	FM	FM	FM	FM
MW	MW	MW	MW	MW	MW	MW

M1

to

M7

**(1) WRITE IN:**

If one of the memory keys from  through  is depressed within 5 sec. after depression of MEMORY key, new frequency is written in a memory corresponding depressed key.

If WITH LW key is set 'ON', M1 to M4 accept the station of FM and MW, M5 through M7 accept of FM and LW. In this case M1 through M4 and M5 through M7 can not accept LW band and MW band respectively.

**(2) READ OUT:**

If one of the memory keys from M1 through M7 is depressed, the content of the memory corresponding depressed key is read out.

If the WITH LW key is ON, no action occurs by the depression of one key from  through  at receiving of LW band or M5 through M7 at MW band.

By depressing these preset keys the mute signal of approximately 450 ms duration is output.

(See 4.2 MUTE TIMING CHART)

\* The minimum frequency of FM is read out when V<sub>DD</sub> is on for the first time.

Preset memory is write in the minimum frequency of each bands (FM, MW, LW) at this time.

FM

MW

LW

These are for selection of frequency band. Either of momentary or alternate type is acceptable for these switches. The mute signal of approximately 850 ms duration will be output when the band is changed.

## 2. DISPLAY

### 2.1 MULTIPLEX DRIVE DISPLAY

The following figure shows display format and connection with pins of  $\mu$ PD1703C-015 in case of multiplex drive display (STATIC/DYNA key is OFF).

The pins of  $D_1$  through  $D_5$  and  $S_a$  through  $S_g$  in the figure are corresponding the digit terminal ( $\bar{D}_1$  to  $\bar{D}_5$ ) and segment ( $S_a$  to  $S_g$ ) of  $\mu$ PD1703C-015, respectively.

The segment terminal of  $\mu$ PD1703C-015 has 30 V output voltage (Pch open drain output) to be directly connected with FIP. To drive the digits one buffer amplifier by P N P transistor is required for digit drive because the digit output of  $\mu$ PD1703C-015 is complementary and active low signal is output.

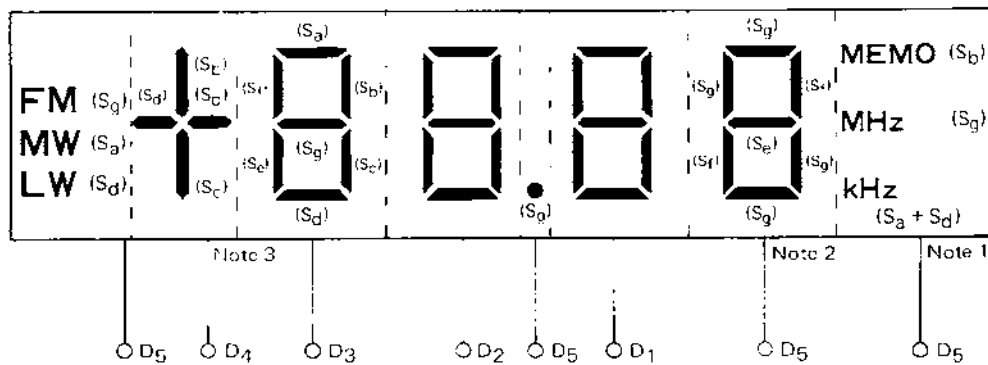

Fig. 1 Multiplex drive display connection diagram

**Note 1:** The indication of "kHz" is displayed by OR-signal of  $S_a$  and  $S_d$ . In case of without LW it can be displayed by  $S_a$ .

**Note 2:** This digit is provided for the tenth digit of FM 50 kHz. (only "5" or "0") There is no display in MW and LW band.

**Note 3:** This digit is for display "5" (the upper or most left digit of frequency) or "FM", "--" of FM channel.

Followings are examples of display using the format of Fig. 1.

(1) Indication of FM frequency:

FM 89.45 MHz

(2) Indication of FM channel number:

FM + 37

(3) Indication of MW frequency:

MW 1620 MEMO Note  
kHz

(4) Indication of LW frequency:

LW 200 kHz

**Note:** If the **MEMORY** key is depressed, (or new frequency is written in the memory) this 'MEMO' display is turn on during 5 sec. If one of preset station keys from **M1** through **M7** is depressed within 5 sec., the new frequency is written and then MEMO display is turn off.

## 2.2 STATIC DISPLAY

If the STATIC/DYNA key is set on, DATA signal is output from  $S_C$  segment terminal, CLOCK signal from digit  $D_1$ , and LOAD signal from  $D_2$  terminal. The DATA signal is serially output by one bit at a time in the sequence shown below.

Output order	1	2	3	4	5	6	7	8	9	10	11	12	13	14	15	16	17	18	19	20	21	22	23	24	
Display kind	--	LW	S	O	MFM	MW	FM			BCD 100 kHz				BCD 1 MHz				BCD 10 MHz				BCD preset station display			
									0	1	2	4	0	1	2	4	0	1	2	4	0	1	2	4	

The CLOCK signal corresponding to one bit of DATA signal makes the data shifted by one bit. If the BCD, binary coded decimal, data for preset station display completes to be shifted, LOAD signal is output and then the static converting has finished. The figure 2 shows the timing in this process.

The CLOCK and LOAD signal are shown as active high signal through inverter from  $\overline{D_1}$ ,  $\overline{D_2}$  terminal.

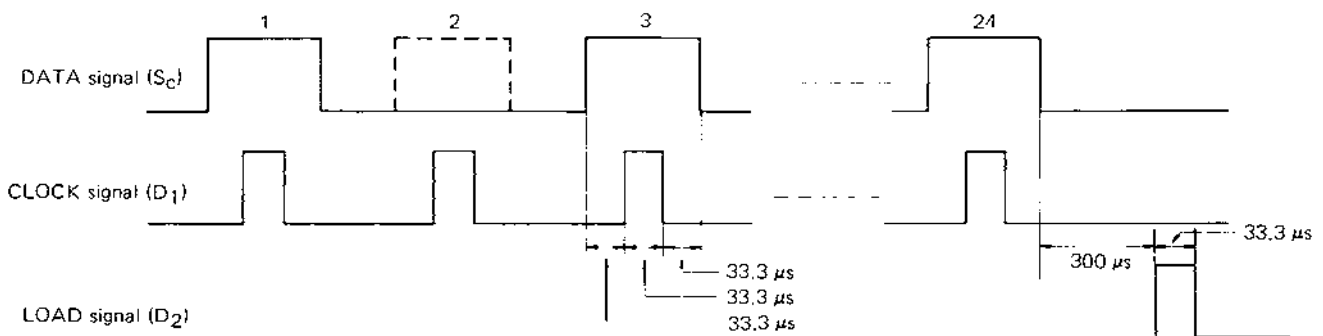

Fig. 2 Timing chart

These pulse sequence is output when the switch changing the contents of display is depressed, and after that it is output at 5 sec. intervals.

Followings are examples of static display.

In these examples high level output is shown in '1' and low level in '0'.

Ex. 1 FM 104.30 MHz

Output order	1	2	3	4	5	6	7	8	9	10	11	12	13	14	15	16	17	18	19	20	21	22	23	24	
Display kind	--	LW	5	0	MEM	MW	FM		BCD 100 kHz				BCD 1 MHz			BCD 10 MHz			BCD preset station display						
Output level	0	0	0	1	0	0	1	1	1	1	0	0	0	0	1	0	0	0	0	0	0	0	1	0	0
									1			3			4			0			2(M2)				

Ex. 2 FM +57 ch

Output order	1	2	3	4	5	6	7	8	9	10	11	12	13	14	15	16	17	18	19	20	21	22	23	24	
Display kind	--	LW	5	0	MEM	MW	FM		BCD 1 ch				BCD 10 ch			Blank			BCD preset station display						
Output level	0	1	0	0	0	0	0	0	0	0	1	0	0	1	1	0	1	0	0	0	1	1	1	0	
									+				7			5			F (Blank)			0 (last channel)			

Ex. 3 LW 164 kHz

Output order	1	2	3	4	5	6	7	8	9	10	11	12	13	14	15	16	17	18	19	20	21	22	23	24
Display kind	--	LW	5	0	MEM	MW	FM		BCD 1 kHz				BCD 10 kHz			BCD 100 kHz			BCD preset station display					
Output level	0	1	0	0	0	0	0	0	0	0	1	0	0	1	1	0	1	0	0	0	1	1	1	0
									4				6			1			7(M7)					

Ex. 4 MW 810 kHz

Output order	1	2	3	4	5	6	7	8	9	10	11	12	13	14	15	16	17	18	19	20	21	22	23	24
Display kind	--	LW	5	0	MEM	MW	FM		BCD 1 kHz				BCD 10 kHz			BCD 100 kHz			BCD preset station display					
Output level	0	0	0	0	0	1	0	0	0	0	0	0	1	0	0	0	0	0	0	1	1	1	0	0
									0				1			8			3(M3)					

### 3. PRESET STATION DISPLAY (Note)

BCD code is transmitted from  $S_e$  to  $S_g$  at timing of digit signal  $\overline{D}_4$ .

An example is shown in Fig. 3, and the timing chart in Fig. 4.

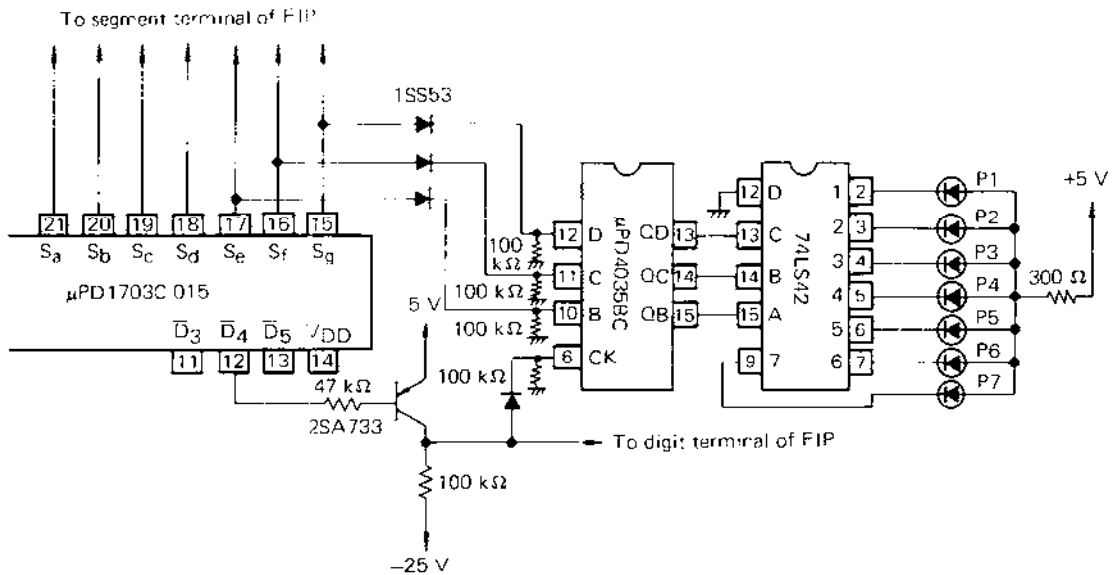

Fig. 3 Example of preset station display connection

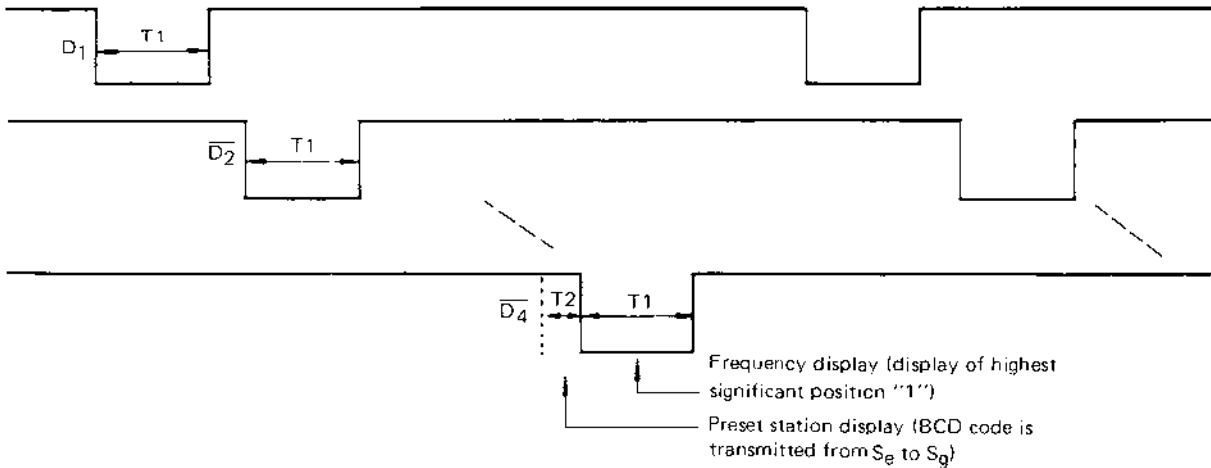

Fig. 4 Timing chart

At the timing  $T_1$  of digit signal  $\overline{D}_4$ ,  $S_b$  and  $S_c$  provide the display signal of '1', upper digit of frequency. At the timing of  $T_2$ ,  $S_e$  to  $S_g$  provide BCD output to display the preset station.

Note: The preset stations are indicated by 7 discrete LED's (P1 to P7) by depressing corresponding PRESET keys (  to  ).

As shown in Fig. 4, these BCD output is multiplex, it is required to be converted to static drive output. The  $\mu$ PD4035C is a D-F/F for this purpose. In order to latch  $\mu$ PD4035C by rising signal of digit  $\overline{D}_4$ , active high, the digit output of  $\mu$ PD1703C-015 should be inverted.

Output status of segment terminal,  $S_a$  to  $S_g$  at the timing T1, T2 of digit  $D_4$

SEGMENT TIMING	$S_a$	$S_b$	$S_c$	$S_d$	$S_e$	$S_f$	$S_g$
T1	blank	display '1' of upper digit		blank	blank	blank	blank
T2	blank	blank	blank	blank	BCD output		

Preset station BCD code output

$S_g$	$S_f$	$S_e$	PRESET CHANNEL
0	0	1	P1 (M1 key)
0	1	0	P2 (M2 key)
0	1	1	P3 (M3 key)
1	0	0	P4 (M4 key)
1	0	1	P5 (M5 key)
1	1	0	P6 (M6 key)
1	1	1	P7 (M7 key)

## 4. TIMING CHART

### 4.1 DISPLAY AND TAKING IN

(1)  $\bar{D}_1$  to  $\bar{D}_3, \bar{D}_5$

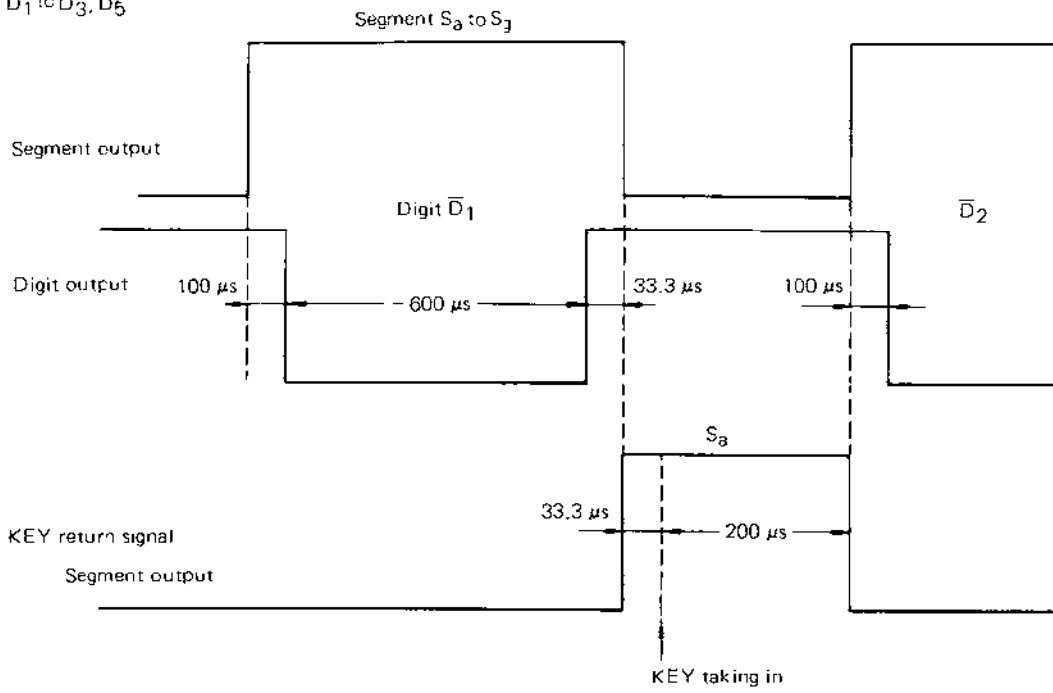

(2)  $\bar{D}_4$

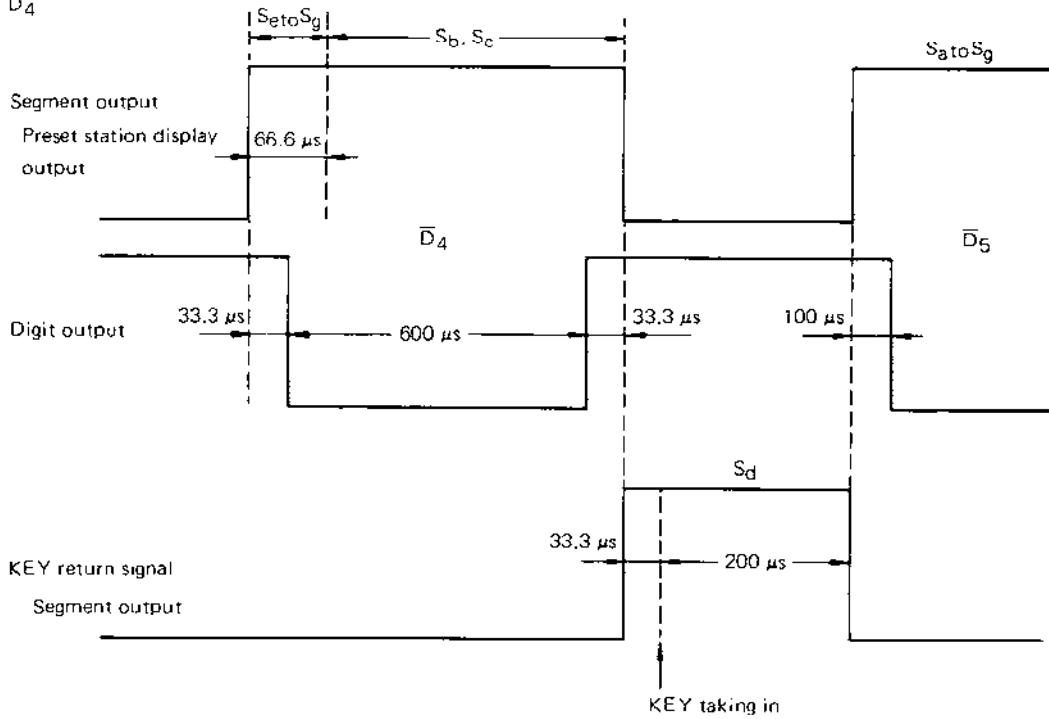

## 4.2 MUTE TIMING CHART

- ① Key ON chattering preventing time
- ② Mute leading time
- ③ Division ratio setting and display content updating time
- ④ Mute trailing time
- ⑤ Scan time
- ⑥ PLL lock up time

### (1) Manual up/down

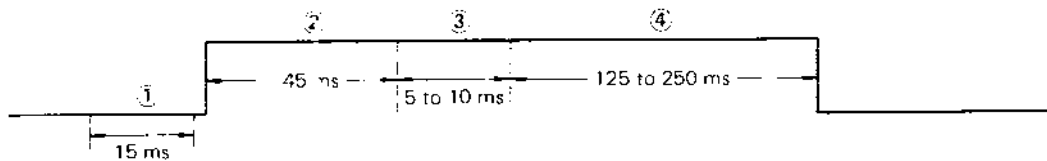

### (2) Auto up/down

When SD signal is input:

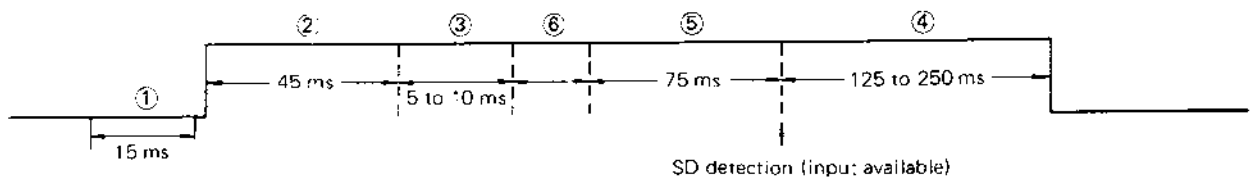

When no SD signal is input

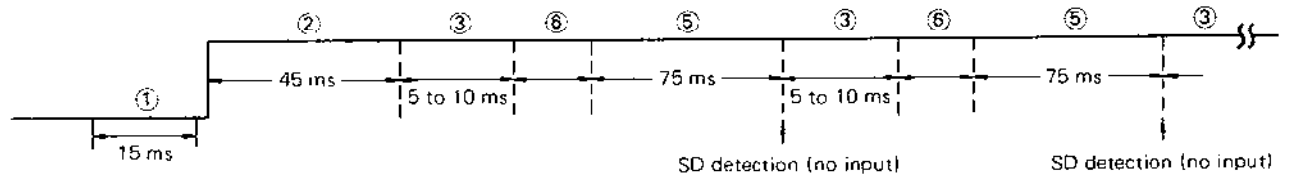

### (3) Preset memory call

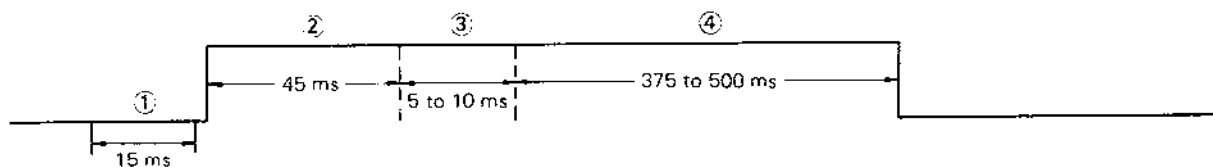

### (4) When FM/MW/LW are switched and power is ON (CE = Low High)

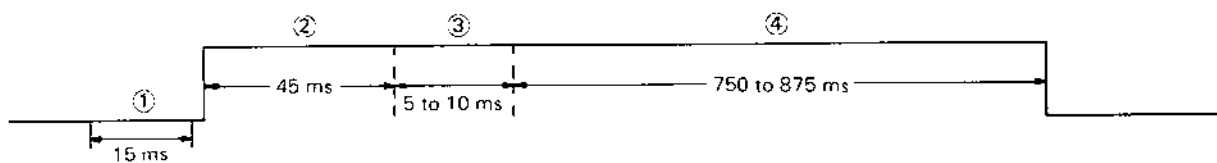

## 5. APPLICATION OF BAND SELECTION

If the momentary switch is used for band selection of FM, MW, LW, it is possible to switch over power supply of the tuner as shown below. The character display output signal, "FM", "MW", "LW", are used to be input of above circuits.

The active high signal is feeded through a buffer, consist of one PNP transistor, from  $\overline{D}_5$  terminal of  $\mu\text{PD1703C-015}$  and used to be CLOCK signal ( $\overline{D}_5$ ).

### Application I

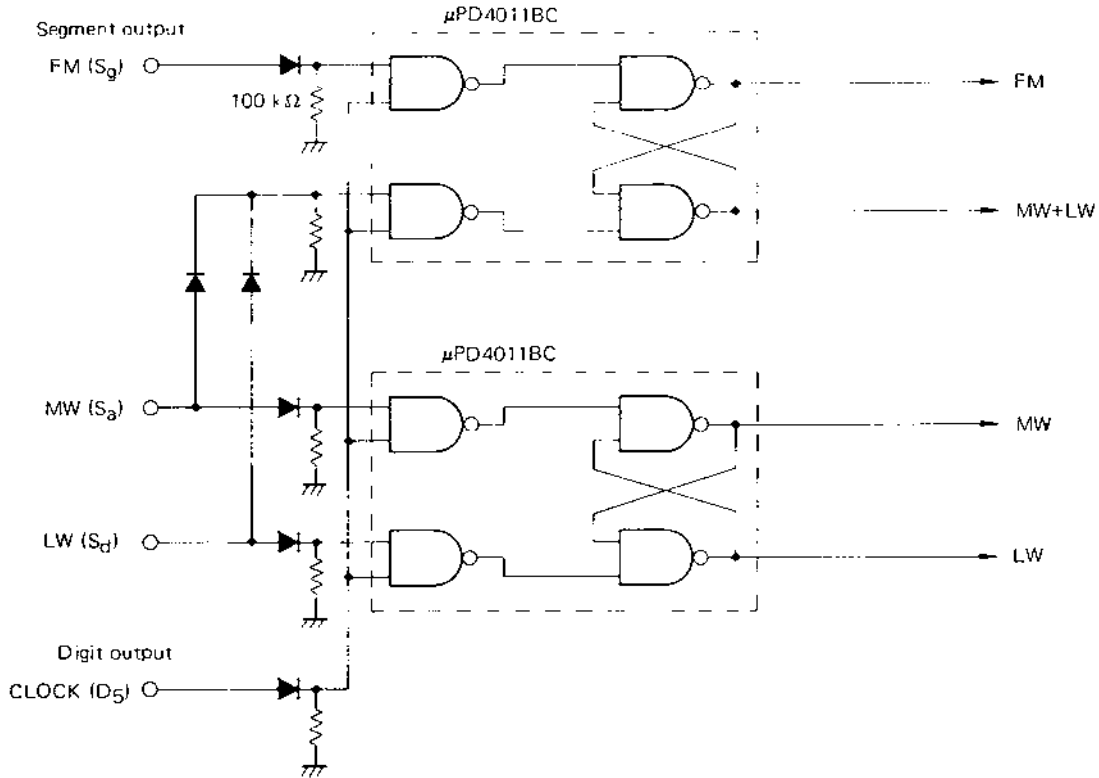

### Application II

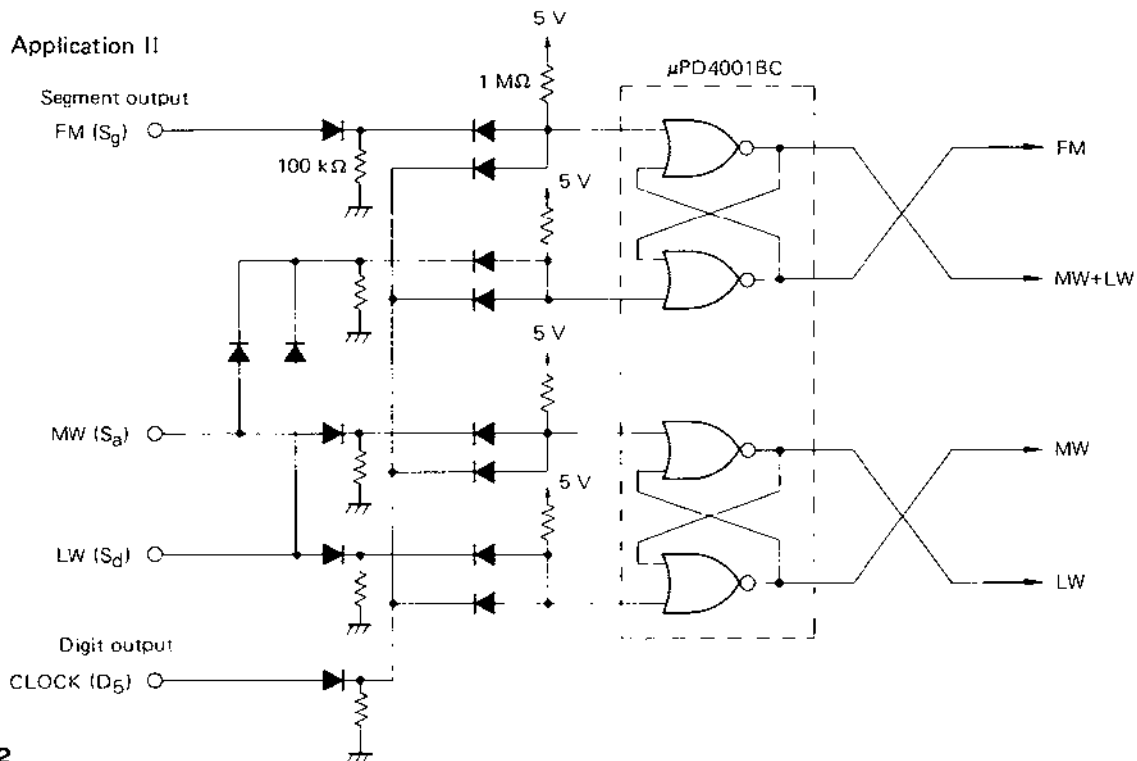

## 6. EXTERNAL DATA PRESET

The frequency information consisted by 8 bits data is stored into the FM, MW preset memories (M1 to M7) through key inputs (K0 to K3) of  $\mu$ PD1703C-015 from external microprocessor, such as TK-80, etc.

The frequency data consists of channel number coded in 8 bits; these 8 bits data are divided into two 4 bits portion – "DATA H" and "DATA L". Any frequency in the radio band – FM: 87.50 to 108.00 MHz, MW: 522 to 1 611 kHz – can be stored.

Fig. 5 shows flow chart of  $\mu$ PD1703C-015.

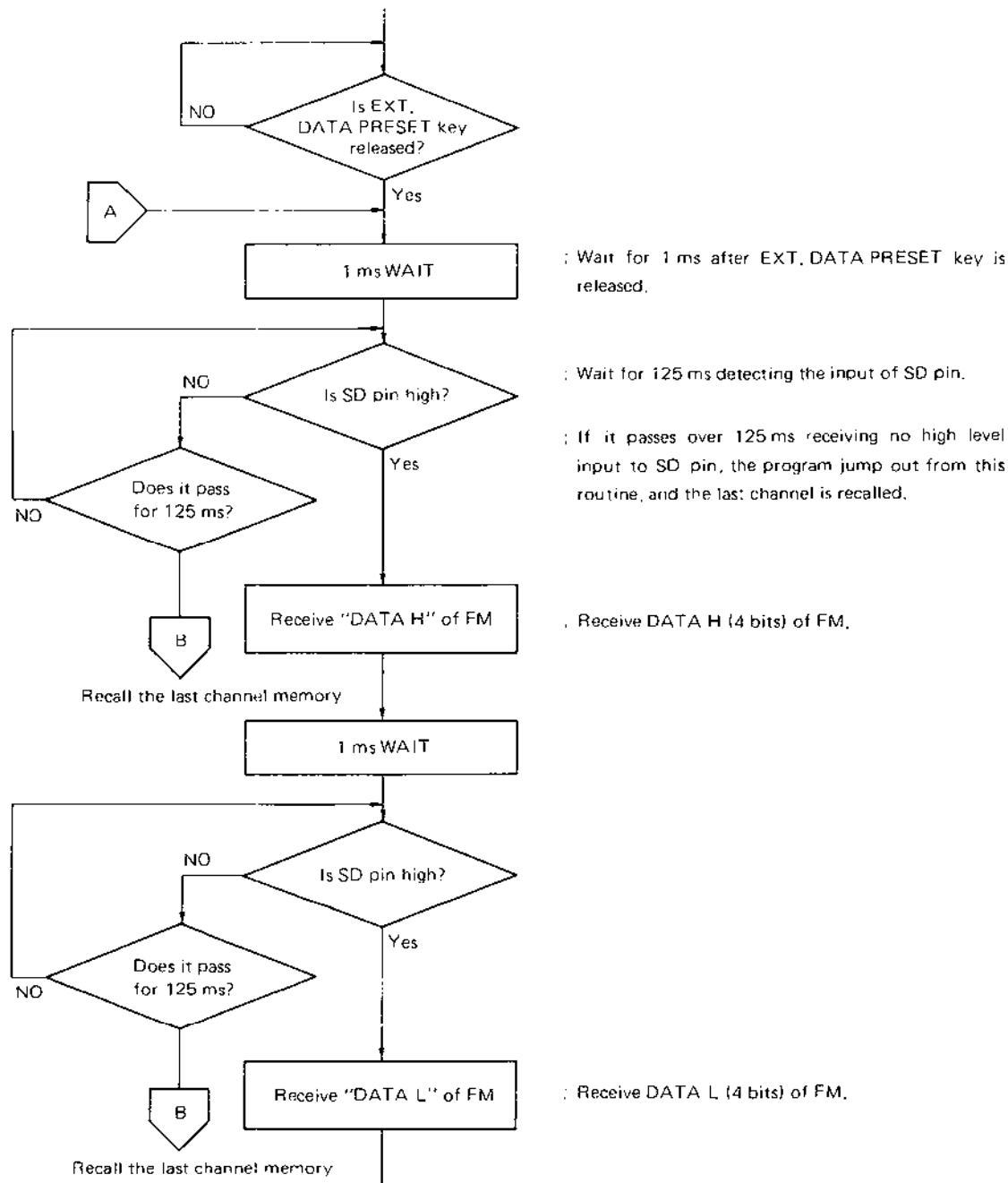
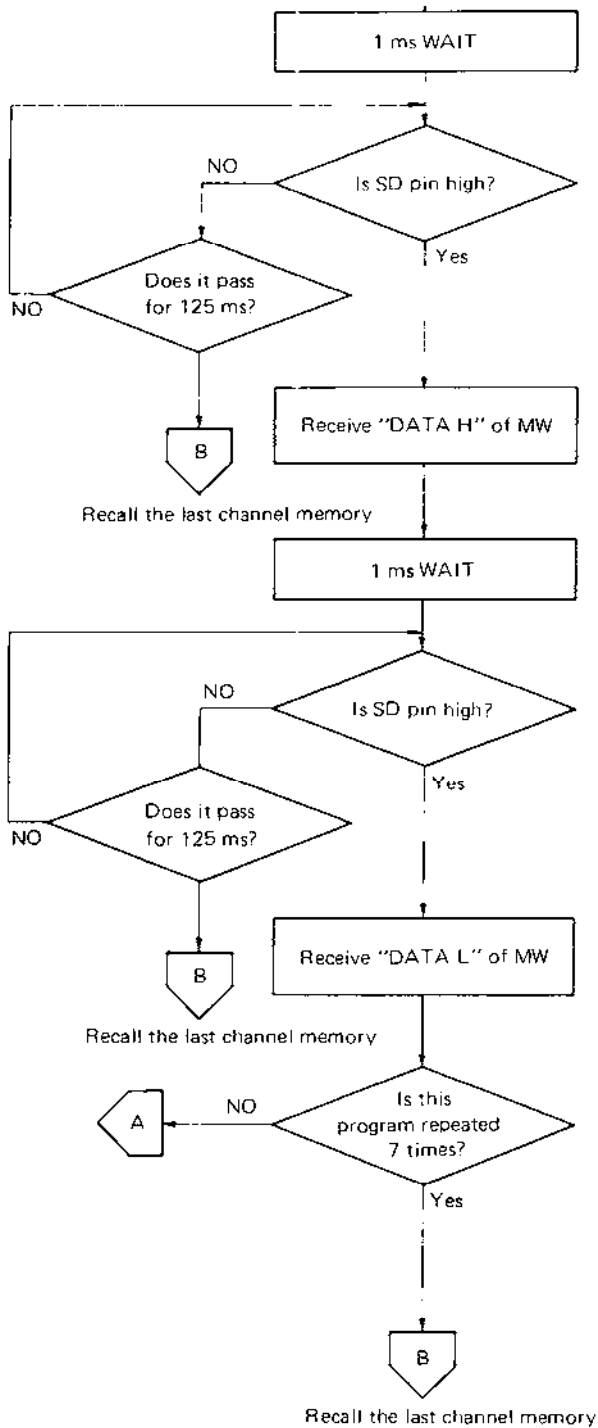

Fig. 5 Flow chart of external data preset



; Occupy DATA of MW after this.

; Receive DATA H (4 bits) of MW.

; Receive DATA L (4 bits) of MW.

; After the preset memories, M1 through M7 are occupied by the data, this procedure go out from this flow to another mode which recall the last channel memory.

Table 2. EXT. DATA PRESET frequency data (channel number)

DATA H	DATA L	FM Freq.	MW Freq.
0	0	87.50 MHz	522 kHz
0	1	87.60	531
0	2	87.70	540
0	3	87.80	549
0	4	87.90	558
0	5	88.00	567
0	6	88.10	576
0	7	88.20	585
0	8	88.30	594
0	A	88.40	603
0	B	88.50	612
0	C	88.60	621
0	D	88.70	630
0	E	88.80	639
0	F	88.90	648
1	0	89.00	657
1	1	89.10	666
1	2	89.20	675
7	7	99.40	1493
7	8	99.50	1502
7	9	99.60	1611
7	A	99.70	1611
7	B	99.80	1611
C	9	107.60	1611
C	A	107.70	1611
C	B	107.80	1611
C	C	107.90	1611
C	D	108.00	1611

Note: DATA H, L is HEX decimal code.

# 7. APPLICATION CIRCUIT

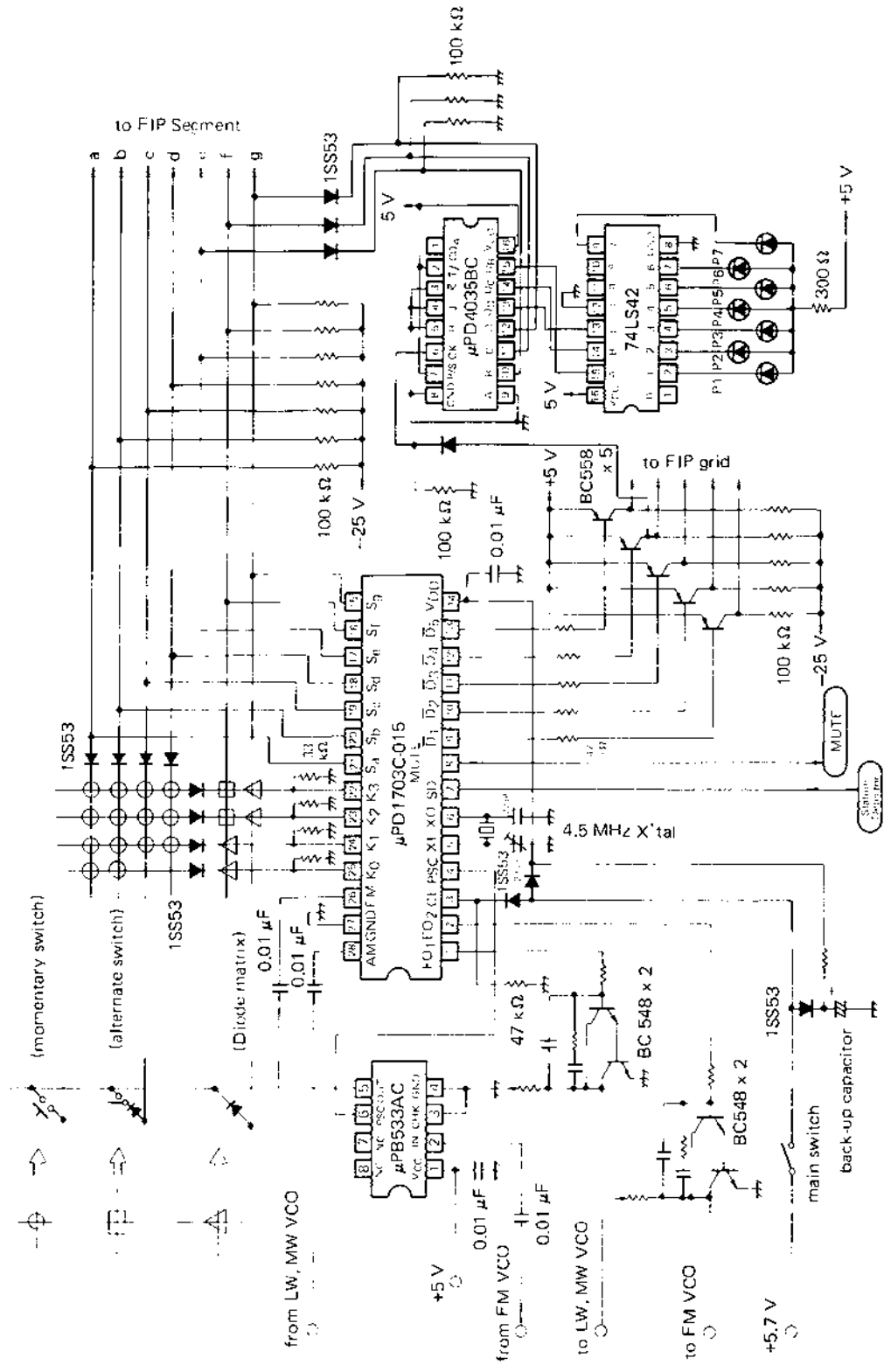

The applied circuits and circuit constants listed in this material are not intended for mass production design with deviations and temperature characteristics of component parts considered. Further, this company will not assume any responsibility as regards the patents on the circuits listed in this material.

## 8. ELECTRICAL CHARACTERISTICS

### 8.1 ABSOLUTE MAXIMUM RATINGS

Supply voltage	$V_{DD}$	-0.3 to +6.0	V
Input voltage	$V_I$	-0.3 to + $V_{DD}$	V
Output voltage	$V_O$	-0.3 to + $V_{DD}$	V
Output absorption current	$I_O$	10	mA
Operating temperature	$T_{OPT}$	-35 to +75	°C
Storage temperature	$T_{stg}$	-55 to +125	°C
Withstanding output voltage	$V_{BDS}$	$S_a$ to $S_g$ terminals -35 (Inter-drain source voltage)	V

### 8.2 RECOMMENDED OPERATING CONDITIONS

CHARACTERISTIC	SYMBOL	MIN.	TYP.	MAX.	UNIT	CONDITION
Supply voltage	$V_{DD}$	4.5	5.0	5.5	V	
RAM retention voltage	$V_{RAM}$	2.5			V	CE terminal = 0
Withstanding output voltage	$V_{BDS}$			-30	V	$S_a$ to $S_g$ terminals (Inter-drain source voltage) $I_{OFF} = -5 \mu A$
Supply voltage rise time	$T_{rise}$			500	ms	$V_{DD} = 0 \rightarrow 4.5 V$

### 8.3 DC CHARACTERISTICS ( $V_{DD} = +4.5$ to $+5.5$ V, $T_a = -35$ to $+75$ °C)

CHARACTERISTIC	SYMBOL	MIN.	TYP.	MAX.	UNIT	CONDITION
High level input voltage	$V_{IH1}$	$0.8 V_{DD}$		$V_{DD}$	V	SD terminal
High level input voltage	$V_{IH2}$	$0.7 V_{DD}$		$V_{DD}$	V	CE terminal
High level input voltage	$V_{IH3}$	$0.6 V_{DD}$		$V_{DD}$	V	K <sub>0</sub> to K <sub>3</sub> terminals
Low level input voltage	$V_{IL1}$	0		$0.3 V_{DD}$	V	CE terminal
Low level input voltage	$V_{IL2}$	0		$0.2 V_{DD}$	V	SD, K <sub>0</sub> to K <sub>3</sub> terminals
High level output voltage	$V_{OH1}$	4.0			V	PSC, MUTE, D <sub>1</sub> to D <sub>5</sub> terminals $I_{OH} = -0.2$ mA
High level output voltage	$V_{OH2}$	4.0			V	EO <sub>1</sub> , EO <sub>2</sub> terminals $I_{OH} = -0.5$ mA
High level output voltage	$V_{OH3}$	3.0			V	S <sub>a</sub> to S <sub>g</sub> terminals $I_{OH} = -0.5$ mA
Low level output voltage	$V_{OL1}$			0.5	V	EO <sub>1</sub> , EO <sub>2</sub> terminals $I_{OL} = 0.5$ mA
Low level output voltage	$V_{OL2}$			0.5	V	MUTE, D <sub>1</sub> to D <sub>5</sub> , PSC terminals $I_{OL} = 0.2$ mA
High level input current	$+I_{IH1}$	5.0	25	100	μA	K <sub>0</sub> to K <sub>3</sub> terminals $V_{IN} = V_{DD} = 5.0$ V
High level input current	$+I_{IH2}$		300		μA	X <sub>1</sub> terminal $V_{IN} = V_{DD} = 5.0$ V
Low level input current	$-I_{IL1}$		300		μA	AM, FM terminals $V_{IN} = 0$ V, $V_{DD} = 5.0$ V
Output leakage current	$I_L$		$10^{-3}$	1	μA	EO <sub>1</sub> , EO <sub>2</sub> terminals $V_O = V_{DD} = 5.0$ V
AC input voltage	$V_{in}$	1.0		$V_{DD}$	V <sub>p-p</sub>	AM, FM terminals
Operating current	$I_{DD1}$		3		mA	Normal operation (excluding display current)
Operating current	$I_{DD2}$			10	μA	CE terminal = 0, $T_a = 25$ °C, $V_{DD} = 5$ V
RAM retention voltage	$V_{RAM}$	2.5			V	CE terminal = 0
Withstanding output voltage	$V_{BDS}$			-30	V	S <sub>a</sub> to S <sub>g</sub> terminals (Inter-drain source voltage), $I_{OFF} = -5$ μA

### 8.4 AC CHARACTERISTICS ( $V_{DD} = +4.5$ to $+5.5$ V, $T_a = -35$ to $+75$ °C)

CHARACTERISTIC	SYMBOL	MIN.	TYP.	MAX.	UNIT	CONDITION
Operating Frequency	$f_{AM}$	0.5		2.5	MHz	AM terminal $V_{in} = 1.0$ V <sub>p-p</sub> (MIN.), DC cut
Operating Frequency	$f_{FM}$	0.5		8.8	MHz	FM terminal, $V_{in} = 0.8$ V <sub>p-p</sub> (MIN.), square wave, DC cut

## 9. PACKAGE DIMENSION (Unit: mm)

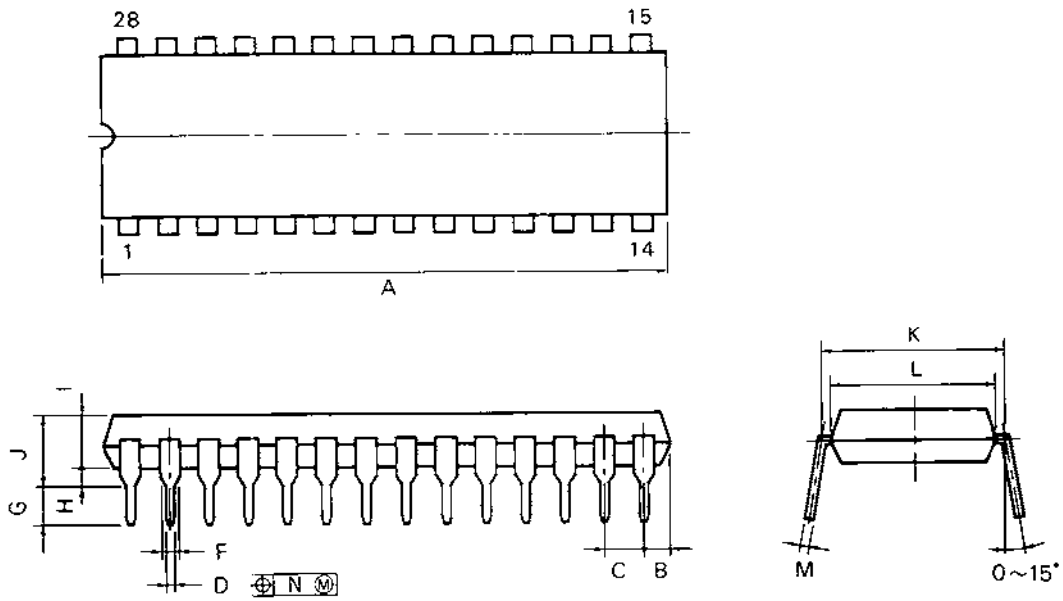

P28C-100-600A1

### NOTES

- 1) Each lead centerline is located within 0.25 mm (0.01 inch) of its true position (T.P.) at maximum material condition.
- 2) Item "K" to center of leads when formed parallel.

ITEM	MILLIMETERS	INCHES
A	38.10 MAX.	1.500 MAX.
B	2.54 MAX.	0.100 MAX.
C	2.54 (T.P.)	0.100 (T.P.)
D	0.50 <sup>+0.10</sup>	0.020 <sup>+0.004</sup>
F	1.2 MIN.	0.047 MIN.
G	3.6 <sup>+0.3</sup>	0.142 <sup>+0.012</sup>
H	0.51 MIN.	0.020 MIN.
I	4.31 MAX.	0.170 MAX.
J	5.72 MAX.	0.226 MAX.
K	15.24 (T.P.)	0.600 (T.P.)
L	13.2	0.520
M	0.25 <sup>+0.10</sup> <sub>-0.05</sub>	0.010 <sup>+0.004</sup> <sub>-0.003</sub>
N	0.25	0.01