

# BIPOLAR ANALOG INTEGRATED CIRCUIT

# $\mu$ PC2712T

### 2.6 GHz WIDE BAND AMPLIFIER

### SILICON BIPOLAR MONOLITHIC INTEGRATED CIRCUIT

#### FEATURES

- High power gain : 20 dB TYP. @ f = 1 GHz
- Excellent frequency response: 2.6 GHz TYP. @ 3 dB down below the gain at 0.1 GHz
- Noise figure : 4.5 dB @ f = 1 GHz
- Single supply voltage : 5 V
- Input and output matching : 50  $\Omega$
- Mini package : 6-pin mini mold

#### ORDERING INFORMATION

PART NUMBER	PACKAGE	SUPPLYING FORM
$\mu$ PC2712T-E3	6-pin mini mold	Embossed tape 8 mm wide. QTY 3 KP/Reel. Pin 1, 2, 3 face to perforation side of the tape.

#### EQUIVALENT CIRCUIT

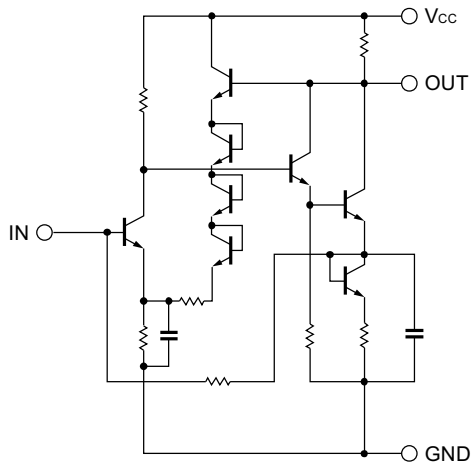

#### PIN CONNECTIONS

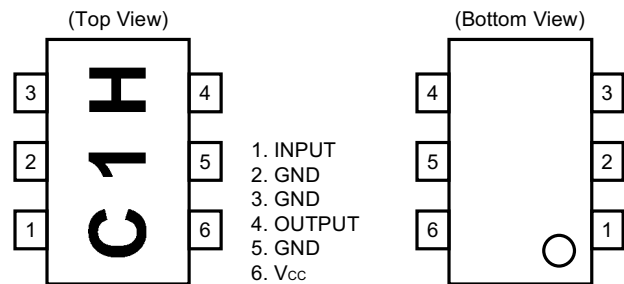

Caution: Electro-static sensitive devices

**ABSOLUTE MAXIMUM RATINGS (Unless otherwise specified, T<sub>A</sub> = +25 °C)**

Supply Voltage	V <sub>CC</sub>	6	V
Total Circuit Current	I <sub>CC</sub>	30	mA
Power Dissipation	P <sub>D</sub>	280*	mW
Operating Ambient Temperature	T <sub>A</sub>	-40 to +85	°C
Storage Temperature	T <sub>stg</sub>	-55 to +150	°C
Input Power	P <sub>in</sub>	+10	dBm

\* Mounted on 50 × 50 × 1.6 mm double sided copper clad epoxy glass PWB (T<sub>A</sub> = +85 °C)

**RECOMMENDED OPERATING CONDITIONS**

PARAMETER	SYMBOL	MIN.	TYP.	MAX.	UNIT
Supply Voltage	V <sub>CC</sub>	4.5	5.0	5.5	V

**ELECTRICAL CHARACTERISTICS (T<sub>A</sub> = +25 °C, V<sub>CC</sub> = 5.0 V, Z<sub>S</sub> = Z<sub>L</sub> = 50 Ω)**

PARAMETERS	SYMBOL	MIN.	TYP.	MAX.	UNIT	TEST CONDITIONS
Circuit Current	I <sub>CC</sub>	9	12	15	mA	No Signals
Power Gain	G <sub>P</sub>	18	20	23.5	dB	f = 1 GHz
Maximum Output Level	P <sub>O(sat)</sub>	0	+3	—	dBm	f = 1 GHz, P <sub>in</sub> = -2 dBm
Noise Figure	NF	—	4.5	6	dB	f = 1 GHz
Upper Limit Operating Frequency	f <sub>u</sub>	2.2	2.6	—	GHz	3 dB down below flat gain at f = 0.1 GHz
Isolation	ISL	28	33	—	dB	f = 1 GHz
Input Return Loss	RL <sub>in</sub>	9	12	—	dB	f = 1 GHz
Output Return Loss	RL <sub>out</sub>	10	13	—	dB	f = 1 GHz
Gain Flatness	ΔG <sub>P</sub>	—	±0.8	—	dB	f = 0.1 to 2.0 GHz

TEST CIRCUIT

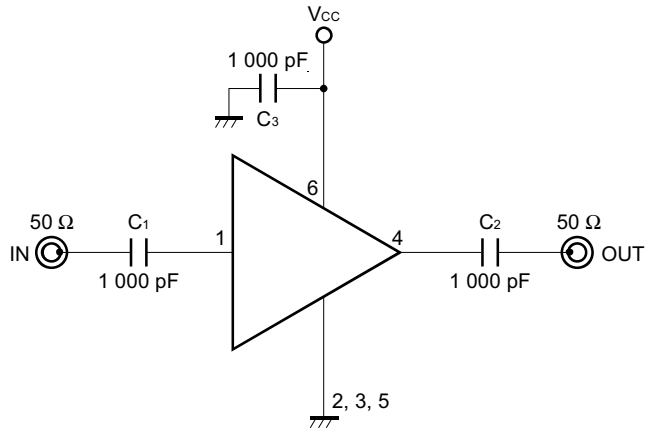

EXAMPLE OF APPLICATION CIRCUIT

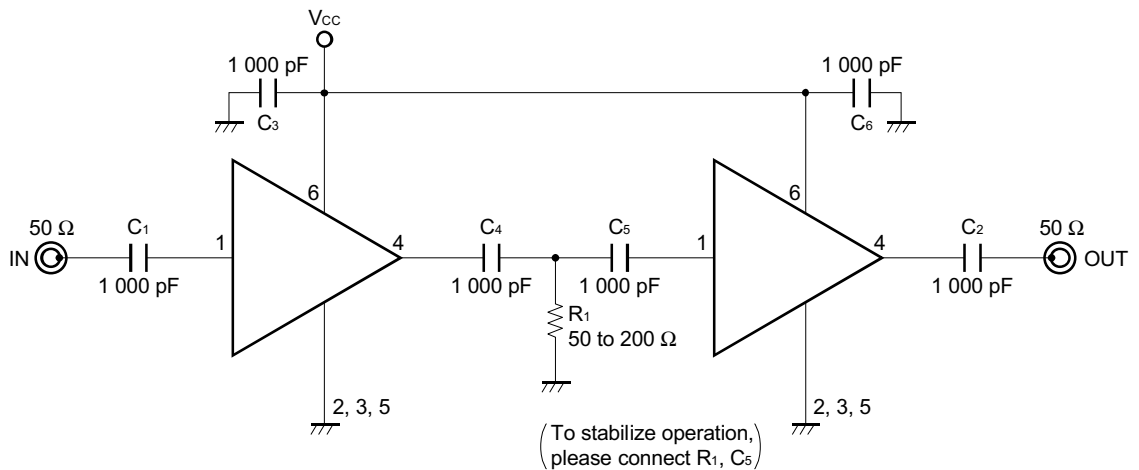

The application circuits and their parameters are for reference only and are not intended for use in actual design-ins.

Capacitors for Vcc, input and output pins

1 000 pF capacitors are recommendable as bypass capacitor for Vcc pin and coupling capacitors for input/output pins.

Bypass capacitor for Vcc pin is intended to minimize Vcc pin's ground impedance. Therefore, stable bias can be supplied against Vcc fluctuation.

Coupling capacitors for input/output pins are intended to minimize RF serial impedance and cut DC.

To get flat gain from 100 MHz up, 1 000 pF capacitors are assembled on the test circuit. [Actually, 1 000 pF capacitors give flat gain at least 10 MHz. In the case of under 10 MHz operation, increase the value of coupling capacitor such as 2 200 pF. Because the coupling capacitors are determined by the equation of  $C = 1/(2 \pi fZ_s)$ .]

TYPICAL CHARACTERISTICS ( $T_A = +25\text{ }^\circ\text{C}$ )

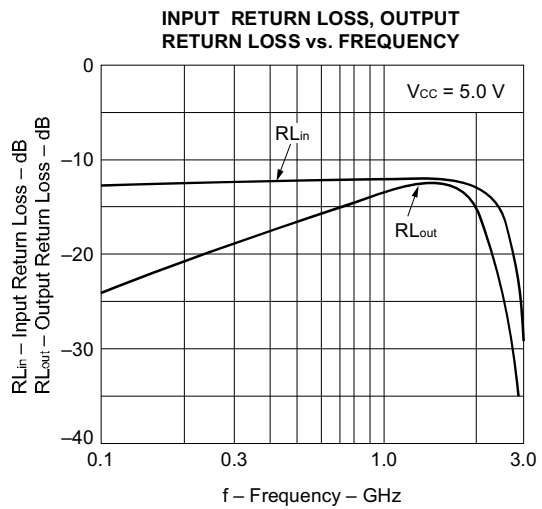
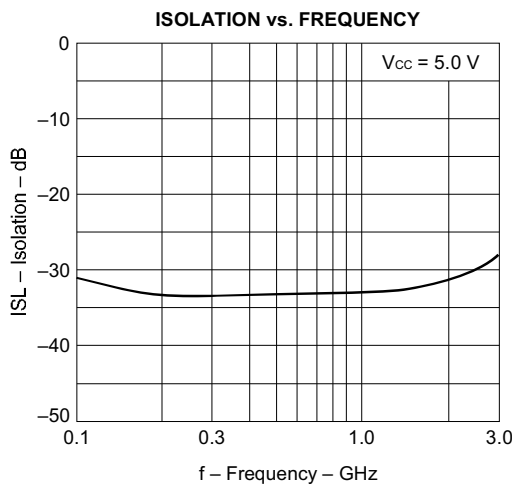
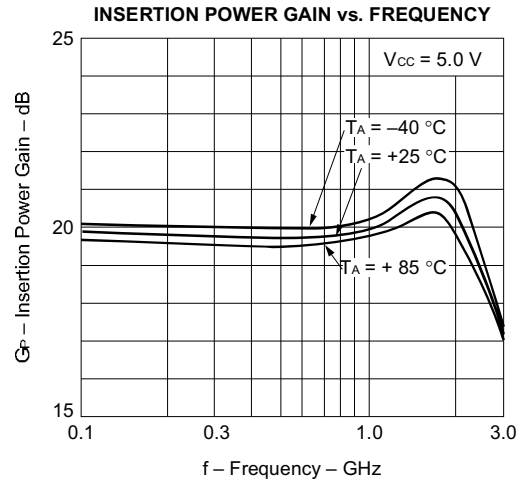
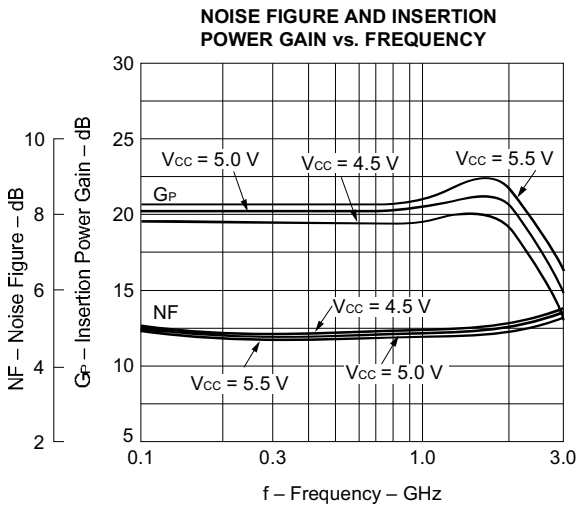
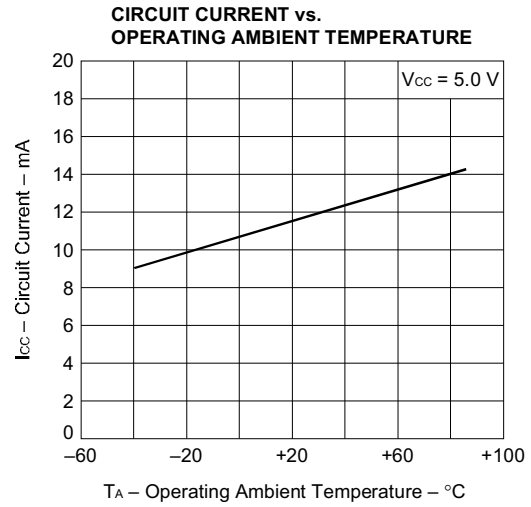
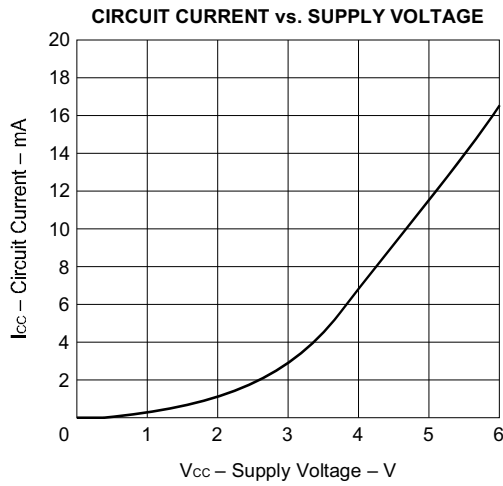

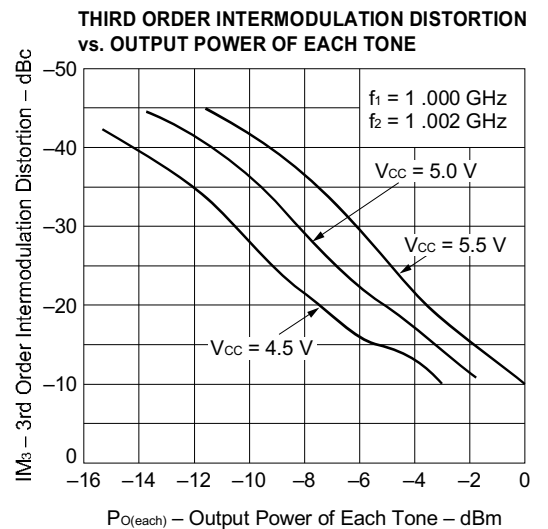
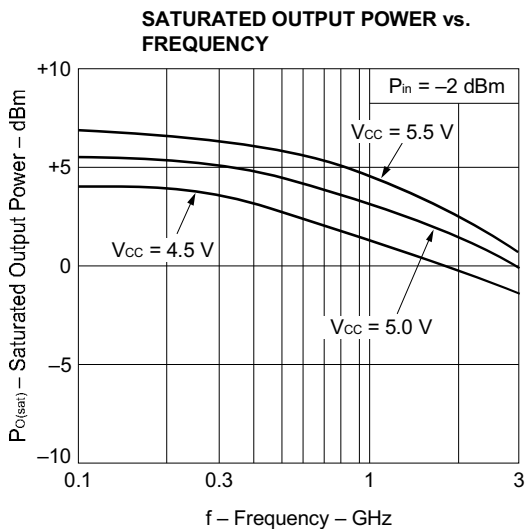
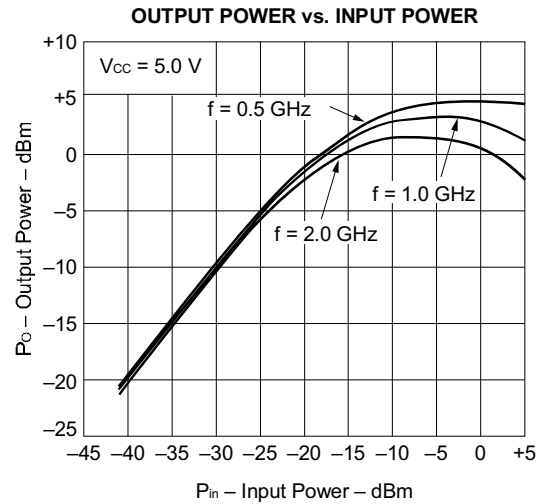
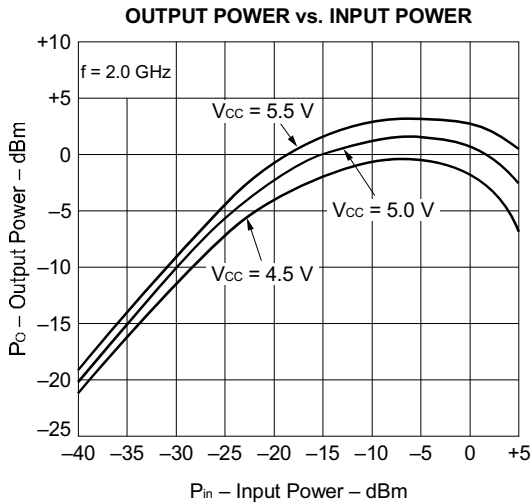
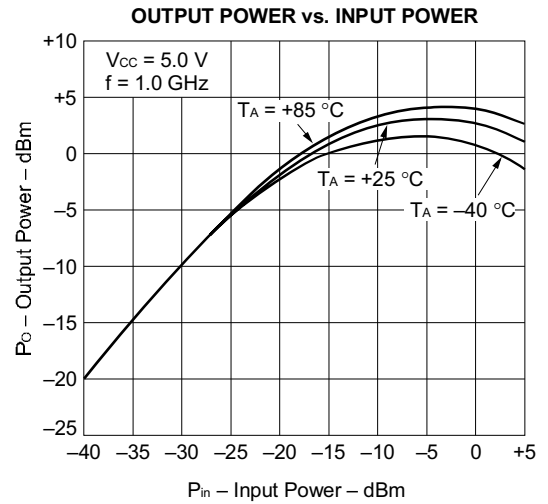
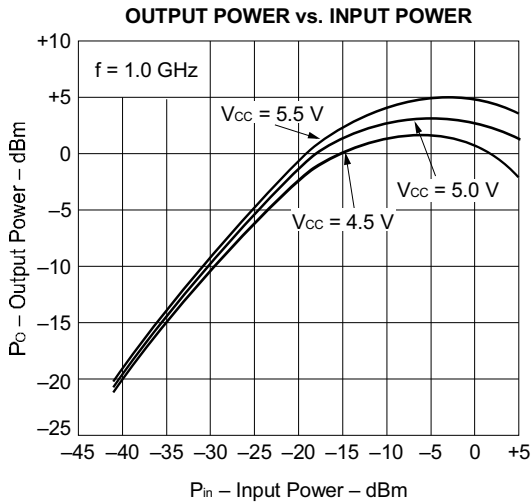

S-PARAMETER ( $V_{cc} = 5.0\text{ V}$ )

S<sub>11</sub>-FREQUENCY

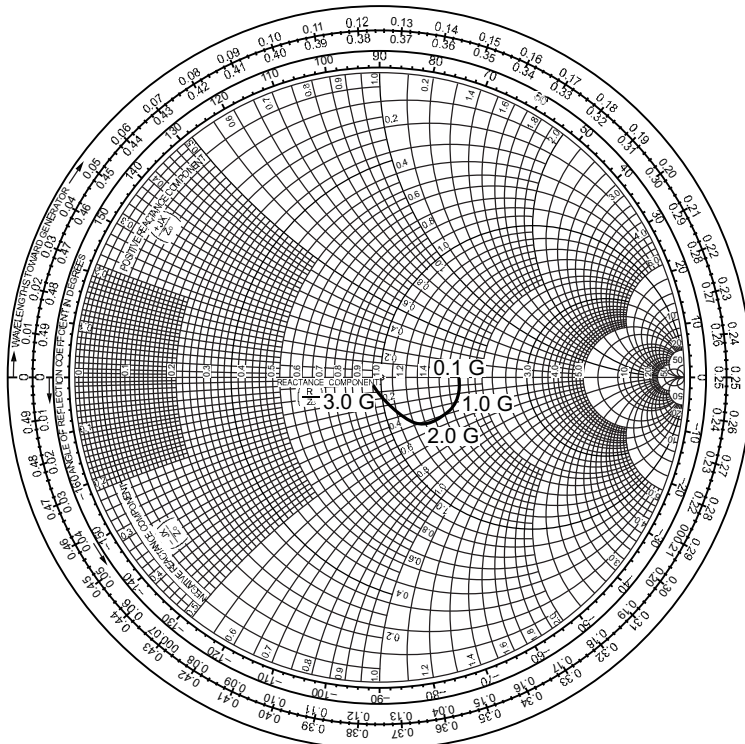

S<sub>22</sub>-FREQUENCY

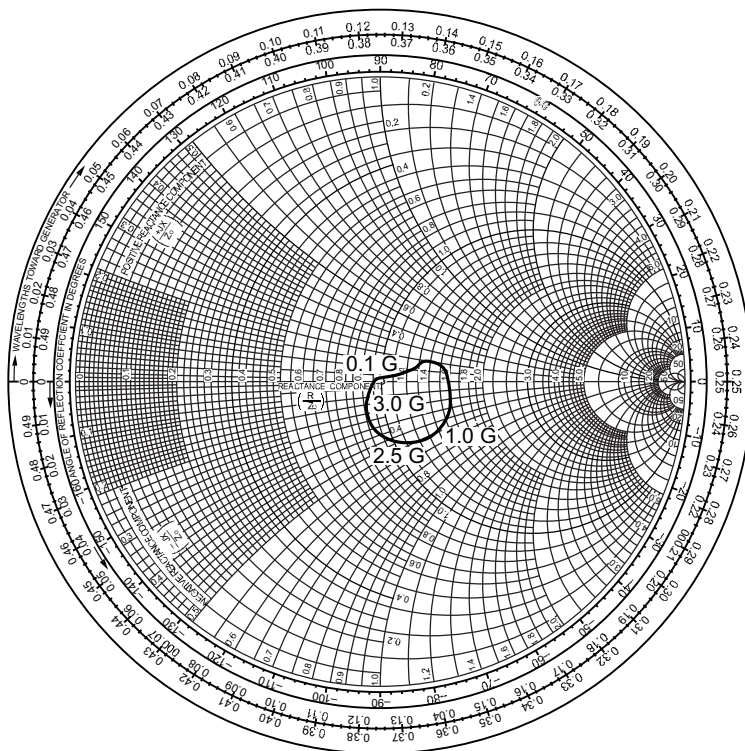
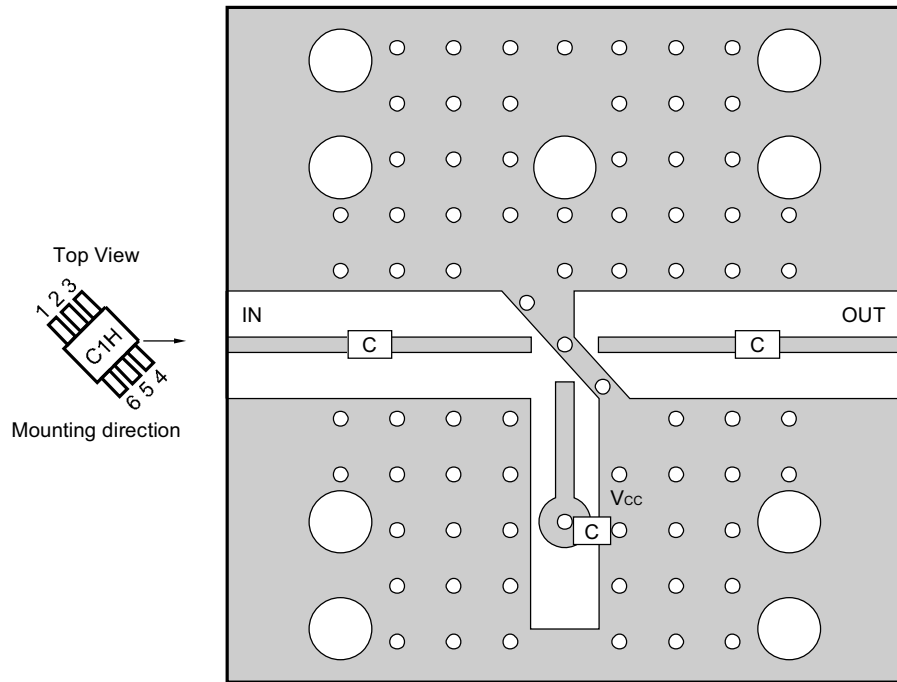

ILLUSTRATION OF APPLICATION CIRCUIT ASSEMBLED ON EVALUATION BOARD



COMPONENT LIST FOR APPLICATION EXAMPLE

	VALUE
C	1 000 pF

Note for evaluation board

1. 30 × 30 × 0.4 mm double copper clad polyimide board
2. Back side: GND pattern
3. Solder plated on pattern
4. ○○: Through holes

6 PIN MINI MOLD PACKAGE DIMENSIONS (Unit: mm)

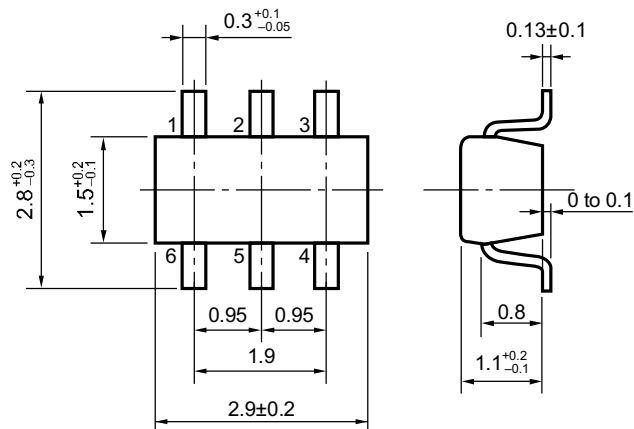



**NOTE ON CORRECT USE**

- (1) Observe precautions for handling because of electro-static sensitive devices.
- (2) Form a ground pattern as wide as possible to prevent an increase in ground impedance (to prevent undesired oscillation).
- (3) Keep the track length of the ground pins as short as possible.
- (4) Connect a bypass capacitor (e.g. 1000 pF) to the V<sub>CC</sub> pin.

**RECOMMENDED SOLDERING CONDITIONS**

This product should be soldered in the following recommended conditions. Other soldering methods and conditions than the recommended conditions are to be consulted with our sales representatives.

μPC2712T

Soldering method	Soldering conditions	Recommended condition symbols
Infrared ray reflow	Package peak temperature: 235 °C, Hour: within 30 s. (more than 210 °C), Time: 3 time, Limited days: no.*1	IR35-00-3
VPS	Package peak temperature: 215 °C, Hour: within 40 s. (more than 200 °C), Time: 3 time, Limited days: no.*1	VP15-00-3
Wave soldering	Soldering tub temperature: less than 260 °C, Hour: within 10 s. Time: 1 time, Limited days: no.	WS60-00-1
Pin part heating	Pin area temperature: less than 300 °C, Hour: within 3 s. Limited days: no.*1	

\*1 It is the storage days after opening a dry pack, the storage conditions are 25 °C, less than 65 % RH.

**Caution** The combined use of soldering method is to be avoided (However, except the pin area heating method).

For details of recommended soldering conditions for surface mounting, refer to information document SEMICONDUCTOR DEVICE MOUNTING TECHNOLOGY MANUAL (C10535E).

[MEMO]

[MEMO]

No part of this document may be copied or reproduced in any form or by any means without the prior written consent of NEC Corporation. NEC Corporation assumes no responsibility for any errors which may appear in this document.

NEC Corporation does not assume any liability for infringement of patents, copyrights or other intellectual property rights of third parties by or arising from use of a device described herein or any other liability arising from use of such device. No license, either express, implied or otherwise, is granted under any patents, copyrights or other intellectual property rights of NEC Corporation or others.

While NEC Corporation has been making continuous effort to enhance the reliability of its semiconductor devices, the possibility of defects cannot be eliminated entirely. To minimize risks of damage or injury to persons or property arising from a defect in an NEC semiconductor device, customers must incorporate sufficient safety measures in its design, such as redundancy, fire-containment, and anti-failure features.

NEC devices are classified into the following three quality grades:

"Standard", "Special", and "Specific". The Specific quality grade applies only to devices developed based on a customer designated "quality assurance program" for a specific application. The recommended applications of a device depend on its quality grade, as indicated below. Customers must check the quality grade of each device before using it in a particular application.

Standard: Computers, office equipment, communications equipment, test and measurement equipment, audio and visual equipment, home electronic appliances, machine tools, personal electronic equipment and industrial robots

Special: Transportation equipment (automobiles, trains, ships, etc.), traffic control systems, anti-disaster systems, anti-crime systems, safety equipment and medical equipment (not specifically designed for life support)

Specific: Aircrafts, aerospace equipment, submersible repeaters, nuclear reactor control systems, life support systems or medical equipment for life support, etc.

The quality grade of NEC devices is "Standard" unless otherwise specified in NEC's Data Sheets or Data Books. If customers intend to use NEC devices for applications other than those specified for Standard quality grade, they should contact an NEC sales representative in advance.

Anti-radioactive design is not implemented in this product.