

TLE207x-Q1, TLE207xA-Q1 EXCALIBUR LOW-NOISE HIGH-SPEED JFET-INPUT OPERATIONAL AMPLIFIERS

SGLS226B – DECEMBER 2003 – REVISED MAY 2008

- Qualified for Automotive Applications
- Direct Upgrades to TL05x, TL07x, and TL08x BiFET Operational Amplifiers
- Greater Than 2× Bandwidth (10 MHz) and 3× Slew Rate (45 V/μs) Than TL07x
- Ensured Maximum Noise Floor 17 nV/√Hz
- On-Chip Offset Voltage Trimming for Improved DC Performance
- Wider Supply Rails Increase Dynamic Signal Range to ±19 V

description/ordering information

The TLE207x series of JFET-input operational amplifiers more than double the bandwidth and triple the slew rate of the TL07x and TL08x families of BiFET operational amplifiers. Texas Instruments Excalibur process yields a typical noise floor of 11.6 nV/√Hz, 17-nV/√Hz ensured maximum, offering immediate improvement in noise-sensitive circuits designed using the TL07x. The TLE207x also has wider supply voltage rails, increasing the dynamic signal range for BiFET circuits to ±19 V. On-chip zener trimming of offset voltage yields precision grades for greater accuracy in dc-coupled applications. The TLE207x are pin-compatible with lower performance BiFET operational amplifiers for ease in improving performance in existing designs.

BiFET operational amplifiers offer the inherently higher input impedance of the JFET-input transistors, without sacrificing the output drive associated with bipolar amplifiers. This makes them better suited for interfacing with high-impedance sensors or very low-level ac signals. They also feature inherently better ac response than bipolar or CMOS devices having comparable power consumption.

The TLE207x family of BiFET amplifiers are Texas Instruments highest performance BiFETs, with tighter input offset voltage and ensured maximum noise specifications. Designers requiring less stringent specifications but seeking the improved ac characteristics of the TLE207x should consider the TLE208x operational amplifier family.

Because BiFET operational amplifiers are designed for use with dual power supplies, care must be taken to observe common-mode input voltage limits and output swing when operating from a single supply. DC biasing of the input signal is required and loads should be terminated to a virtual ground node at mid-supply. Texas Instruments TLE2426 integrated virtual ground generator is useful when operating BiFET amplifiers from single supplies.

ORDERING INFORMATION†

T _A	V _{IO} max AT 25°C	PACKAGE‡		ORDERABLE PART NUMBER	TOP-SIDE MARKING
-40°C to 125°C	2 mV	SOIC – D	Tape and reel	TLE2071AQDRQ1	2071AQ
	4 mV	SOIC – D	Tape and reel	TLE2071QDRQ1	2071Q1
	3.5 mV	SOIC – D	Tape and reel	TLE2072AQDRQ1	2072AQ
	6 mV	SOIC – D	Tape and reel	TLE2072QDRQ1	2072Q1
	4 mV	SOP – DW	Tape and reel	TLE2074AQDWRQ1§	TLE2074AQ1
	7 mV	SOP – DW	Tape and reel	TLE2074QDWRQ1§	TLE2074Q1

† For the most current package and ordering information, see the Package Option Addendum at the end of this document, or see the TI web site at <http://www.ti.com>.

‡ Package drawings, thermal data, and symbolization are available at <http://www.ti.com/packaging>.

§ Product Preview



Please be aware that an important notice concerning availability, standard warranty, and use in critical applications of Texas Instruments semiconductor products and disclaimers thereto appears at the end of this data sheet.

PRODUCTION DATA information is current as of publication date. Products conform to specifications per the terms of Texas Instruments standard warranty. Production processing does not necessarily include testing of all parameters.

 **TEXAS
INSTRUMENTS**

POST OFFICE BOX 655303 • DALLAS, TEXAS 75265

Copyright © 2008, Texas Instruments Incorporated

TLE207x-Q1, TLE207xA-Q1 EXCALIBUR LOW-NOISE HIGH-SPEED JFET-INPUT OPERATIONAL AMPLIFIERS

SGLS226B – DECEMBER 2003 – REVISED MAY 2008

description/ordering information (continued)

The TLE207x are fully specified at ± 15 V and ± 5 V. For operation in low-voltage and/or single-supply systems, Texas Instruments LinCMOS families of operational amplifiers (TLC- and TLV-prefix) are recommended. When moving from BiFET to CMOS amplifiers, particular attention should be paid to slew rate and bandwidth requirements and output loading.

**TLE2071 AND TLE2071A
D PACKAGE
(TOP VIEW)**

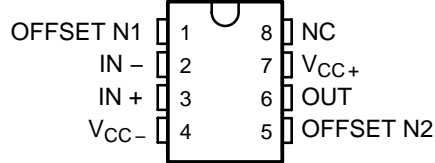

**TLE2072 AND TLE2072A
D PACKAGE
(TOP VIEW)**

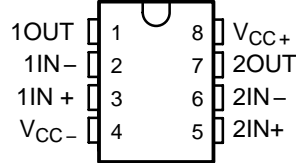

**TLE2074 AND TLE2074A
DW PACKAGE
(TOP VIEW)**

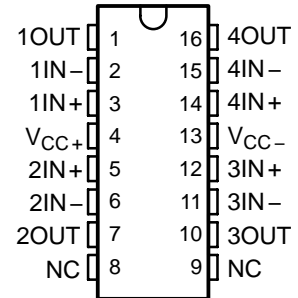

NC – No internal connection

symbol

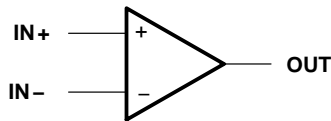

equivalent schematic

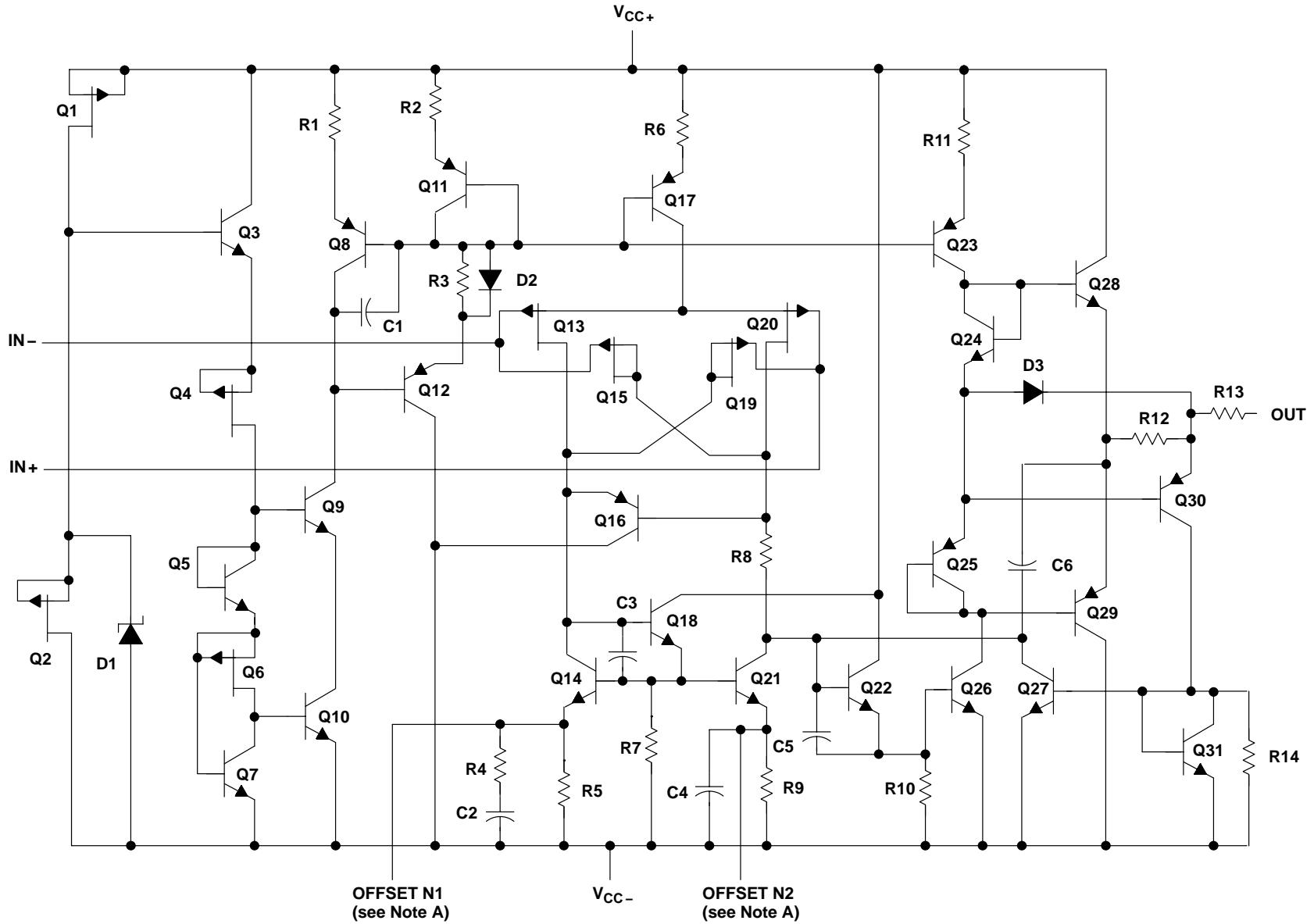

NOTES: A. OFFSET N1 AND OFFSET N2 are only available on the TLE2071x devices.

TLE207X-Q1, TLE207XA-Q1
EXCALIBUR LOW-NOISE HIGH-SPEED
JFET-INPUT OPERATIONAL AMPLIFIERS
SLOS181A – FEBRUARY 1997 – REVISED MARCH 2000 (sourced from)

equivalent schematic (continued)

ACTUAL DEVICE COMPONENT COUNT			
COMPONENT	TLE2071	TLE2072	TLE2074
Transistors	33	57	114
Resistors	25	37	74
Diodes	8	5	10
Capacitors	6	11	22

TLE207x-Q1, TLE207xA-Q1
EXCALIBUR LOW-NOISE HIGH-SPEED
JFET-INPUT OPERATIONAL AMPLIFIERS

SGLS226A – DECEMBER 2003 – REVISED AUGUST 2004

absolute maximum ratings over operating free-air temperature range (unless otherwise noted)†

Supply voltage, V_{CC+} (see Note 1)	19 V
Supply voltage, V_{CC-} (see Note 1)	–19 V
Differential input voltage range, V_{ID} (see Note 2)	V_{CC+} to V_{CC-}
Input voltage range, V_I (any input)	V_{CC+} to V_{CC-}
Input current, I_I (each input)	± 1 mA
Output current, I_O (each output)	± 80 mA
Total current into V_{CC+}	160 mA
Total current out of V_{CC-}	160 mA
Duration of short-circuit current at (or below) 25°C (see Note 3)	unlimited
Maximum Junction Temperature, T_J	150°C
Package thermal impedance, θ_{JA} (see Note 4): D package	126°C/W
DW package	75°C/W
Operating free-air temperature range, T_A : Q suffix	–40°C to 125°C
Storage temperature range	–65°C to 150°C
Lead temperature 1,6 mm (1/16 inch) from case for 3 seconds	300°C

† Stresses beyond those listed under “absolute maximum ratings” may cause permanent damage to the device. These are stress ratings only, and functional operation of the device at these or any other conditions beyond those indicated under “recommended operating conditions” is not implied. Exposure to absolute-maximum-rated conditions for extended periods may affect device reliability.

- NOTES:
1. All voltage values, except differential voltages, are with respect to the midpoint between V_{CC+} and V_{CC-} .
 2. Differential voltages are at the noninverting input with respect to the inverting input.
 3. The output may be shorted to either supply. Temperatures and/or supply voltages must be limited to ensure that the maximum dissipation rate is not exceeded.
 4. The package thermal impedance is calculated in accordance with JESD 51-7.

recommended operating conditions

		MIN	MAX	UNIT
Supply voltage, $V_{CC\pm}$		± 2.25	± 19	V
Common-mode input voltage, V_{IC}	$V_{CC\pm} = \pm 5$ V	–0.8	5	V
	$V_{CC\pm} = \pm 15$ V	–10.8	15	
Operating free-air temperature, T_A		–40	125	°C



TLE207x-Q1, TLE207xA-Q1 EXCALIBUR LOW-NOISE HIGH-SPEED JFET-INPUT OPERATIONAL AMPLIFIERS

SGLS226A – DECEMBER 2003 – REVISED AUGUST 2004

TLE2071-Q1 electrical characteristics at specified free-air temperature, $V_{CC\pm} = \pm 5$ V (unless otherwise noted)

PARAMETER	TEST CONDITIONS	T_A †	TLE2071-Q1			TLE2071A-Q1			UNIT	
			MIN	TYP	MAX	MIN	TYP	MAX		
V_{IO} Input offset voltage	$V_{IC} = 0,$ $R_S = 50 \Omega,$ $V_O = 0,$	25°C	0.34	4		0.3	2	mV		
		Full range			9		7			
α_{VIO} Temperature coefficient of input offset voltage		Full range	3.2			3.2 20			$\mu\text{V}/^\circ\text{C}$	
I_{IO} Input offset current	$V_{IC} = 0,$ $V_O = 0,$ See Figure 4	25°C	5	100		5	100	pA		
		Full range	20			20			nA	
I_{IB} Input bias current		25°C	15	175		15	175	pA		
		Full range	60			60			nA	
V_{ICR} Common-mode input voltage range	$R_S = 50 \Omega$	25°C	5 to -1	5 to -1.9		5 to -1	5 to -1.9	V		
		Full range	5 to -0.8			5 to -0.8				
V_{OM+} Maximum positive peak output voltage swing	$I_O = -200 \mu\text{A}$	25°C	3.8	4.1		3.8	4.1	V		
		Full range	3.6			3.6				
	$I_O = -2 \text{ mA}$	25°C	3.5	3.9		3.5	3.9			
		Full range	3.3			3.3				
	$I_O = -20 \text{ mA}$	25°C	1.5	2.3		1.5	2.3			
		Full range	1.4			1.4				
V_{OM-} Maximum negative peak output voltage swing	$I_O = 200 \mu\text{A}$	25°C	-3.8	-4.2		-3.8	-4.2	V		
		Full range	-3.6			-3.6				
	$I_O = 2 \text{ mA}$	25°C	-3.5	-4.1		-3.5	-4.1			
		Full range	-3.3			-3.3				
	$I_O = 20 \text{ mA}$	25°C	-1.5	-2.4		-1.5	-2.4			
		Full range	-1.4			-1.4				
A_{VD} Large-signal differential voltage amplification	$V_O = \pm 2.3 \text{ V}$	$R_L = 600 \Omega$	25°C	80	91		80	91	dB	
			Full range	78			78			
		$R_L = 2 \text{ k}\Omega$	25°C	90	100		90	100		
			Full range	88			88			
		$R_L = 10 \text{ k}\Omega$	25°C	95	106		95	106		
			Full range	93			93			
r_i Input resistance	$V_{IC} = 0$	25°C	10^{12}			10^{12}			Ω	
c_i Input capacitance	$V_{IC} = 0,$ See Figure 5	Common mode	25°C	11			11			pF
		Differential	25°C	2.5			2.5			
z_o Open-loop output impedance	$f = 1 \text{ MHz}$	25°C	80			80			Ω	
CMRR Common-mode rejection ratio	$V_{IC} = V_{ICRmin},$ $V_O = 0,$ $R_S = 50 \Omega$	25°C	70	89		70	89	dB		
		Full range	68			68				
k_{SVR} Supply-voltage rejection ratio ($\Delta V_{CC\pm} / \Delta V_{IO}$)	$V_{CC\pm} = \pm 5 \text{ V to } \pm 15 \text{ V},$ $V_O = 0,$ $R_S = 50 \Omega$	25°C	82	99		82	99	dB		
		Full range	80			80				

† Full range is -40°C to 125°C .



TLE207x-Q1, TLE207xA-Q1
EXCALIBUR LOW-NOISE HIGH-SPEED
JFET-INPUT OPERATIONAL AMPLIFIERS

SGLS226A – DECEMBER 2003 – REVISED AUGUST 2004

TLE2071-Q1 electrical characteristics at specified free-air temperature, $V_{CC\pm} = \pm 5\text{ V}$ (unless otherwise noted) (continued)

PARAMETER	TEST CONDITIONS	T_A †	TLE2071-Q1			TLE2071A-Q1			UNIT
			MIN	TYP	MAX	MIN	TYP	MAX	
I_{CC} Supply current	$V_O = 0$, No load	25°C	1.35	1.6	2.2	1.35	1.6	2.2	mA
		Full range	2.2			2.2			
I_{OS} Short-circuit output current	$V_O = 0$	25°C	$V_{ID} = 1\text{ V}$			-35			mA
			$V_{ID} = -1\text{ V}$			45			

† Full range is -40°C to 125°C .

TLE2071-Q1 operating characteristics at specified free-air temperature, $V_{CC\pm} = \pm 5\text{ V}$

PARAMETER	TEST CONDITIONS	T_A †	TLE2071-Q1			TLE2071A-Q1			UNIT	
			MIN	TYP	MAX	MIN	TYP	MAX		
SR+ Positive slew rate	$V_{O(PP)} = \pm 2.3\text{ V}$, $A_{VD} = -1$, $R_L = 2\text{ k}\Omega$, $C_L = 100\text{ pF}$, See Figure 1	25°C	35			35			V/ μs	
		Full range	20			20				
SR- Negative slew rate		25°C	38			38			V/ μs	
		Full range	20			20				
t_s Settling time	$A_{VD} = -1$, 2-V step, $R_L = 1\text{ k}\Omega$, $C_L = 100\text{ pF}$	25°C	To 10 mV			0.25			μs	
			To 1 mV			0.4				
V_n Equivalent input noise voltage	$R_S = 20\ \Omega$, See Figure 3	25°C	f = 10 Hz		28		55		nV/ $\sqrt{\text{Hz}}$	
			f = 10 kHz		11.6		17			
$V_{N(PP)}$ Peak-to-peak equivalent input noise voltage		25°C	f = 10 Hz to 10 kHz		6		6		μV	
			f = 0.1 Hz to 10 Hz		0.6		0.6			
I_n Equivalent input noise current	$V_{IC} = 0$, f = 10 kHz	25°C	2.8			2.8			fA/ $\sqrt{\text{Hz}}$	
THD + N Total harmonic distortion plus noise	$V_{O(PP)} = 5\text{ V}$, f = 1 kHz, $R_S = 25\ \Omega$	$A_{VD} = 10$, $R_L = 2\text{ k}\Omega$,	25°C	0.013%			0.013%			
B_1 Unity-gain bandwidth	$V_I = 10\text{ mV}$, $C_L = 25\text{ pF}$,	$R_L = 2\text{ k}\Omega$, See Figure 2	25°C	9.4			9.4			MHz
B_{OM} Maximum output-swing bandwidth	$V_{O(PP)} = 4\text{ V}$, $R_L = 2\text{ k}\Omega$,	$A_{VD} = -1$, $C_L = 25\text{ pF}$	25°C	2.8			2.8			MHz
ϕ_m Phase margin at unity gain	$V_I = 10\text{ mV}$, $C_L = 25\text{ pF}$,	$R_L = 2\text{ k}\Omega$, See Figure 2	25°C	56			56			

† Full range is -40°C to 125°C .

TLE207x-Q1, TLE207xA-Q1
EXCALIBUR LOW-NOISE HIGH-SPEED
JFET-INPUT OPERATIONAL AMPLIFIERS

SGLS226A – DECEMBER 2003 – REVISED AUGUST 2004

TLE2071-Q1 electrical characteristics at specified free-air temperature, $V_{CC\pm} = \pm 15$ V (unless otherwise noted)

PARAMETER	TEST CONDITIONS	T_A †	TLE2071-Q1			TLE2071A-Q1			UNIT
			MIN	TYP	MAX	MIN	TYP	MAX	
V_{IO} Input offset voltage	$V_{IC} = 0, V_O = 0, R_S = 50 \Omega$	25°C	0.49		4	0.47		2	mV
		Full range			9			7	
α_{VIO} Temperature coefficient of input offset voltage		Full range	3.2			3.2		20	$\mu V/^\circ C$
I_{IO} Input offset current	$V_{IC} = 0, V_O = 0, \text{See Figure 4}$	25°C	6	100		6	100		pA
		Full range			20			20	nA
I_{IB} Input bias current		25°C	20	175		20	175		pA
		Full range			60			60	nA
V_{ICR} Common-mode input voltage range	$R_S = 50 \Omega$	25°C	15 to -11	15 to -11.9		15 to -11	15 to -11.9		V
		Full range	15 to -10.9			15 to -10.9			
V_{OM+} Maximum positive peak output voltage swing	$I_O = -200 \mu A$	25°C	13.8	14.1		13.8	14.1		V
		Full range	13.6			13.6			
	$I_O = -2 \text{ mA}$	25°C	13.5	13.9		13.5	13.9		
		Full range	13.3			13.3			
	$I_O = -20 \text{ mA}$	25°C	11.5	12.3		11.5	12.3		
		Full range	11.4			11.4			
V_{OM-} Maximum negative peak output voltage swing	$I_O = 200 \mu A$	25°C	-13.8	-14.2		-13.8	-14.2		V
		Full range	-13.6			-13.6			
	$I_O = 2 \text{ mA}$	25°C	-13.5	-14		-13.5	-14		
		Full range	-13.3			-13.3			
	$I_O = 20 \text{ mA}$	25°C	-11.5	-12.4		-11.5	-12.4		
		Full range	-11.4			-11.4			
A_{VD} Large-signal differential voltage amplification	$V_O = \pm 10 \text{ V}$	$R_L = 600 \Omega$	25°C	80	96		80	96	dB
			Full range	78			78		
		$R_L = 2 \text{ k}\Omega$	25°C	90	109		90	109	
			Full range	88			88		
		$R_L = 10 \text{ k}\Omega$	25°C	95	118		95	118	
			Full range	93			93		
r_i Input resistance	$V_{IC} = 0$	25°C	10^{12}			10^{12}		Ω	
c_i Input capacitance	$V_{IC} = 0, \text{See Figure 5}$	Common mode	25°C	7.5			7.5		pF
		Differential	25°C	2.5			2.5		
z_o Open-loop output impedance	$f = 1 \text{ MHz}$	25°C	80			80		Ω	
CMRR Common-mode rejection ratio	$V_{IC} = V_{ICRmin}, V_O = 0, R_S = 50 \Omega$	25°C	80	98		80	98	dB	
		Full range	78			78			
k_{SVR} Supply-voltage rejection ratio ($\Delta V_{CC\pm} / \Delta V_{IO}$)	$V_{CC\pm} = \pm 5 \text{ V to } \pm 15 \text{ V}, V_O = 0, R_S = 50 \Omega$	25°C	82	99		82	99	dB	
		Full range	80			80			

† Full range is $-40^\circ C$ to $125^\circ C$.



TLE207x-Q1, TLE207xA-Q1
EXCALIBUR LOW-NOISE HIGH-SPEED
JFET-INPUT OPERATIONAL AMPLIFIERS

SGLS226A – DECEMBER 2003 – REVISED AUGUST 2004

TLE2071-Q1 electrical characteristics at specified free-air temperature, $V_{CC\pm} = \pm 15$ V (unless otherwise noted) (continued)

PARAMETER	TEST CONDITIONS	T_A †	TLE2071-Q1			TLE2071A-Q1			UNIT
			MIN	TYP	MAX	MIN	TYP	MAX	
I_{CC} Supply current	$V_O = 0$, No load	25°C	1.35	1.7	2.2	1.35	1.7	2.2	mA
		Full range	2.2			2.2			
I_{OS} Short-circuit output current	$V_O = 0$	25°C	$V_{ID} = 1$ V	-30	-45	-30	-45	mA	
			$V_{ID} = -1$ V	30	48	30	48		

† Full range is -40°C to 125°C .

TLE2071-Q1 operating characteristics at specified free-air temperature, $V_{CC\pm} = \pm 15$ V

PARAMETER	TEST CONDITIONS	T_A †	TLE2071-Q1			TLE2071A-Q1			UNIT
			MIN	TYP	MAX	MIN	TYP	MAX	
SR+ Positive slew rate	$V_{O(PP)} = 10$ V, $A_{VD} = -1$, $R_L = 2$ k Ω , See Figure 1	25°C	30	40		30	40	V/ μ s	
		Full range	22			22			
SR- Negative slew rate		25°C	30	45		30	45	V/ μ s	
		Full range	22			22			
t_s Settling time	$A_{VD} = -1$, 10-V step, $R_L = 1$ k Ω , $C_L = 100$ pF	25°C	To 10 mV	0.4		0.4		μ s	
			To 1 mV	1.5		1.5			
V_n Equivalent input noise voltage	$R_S = 20$ Ω , See Figure 3	25°C	f = 10 Hz	28	55	28	55	nV/ $\sqrt{\text{Hz}}$	
			f = 10 kHz	11.6	17	11.6	17		
$V_{N(PP)}$ Peak-to-peak equivalent input noise voltage		25°C	f = 10 Hz to 10 kHz	6		6		μ V	
			f = 0.1 Hz to 10 Hz	0.6		0.6			
I_n Equivalent input noise current	$V_{IC} = 0$, f = 10 kHz	25°C	2.8		2.8		fA/ $\sqrt{\text{Hz}}$		
THD + N Total harmonic distortion plus noise	$V_{O(PP)} = 20$ V, $A_{VD} = 10$, f = 1 kHz, $R_L = 2$ k Ω , $R_S = 25$ Ω	25°C	0.008%		0.008%				
B_1 Unity-gain bandwidth	$V_I = 10$ mV, $R_L = 2$ k Ω , $C_L = 25$ pF, See Figure 2	25°C	8	10	8	10	MHz		
B_{OM} Maximum output-swing bandwidth	$V_{O(PP)} = 20$ V, $A_{VD} = -1$, $R_L = 2$ k Ω , $C_L = 25$ pF	25°C	478	637	478	637	kHz		
ϕ_m Phase margin at unity gain	$V_I = 10$ mV, $R_L = 2$ k Ω , $C_L = 25$ pF, See Figure 2	25°C	57		57				

† Full range is -40°C to 125°C .



TLE207x-Q1, TLE207xA-Q1
EXCALIBUR LOW-NOISE HIGH-SPEED
JFET-INPUT OPERATIONAL AMPLIFIERS

SGLS226A – DECEMBER 2003 – REVISED AUGUST 2004

TLE2072-Q1 electrical characteristics at specified free-air temperature, $V_{CC\pm} = \pm 5$ V (unless otherwise noted)

PARAMETER	TEST CONDITIONS	T_A †	TLE2072-Q1			TLE2072A-Q1			UNIT	
			MIN	TYP	MAX	MIN	TYP	MAX		
V_{IO} Input offset voltage	$V_{IC} = 0, V_O = 0,$ $R_S = 50 \Omega,$	25°C	0.9	6		0.65	3.5	mV		
		Full range			10		8			
α_{VIO} Temperature coefficient of input offset voltage		Full range	2.3			2.3	20	$\mu V/^\circ C$		
I_{IO} Input offset current	$V_{IC} = 0, V_O = 0,$ See Figure 4	25°C	5	100		5	100	pA		
		Full range			20		20	nA		
I_{IB} Input bias current		25°C	15	175		15	175	pA		
		Full range			60		60	nA		
V_{ICR} Common-mode input voltage range	$R_S = 50 \Omega$	25°C	5 to -1	5 to -1.9		5 to -1	5 to -1.9	V		
		Full range	5 to -0.8			5 to -0.8				
V_{OM+} Maximum positive peak output voltage swing	$I_O = -200 \mu A$	25°C	3.8	4.1		3.8	4.1	V		
		Full range	3.6			3.6				
	$I_O = -2$ mA	25°C	3.5	3.9		3.5	3.9			
		Full range	3.3			3.3				
$I_O = -20$ mA	25°C	1.5	2.3		1.5	2.3				
	Full range	1.4			1.4					
V_{OM-} Maximum negative peak output voltage swing	$I_O = 200 \mu A$	25°C	-3.8	-4.2		-3.8	-4.2	V		
		Full range	-3.6			-3.6				
	$I_O = 2$ mA	25°C	-3.5	-4.1		-3.5	-4.1			
		Full range	-3.3			-3.3				
$I_O = 20$ mA	25°C	-1.5	-2.4		-1.5	-2.4				
	Full range	-1.4			-1.4					
A_{VD} Large-signal differential voltage amplification	$V_O = \pm 2.3$ V	$R_L = 600 \Omega$	25°C	80	91		80	91	dB	
			Full range	78			78			
		$R_L = 2$ k Ω	25°C	90	100		90	100		
			Full range	88			88			
		$R_L = 10$ k Ω	25°C	95	106		95	106		
			Full range	93			93			
r_i Input resistance	$V_{IC} = 0$	25°C	10^{12}			10^{12}			Ω	
C_i Input capacitance	$V_{IC} = 0,$ See Figure 5	Common mode	25°C	11			11			pF
		Differential	25°C	2.5			2.5			
z_o Open-loop output impedance	$f = 1$ MHz	25°C	80			80			Ω	
CMRR Common-mode rejection ratio	$V_{IC} = V_{ICRmin},$ $V_O = 0,$ $R_S = 50 \Omega$	25°C	70	89		70	89	dB		
		Full range	68			68				

† Full range is $-40^\circ C$ to $125^\circ C$.



TLE207x-Q1, TLE207xA-Q1
EXCALIBUR LOW-NOISE HIGH-SPEED
JFET-INPUT OPERATIONAL AMPLIFIERS

SGLS226A – DECEMBER 2003 – REVISED AUGUST 2004

TLE2072-Q1 electrical characteristics at specified free-air temperature, $V_{CC\pm} = \pm 5$ V (unless otherwise noted) (continued)

PARAMETER	TEST CONDITIONS	T_A^\dagger	TLE2072-Q1			TLE2072A-Q1			UNIT	
			MIN	TYP	MAX	MIN	TYP	MAX		
k_{SVR}	Supply-voltage rejection ratio ($\Delta V_{CC\pm} / \Delta V_{IO}$)	$V_{CC\pm} = \pm 5$ V to ± 15 V, $V_O = 0$, $R_S = 50 \Omega$	Full range			80			dB	
I_{CC}	Supply current (both channels)	$V_O = 0$, No load	25°C			2.7 2.9 3.6			mA	
			Full range			3.6				
a_x	Crosstalk attenuation	$V_{IC} = 0$, $R_L = 2$ k Ω	25°C			120			dB	
I_{OS}	Short-circuit output current	$V_O = 0$	25°C	$V_{ID} = 1$ V			-35			mA
				$V_{ID} = -1$ V			45			

† Full range is -40°C to 125°C .

TLE2072-Q1 operating characteristics at specified free-air temperature, $V_{CC\pm} = \pm 5$ V

PARAMETER	TEST CONDITIONS	T_A^\dagger	TLE2072-Q1			TLE2072A-Q1			UNIT
			MIN	TYP	MAX	MIN	TYP	MAX	
$SR+$	Positive slew rate	$V_{O(PP)} = \pm 2.3$ V, $A_{VD} = -1$, $R_L = 2$ k Ω , $C_L = 100$ pF, See Figure 1	25°C			35			V/ μ s
			Full range			18			
$SR-$	Negative slew rate	$V_{O(PP)} = \pm 2.3$ V, $A_{VD} = -1$, $R_L = 2$ k Ω , $C_L = 100$ pF, See Figure 1	25°C			38			V/ μ s
			Full range			18			
t_s	Settling time	$A_{VD} = -1$, 2-V step, $R_L = 1$ k Ω , $C_L = 100$ pF	To 10 mV			0.25			μ s
			To 1 mV			0.4			
V_n	Equivalent input noise voltage	$R_S = 20 \Omega$, See Figure 3	f = 10 Hz			28 55			nV/ $\sqrt{\text{Hz}}$
			f = 10 kHz			11.6 17			
$V_{N(PP)}$	Peak-to-peak equivalent input noise voltage	$R_S = 20 \Omega$, See Figure 3	f = 10 Hz to 10 kHz			6			μ V
			f = 0.1 Hz to 10 Hz			0.6			
I_n	Equivalent input noise current	$V_{IC} = 0$, f = 10 kHz	25°C			2.8			fA/ $\sqrt{\text{Hz}}$
THD + N	Total harmonic distortion plus noise	$V_{O(PP)} = 5$ V, f = 1 kHz, $R_S = 25 \Omega$	25°C			0.013%			
B_1	Unity-gain bandwidth	$V_I = 10$ mV, $C_L = 25$ pF, $R_L = 2$ k Ω , See Figure 2	25°C			9.4			MHz
B_{OM}	Maximum output-swing bandwidth	$V_{O(PP)} = 4$ V, $R_L = 2$ k Ω , $A_{VD} = -1$, $C_L = 25$ pF	25°C			2.8			MHz
ϕ_m	Phase margin at unity gain	$V_I = 10$ mV, $R_L = 2$ k Ω , $C_L = 25$ pF, See Figure 2	25°C			56			

† Full range is -40°C to 125°C .



TLE207x-Q1, TLE207xA-Q1 EXCALIBUR LOW-NOISE HIGH-SPEED JFET-INPUT OPERATIONAL AMPLIFIERS

SGLS226A – DECEMBER 2003 – REVISED AUGUST 2004

TLE2072-Q1 electrical characteristics at specified free-air temperature, $V_{CC\pm} = \pm 15$ V (unless otherwise noted)

PARAMETER	TEST CONDITIONS	T_A †	TLE2072-Q1			TLE2072A-Q1			UNIT	
			MIN	TYP	MAX	MIN	TYP	MAX		
V_{IO} Input offset voltage	$V_{IC} = 0, R_S = 50 \Omega, V_O = 0,$	25°C	1.1	6		0.7	3.5	mV		
		Full range			10		8			
α_{VIO} Temperature coefficient of input offset voltage		Full range	2.4			2.4	20	$\mu V/^\circ C$		
I_{IO} Input offset current	$V_{IC} = 0, V_O = 0,$ See Figure 4	25°C	6	100		6	100	pA		
		Full range			20		20	nA		
I_{IB} Input bias current		25°C	20	175		20	175	pA		
		Full range			60		60	nA		
V_{ICR} Common-mode input voltage range	$R_S = 50 \Omega$	25°C	15 to -11	15 to -11.9		15 to -11	15 to -11.9	V		
		Full range	15 to -10.8			15 to -10.8				
V_{OM+} Maximum positive peak output voltage swing	$I_O = -200 \mu A$	25°C	13.8	14.1		13.8	14.1	V		
		Full range	13.6			13.6				
	$I_O = -2$ mA	25°C	13.5	13.9		13.5	13.9			
		Full range	13.3			13.3				
	$I_O = -20$ mA	25°C	11.5	12.3		11.5	12.3			
		Full range	11.4			11.4				
V_{OM-} Maximum negative peak output voltage swing	$I_O = 200 \mu A$	25°C	-13.8	-14.2		-13.8	-14.2	V		
		Full range	-13.6			-13.6				
	$I_O = 2$ mA	25°C	-13.5	-14		-13.5	-14			
		Full range	-13.3			-13.3				
	$I_O = 20$ mA	25°C	-11.5	-12.4		-11.5	-12.4			
		Full range	-11.4			-11.4				
A_{VD} Large-signal differential voltage amplification	$V_O = \pm 10$ V	$R_L = 600 \Omega$	25°C	80	96		80	96	dB	
			Full range	78			78			
		$R_L = 2$ k Ω	25°C	90	109		90	109		
			Full range	89			89			
		$R_L = 10$ k Ω	25°C	95	118		95	118		
			Full range	93			93			
r_i Input resistance	$V_{IC} = 0$	25°C	10^{12}			10^{12}			Ω	
C_i Input capacitance	$V_{IC} = 0,$ See Figure 5	Common mode	25°C	7.5			7.5			pF
		Differential	25°C	2.5			2.5			
z_o Open-loop output impedance	$f = 1$ MHz	25°C	80			80			Ω	
CMRR Common-mode rejection ratio	$V_{IC} = V_{ICRmin}, V_O = 0, R_S = 50 \Omega$	25°C	80	98		80	98	dB		
		Full range	78			78				
k_{SVR} Supply-voltage rejection ratio ($\Delta V_{CC\pm}/\Delta V_{IO}$)	$V_{CC\pm} = \pm 5$ V to ± 15 V, $V_O = 0, R_S = 50 \Omega$	25°C	82	99		82	99	dB		
		Full range	80			80				

† Full range is $-40^\circ C$ to $125^\circ C$.



TLE207x-Q1, TLE207xA-Q1
EXCALIBUR LOW-NOISE HIGH-SPEED
JFET-INPUT OPERATIONAL AMPLIFIERS

SGLS226A – DECEMBER 2003 – REVISED AUGUST 2004

TLE2072-Q1 electrical characteristics at specified free-air temperature, $V_{CC\pm} = \pm 15$ V (unless otherwise noted) (continued)

PARAMETER	TEST CONDITIONS	T_A †	TLE2072-Q1			TLE2072A-Q1			UNIT	
			MIN	TYP	MAX	MIN	TYP	MAX		
I_{CC}	Supply current (both channels)	$V_O = 0$, No load	25°C	2.7	3.1	3.6	2.7	3.1	3.6	mA
			Full range	3.6			3.6			
a_x	Crosstalk attenuation	$V_{IC} = 0$, $R_L = 2$ k Ω	25°C	120			120			dB
I_{OS}	Short-circuit output current	$V_O = 0$	25°C	$V_{ID} = 1$ V	-30	-45	-30	-45	mA	
				$V_{ID} = -1$ V	30	48	30	48		

† Full range is -40°C to 125°C.

TLE2072-Q1 operating characteristics at specified free-air temperature, $V_{CC\pm} = \pm 15$ V

PARAMETER	TEST CONDITIONS	T_A †	TLE2072-Q1			TLE2072A-Q1			UNIT
			MIN	TYP	MAX	MIN	TYP	MAX	
SR +	Positive slew rate	$V_{O(PP)} = 10$ V, $R_L = 2$ k Ω , $C_L = 100$ pF, See Figure 1	25°C	28	40		28	40	V/ μ s
			Full range	20			20		
SR -	Negative slew rate	$V_{O(PP)} = 10$ V, $R_L = 2$ k Ω , $C_L = 100$ pF, See Figure 1	25°C	30	45		30	45	V/ μ s
			Full range	20			20		
t_s	Settling time	$A_{VD} = -1$, 10-V step, $R_L = 1$ k Ω , $C_L = 100$ pF	25°C	To 10 mV	0.4		0.4		μ s
				To 1 mV	1.5		1.5		
V_n	Equivalent input noise voltage	$R_S = 20$ Ω , See Figure 3	25°C	f = 10 Hz	28	55	28	55	nV/ \sqrt{Hz}
				f = 10 kHz	11.6	17	11.6	17	
$V_{N(PP)}$	Peak-to-peak equivalent input noise voltage	$R_S = 20$ Ω , See Figure 3	25°C	f = 10 Hz to 10 kHz	6		6		μ V
				f = 0.1 Hz to 10 Hz	0.6		0.6		
I_n	Equivalent input noise current	$V_{IC} = 0$, f = 10 kHz	25°C	2.8		2.8		fA/ \sqrt{Hz}	
THD + N	Total harmonic distortion plus noise	$V_{O(PP)} = 20$ V, f = 1 kHz, $R_S = 25$ Ω , $A_{VD} = 10$, $R_L = 2$ k Ω	25°C	0.008%		0.008%			
B_1	Unity-gain bandwidth	$V_I = 10$ mV, $R_L = 2$ k Ω , $C_L = 25$ pF, See Figure 2	25°C	8	10	8	10	MHz	
B_{OM}	Maximum output-swing bandwidth	$V_{O(PP)} = 20$ V, $R_L = 2$ k Ω , $A_{VD} = -1$, $C_L = 25$ pF	25°C	478	637	478	637	kHz	
ϕ_m	Phase margin at unity gain	$V_I = 10$ mV, $R_L = 2$ k Ω , $C_L = 25$ pF, See Figure 2	25°C	57		57			

† Full range is -40°C to 125°C.



TLE207x-Q1, TLE207xA-Q1
EXCALIBUR LOW-NOISE HIGH-SPEED
JFET-INPUT OPERATIONAL AMPLIFIERS

SGLS226A – DECEMBER 2003 – REVISED AUGUST 2004

TLE2074-Q1 electrical characteristics at specified free-air temperature, $V_{CC\pm} = \pm 5$ V (unless otherwise noted)

PARAMETER	TEST CONDITIONS	T_A †	TLE2074-Q1			TLE2074A-Q1			UNIT	
			MIN	TYP	MAX	MIN	TYP	MAX		
V_{IO} Input offset voltage	$V_{IC} = 0, V_O = 0, R_S = 50\Omega$	25°C	-1.6	7		-0.5	4	mV		
		Full range			11		9			
α_{VIO} Temperature coefficient of input offset voltage		Full range	10.1			10.1 30			$\mu V/^\circ C$	
I_{IO} Input offset current	$V_{IC} = 0, V_O = 0, \text{See Figure 4}$	25°C	15 100			15 100			pA	
		Full range				20			nA	
I_{IB} Input bias current		25°C	20 175			20 175			pA	
		Full range				60			nA	
V_{ICR} Common-mode input voltage range	$R_S = 50\Omega$	25°C	5 to -1	5 to -1.9		5 to -1	5 to -1.9	V		
		Full range	5 to -0.8			5 to -0.8				
V_{OM+} Maximum positive peak output voltage swing	$I_O = -200\mu A$	25°C	3.8 4.1			3.8 4.1		V		
		Full range	3.6			3.6				
	$I_O = -2\text{ mA}$	25°C	3.5 3.9			3.5 3.9				
		Full range	3.3			3.3				
	$I_O = -20\text{ mA}$	25°C	1.5 2.3			1.5 2.3				
		Full range	1.4			1.4				
V_{OM-} Maximum negative peak output voltage swing	$I_O = 200\mu A$	25°C	-3.8 -4.2			-3.8 -4.2		V		
		Full range	-3.6			-3.6				
	$I_O = 2\text{ mA}$	25°C	-3.5 -4.1			-3.5 -4.1				
		Full range	-3.3			-3.3				
	$I_O = 20\text{ mA}$	25°C	-1.5 -2.4			-1.5 -2.4				
		Full range	-1.4			-1.4				
A_{VD} Large-signal differential voltage amplification	$V_O = \pm 2.3\text{ V}$	$R_L = 600\Omega$	25°C	80 91			80 91		dB	
			Full range	78			78			
		$R_L = 2\text{ k}\Omega$	25°C	90 100			90 100			
			Full range	88			88			
		$R_L = 10\text{ k}\Omega$	25°C	95 106			95 106			
			Full range	93			93			
r_i Input resistance	$V_{IC} = 0$	25°C	10^{12}			10^{12}			Ω	
c_i Input capacitance	Common mode	$V_{IC} = 0, \text{See Figure 5}$	25°C	11			11			pF
	Differential		25°C	2.5			2.5			
z_o Open-loop output impedance	$f = 1\text{ MHz}$	25°C	80			80			Ω	
CMRR Common-mode rejection ratio	$V_{IC} = V_{ICRmin}, V_O = 0, R_S = 50\Omega$	25°C	70 89			70 89			dB	
		Full range	68			68				
k_{SVR} Supply-voltage rejection ratio ($\Delta V_{CC\pm} / \Delta V_{IO}$)	$V_{CC\pm} = \pm 5\text{ V to } \pm 15\text{ V}, V_O = 0, R_S = 50\Omega$	25°C	82 99			82 99			dB	
		Full range	80			80				

† Full range is -40°C to 125°C.



TLE207x-Q1, TLE207xA-Q1
EXCALIBUR LOW-NOISE HIGH-SPEED
JFET-INPUT OPERATIONAL AMPLIFIERS

SGLS226A – DECEMBER 2003 – REVISED AUGUST 2004

TLE2074-Q1 electrical characteristics at specified free-air temperature, $V_{CC\pm} = \pm 5\text{ V}$ (unless otherwise noted) (continued)

PARAMETER	TEST CONDITIONS	T_A^\dagger	TLE2074-Q1			TLE2074A-Q1			UNIT
			MIN	TYP	MAX	MIN	TYP	MAX	
I_{CC} Supply current (four amplifiers)	$V_O = 0$, No load	25°C	5.2	6.3	7.5	5.2	6.3	7.5	mA
		Full range	7.5			7.5			
Crosstalk attenuation	$V_{IC} = 0$, $R_L = 2\text{ k}\Omega$	25°C	120			120			dB
I_{OS} Short-circuit output current	$V_O = 0$	25°C	$V_{ID} = 1\text{ V}$			-35			mA
			$V_{ID} = -1\text{ V}$			45			

† Full range is -40°C to 125°C .

TLE2074-Q1 operating characteristics at specified free-air temperature, $V_{CC\pm} = \pm 5\text{ V}$

PARAMETER	TEST CONDITIONS	T_A^\dagger	TLE2074-Q1			TLE2074A-Q1			UNIT	
			MIN	TYP	MAX	MIN	TYP	MAX		
SR+ Positive slew rate	$V_{O(PP)} = \pm 2.3\text{ V}$, $A_{VD} = -1$, $C_L = 100\text{ pF}$, $R_L = 2\text{ k}\Omega$, See Figure 1	25°C	35			35			V/ μs	
		Full range	18			18				
SR- Negative slew rate		25°C	38			38			V/ μs	
		Full range	18			18				
t_s Settling time	$A_{VD} = -1$, 2-V step, $R_L = 1\text{ k}\Omega$, $C_L = 100\text{ pF}$	25°C	To 10 mV			0.25			μs	
			To 1 mV			0.4				
V_n Equivalent input noise voltage	$R_S = 20\ \Omega$, See Figure 3	25°C	f = 10 Hz		28		55		nV/ $\sqrt{\text{Hz}}$	
			f = 10 kHz		11.6		17			
$V_{N(PP)}$ Peak-to-peak equivalent input noise voltage		f = 10 Hz to 10 kHz	25°C	6			6			μV
				f = 0.1 Hz to 10 Hz			0.6			
I_n Equivalent input noise current	$V_{IC} = 0$, f = 10 kHz	25°C	2.8			2.8			fA/ $\sqrt{\text{Hz}}$	
THD + N Total harmonic distortion plus noise	$V_{O(PP)} = 5\text{ V}$, f = 1 kHz, $R_S = 25\ \Omega$	$A_{VD} = 10$, $R_L = 2\text{ k}\Omega$	25°C	0.013%			0.013%			
B_1 Unity-gain bandwidth	$V_I = 10\text{ mV}$, $C_L = 25\text{ pF}$	$R_L = 2\text{ k}\Omega$, See Figure 2	25°C	9.4			9.4			MHz
B_{OM} Maximum output-swing bandwidth	$V_{O(PP)} = 4\text{ V}$, $R_L = 2\text{ k}\Omega$	$A_{VD} = -1$, $C_L = 25\text{ pF}$	25°C	2.8			2.8			MHz
f_m Phase margin at unity gain	$V_I = 10\text{ mV}$, $C_L = 25\text{ pF}$	$R_L = 2\text{ k}\Omega$, See Figure 2	25°C	56			56			

† Full range is -40°C to 125°C .

TLE207x-Q1, TLE207xA-Q1
EXCALIBUR LOW-NOISE HIGH-SPEED
JFET-INPUT OPERATIONAL AMPLIFIERS

SGLS226A – DECEMBER 2003 – REVISED AUGUST 2004

TLE2074-Q1 electrical characteristics at specified free-air temperature, $V_{CC\pm} = \pm 15$ V (unless otherwise noted)

PARAMETER	TEST CONDITIONS	T_A^\dagger	TLE2074-Q1			TLE2074A-Q1			UNIT
			MIN	TYP	MAX	MIN	TYP	MAX	
V_{IO} Input offset voltage	$V_{IC} = 0, V_O = 0, R_S = 50 \Omega$	25°C	-1.6	7		-0.5	4	mV	
		Full range			11		9		
α_{VIO} Temperature coefficient of input offset voltage		Full range	10.1			10.1 30		$\mu V/^\circ C$	
I_{IO} Input offset current	$V_{IC} = 0, V_O = 0, \text{See Figure 4}$	25°C	15	100		15	100	pA	
		Full range		20		20		nA	
I_{IB} Input bias current		25°C	25	175		25	175	pA	
		Full range		60		60		nA	
V_{ICR} Common-mode input voltage range	$R_S = 50 \Omega$	25°C	15 to -11	15 to -11.9		15 to -11	15 to -11.9	V	
		Full range	15 to -10.8			15 to -10.8			
V_{OM+} Maximum positive peak output voltage swing	$I_O = -200 \mu A$	25°C	13.8	14.1		13.8	14.1	V	
		Full range	13.6			13.6			
	$I_O = -2 \text{ mA}$	25°C	13.5	13.9		13.5	13.9		
		Full range	13.3			13.3			
	$I_O = -20 \text{ mA}$	25°C	11.5	12.3		11.5	12.3		
		Full range	11.4			11.4			
V_{OM-} Maximum negative peak output voltage swing	$I_O = 200 \mu A$	25°C	-13.8	-14.2		-13.8	-14.2	V	
		Full range	-13.6			-13.6			
	$I_O = 2 \text{ mA}$	25°C	-13.5	-14		-13.5	-14		
		Full range	-13.3			-13.3			
	$I_O = 20 \text{ mA}$	25°C	-11.5	-12.4		-11.5	-12.4		
		Full range	-11.4			-11.4			
A_{VD} Large-signal differential voltage amplification	$V_O = \pm 10 \text{ V}$	$R_L = 600 \Omega$	25°C	80	96		80	96	dB
			Full range	78			78		
		$R_L = 2 \text{ k}\Omega$	25°C	90	109		90	109	
			Full range	88			88		
		$R_L = 10 \text{ k}\Omega$	25°C	95	118		95	118	
			Full range	93			93		
r_i Input resistance	$V_{IC} = 0$	25°C	10^{12}			10^{12}		Ω	
C_i Input capacitance	Common mode	$V_{IC} = 0, \text{See Figure 5}$	25°C	7.5			7.5		pF
	Differential		25°C	2.5			2.5		
z_o Open-loop output impedance	$f = 1 \text{ MHz}$	25°C	80			80		Ω	
CMRR Common-mode rejection ratio	$V_{IC} = V_{ICRmin}, V_O = 0, R_S = 50 \Omega$	25°C	80	98		80	98	dB	
		Full range	78			78			
k_{SVR} Supply-voltage rejection ratio ($\Delta V_{CC\pm} / \Delta V_{IO}$)	$V_{CC\pm} = \pm 5 \text{ V to } \pm 15 \text{ V}, V_O = 0, R_S = 50 \Omega$	25°C	82	99		82	99	dB	
		Full range	80			80			

† Full range is $-40^\circ C$ to $125^\circ C$.



TLE207x-Q1, TLE207xA-Q1
EXCALIBUR LOW-NOISE HIGH-SPEED
JFET-INPUT OPERATIONAL AMPLIFIERS

SGLS226A – DECEMBER 2003 – REVISED AUGUST 2004

TLE2074-Q1 electrical characteristics at specified free-air temperature, $V_{CC\pm} = \pm 15$ V (unless otherwise noted) (continued)

PARAMETER	TEST CONDITIONS	T_A^\dagger	TLE2074-Q1			TLE2074A-Q1			UNIT	
			MIN	TYP	MAX	MIN	TYP	MAX		
I_{CC}	Supply current (four amplifiers)	$V_O = 0$, No load	25°C	5.2	6.5	7.5	5.2	6.5	7.5	mA
			Full range	7.5			7.5			
	Crosstalk attenuation	$V_{IC} = 0$, $R_L = 2$ k Ω	25°C	120			120			dB
I_{OS}	Short-circuit output current	$V_O = 0$	25°C	$V_{ID} = 1$ V	-30	-45	-30	-45	mA	
				$V_{ID} = -1$ V	30	48	30	48		

† Full range is -40°C to 125°C.

TLE2074-Q1 operating characteristics at specified free-air temperature, $V_{CC\pm} = \pm 15$ V

PARAMETER	TEST CONDITIONS	T_A^\dagger	TLE2074-Q1			TLE2074A-Q1			UNIT
			MIN	TYP	MAX	MIN	TYP	MAX	
SR +	Positive slew rate	$V_{O(PP)} = 10$ V, $R_L = 2$ k Ω , See Figure 1	25°C	25	40	25	40	V/ μ s	
			Full range	17			17		
SR -	Negative slew rate	See Figure 1	25°C	30	45	30	45	V/ μ s	
			Full range	20			20		
t_s	Settling time	$A_{VD} = -1$, 10-V step, $R_L = 1$ k Ω , $C_L = 100$ pF	25°C	To 10 mV	0.4		0.4		μ s
				To 1 mV	1.5		1.5		
V_n	Equivalent input noise voltage	$R_S = 20$ Ω , See Figure 3	25°C	f = 10 Hz	28	55	28	55	nV/ \sqrt{Hz}
				f = 10 kHz	11.6	17	11.6	17	
$V_{N(PP)}$	Peak-to-peak equivalent input noise voltage	See Figure 3	25°C	f = 10 Hz to 10 kHz	6		6		μ V
				f = 0.1 Hz to 10 Hz	0.6		0.6		
I_n	Equivalent input noise current	$V_{IC} = 0$, f = 10 kHz	25°C	2.8		2.8		fA/ \sqrt{Hz}	
THD + N	Total harmonic distortion plus noise	$V_{O(PP)} = 20$ V, f = 1 kHz, $R_S = 25$ Ω	25°C	0.008%		0.008%			
B_1	Unity-gain bandwidth	$V_I = 10$ mV, $C_L = 25$ pF, $R_L = 2$ k Ω , See Figure 2	25°C	8	10	8	10	MHz	
B_{OM}	Maximum output-swing bandwidth	$V_{O(PP)} = 20$ V, $R_L = 2$ k Ω , $A_{VD} = -1$, $C_L = 25$ pF	25°C	478	637	478	637	kHz	
ϕ_m	Phase margin at unity gain	$V_I = 10$ mV, $C_L = 25$ pF, $R_L = 2$ k Ω , See Figure 2	25°C	57		57			

† Full range is -40°C to 125°C.



TLE207x-Q1, TLE207xA-Q1 EXCALIBUR LOW-NOISE HIGH-SPEED JFET-INPUT OPERATIONAL AMPLIFIERS

SGLS226A – DECEMBER 2003 – REVISED AUGUST 2004

PARAMETER MEASUREMENT INFORMATION

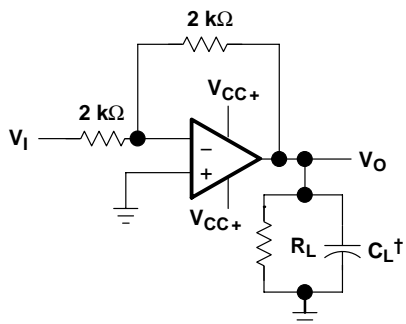

† Includes fixture capacitance

Figure 1. Slew-Rate Test Circuit

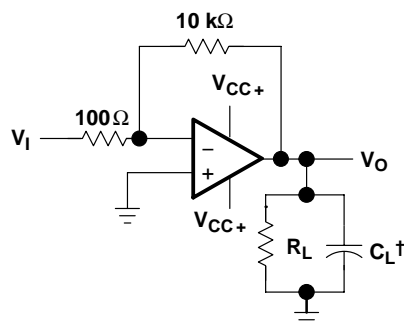

† Includes fixture capacitance

Figure 2. Unity-Gain Bandwidth and Phase-Margin Test Circuit

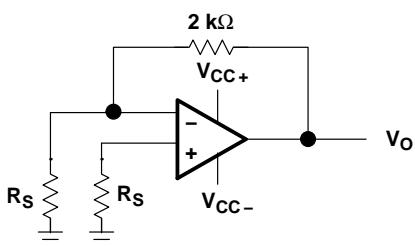

Figure 3. Noise-Voltage Test Circuit

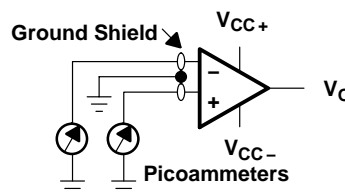

Figure 4. Input-Bias and Offset-Current Test Circuit

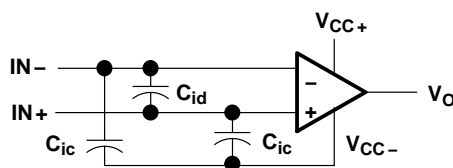

Figure 5. Internal Input Capacitance

typical values

Typical values presented in this data sheet represent the median (50% point) of device parametric performance.

input bias and offset current

At the picoampere bias current level typical of the TLE207x and TLE207xA, accurate measurement of the bias current becomes difficult. Not only does this measurement require a picoammeter but test socket leakages can easily exceed the actual device bias currents. To accurately measure these small currents, Texas Instruments uses a two-step process. The socket leakage is measured using picoammeters with bias voltages applied but with no device in the socket. The device is then inserted in the socket and a second test is performed that measures both the socket leakage and the device input bias current. The two measurements are then subtracted algebraically to determine the bias current of the device.

TYPICAL CHARACTERISTICS

Table of Graphs

		FIGURE
V_{IO}	Input offset voltage	Distribution 6, 7, 8
α_{VIO}	Temperature coefficient of input offset voltage	Distribution 9, 10, 11
I_{IO}	Input offset current	vs Free-air temperature 12, 13
I_{IB}	Input bias current	vs Free-air temperature vs Total supply voltage 12, 13 14
V_{ICR}	Common-mode input voltage range	vs Free-air temperature 15
V_O	Output voltage	vs Differential input voltage 16, 17
V_{OM+}	Maximum positive peak output voltage	vs Output current 18
V_{OM-}	Maximum negative peak output voltage	vs Output current 19
V_{OM}	Maximum peak output voltage	vs Free-air temperature vs Supply voltage 20, 21 22
$V_{O(PP)}$	Maximum peak-to-peak output voltage	vs Frequency 23
V_O	Output voltage	vs Settling time 24
A_{VD}	Large-signal differential voltage amplification	vs Load resistance vs Free-air temperature 25 26, 27
A_{VD}	Small-signal differential voltage amplification	vs Frequency 28, 29
CMRR	Common-mode rejection ratio	vs Frequency vs Free-air temperature 30 31
k_{SVR}	Supply-voltage rejection ratio	vs Frequency vs Free-air temperature 32 33
I_{CC}	Supply current	vs Supply voltage vs Free-air temperature vs Differential input voltage 34, 35, 36 37, 38, 39 40 – 45
I_{OS}	Short-circuit output current	vs Supply voltage vs Elapsed time vs Free-air temperature 46 47 48
SR	Slew rate	vs Free-air temperature vs Load resistance vs Differential input voltage 49, 50 51 52
V_n	Equivalent Input noise voltage (spectral density)	vs Frequency 53
V_n	Input referred noise voltage	vs Noise bandwidth Over a 10-second time interval 54 55
	Third-octave spectral noise density	vs Frequency bands 56
THD + N	Total harmonic distortion plus noise	vs Frequency 57, 58
B_1	Unity-gain bandwidth	vs Load capacitance 59
	Gain-bandwidth product	vs Free-air temperature vs Supply voltage 60 61
	Gain margin	vs Load capacitance 62
ϕ_m	Phase margin	vs Free-air temperature vs Supply voltage vs Load capacitance 63 64 65
	Phase shift	vs Frequency 28, 29
	Noninverting large-signal pulse response	vs Time 66
	Small-signal pulse response	vs Time 67
Z_o	Closed-loop output impedance	vs Frequency 68
	Crosstalk attenuation	vs Frequency 69

TLE207x-Q1, TLE207xA-Q1
EXCALIBUR LOW-NOISE HIGH-SPEED
JFET-INPUT OPERATIONAL AMPLIFIERS

SGLS226A – DECEMBER 2003 – REVISED AUGUST 2004

TYPICAL CHARACTERISTICS

**DISTRIBUTION OF TLE2071
 INPUT OFFSET VOLTAGE**

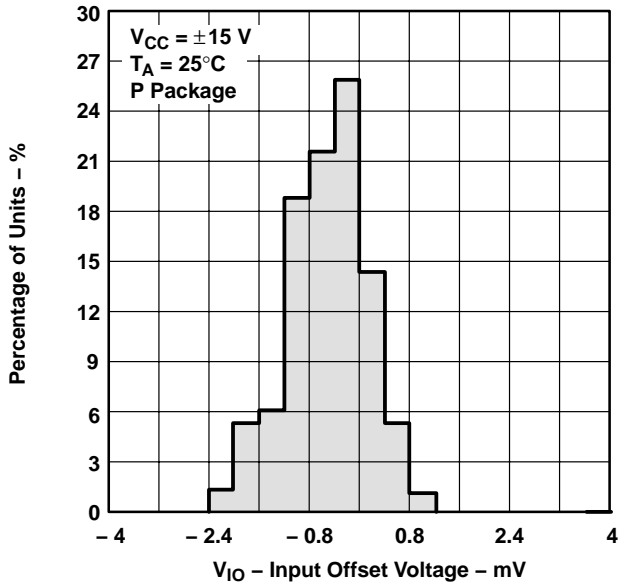

Figure 6

**DISTRIBUTION OF TLE2072
 INPUT OFFSET VOLTAGE**

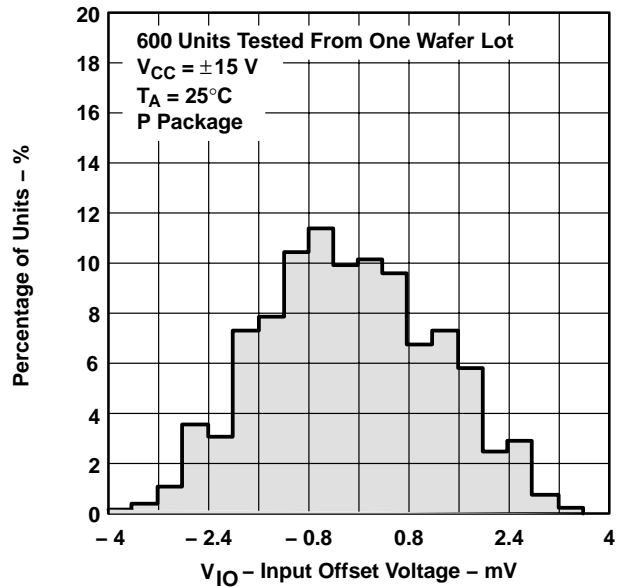

Figure 7

**DISTRIBUTION OF TLE2074
 INPUT OFFSET VOLTAGE**

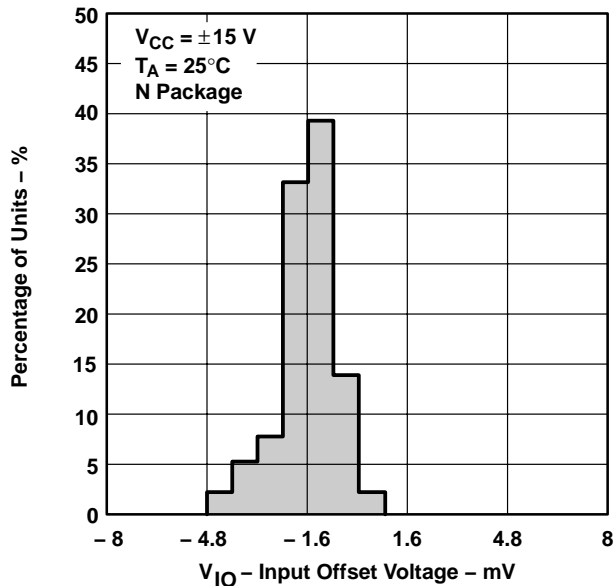

Figure 8

**DISTRIBUTION OF TLE2071 INPUT OFFSET
 VOLTAGE TEMPERATURE COEFFICIENT**

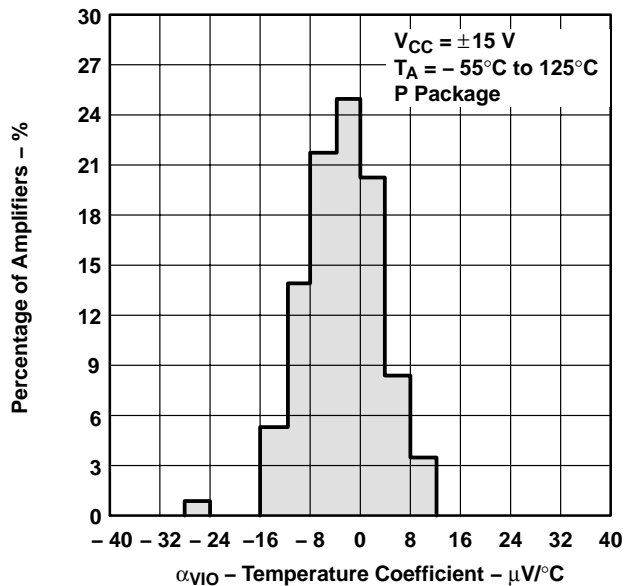

Figure 9

TYPICAL CHARACTERISTICS

**DISTRIBUTION OF TLE2072 INPUT OFFSET
 VOLTAGE TEMPERATURE COEFFICIENT**

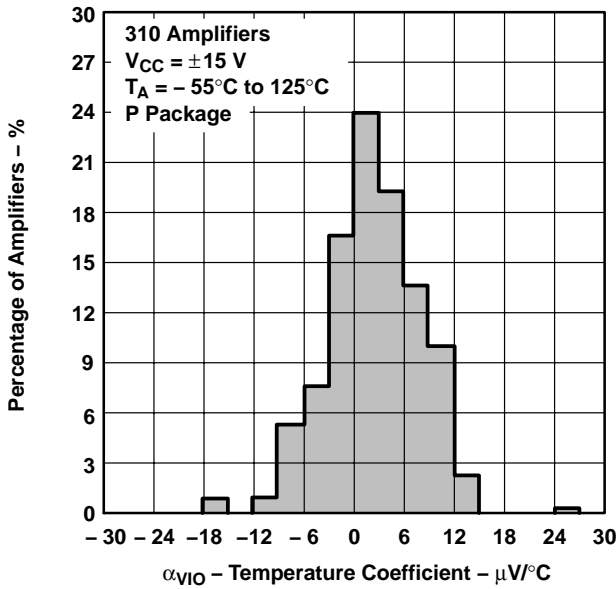

Figure 10

**DISTRIBUTION OF TLE2074 INPUT OFFSET
 VOLTAGE TEMPERATURE COEFFICIENT**

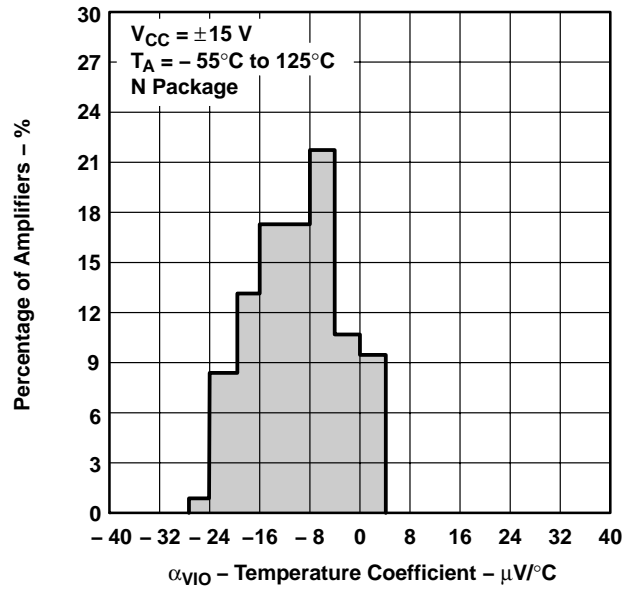

Figure 11

**INPUT BIAS CURRENT AND
 INPUT OFFSET CURRENT†
 vs
 FREE-AIR TEMPERATURE**

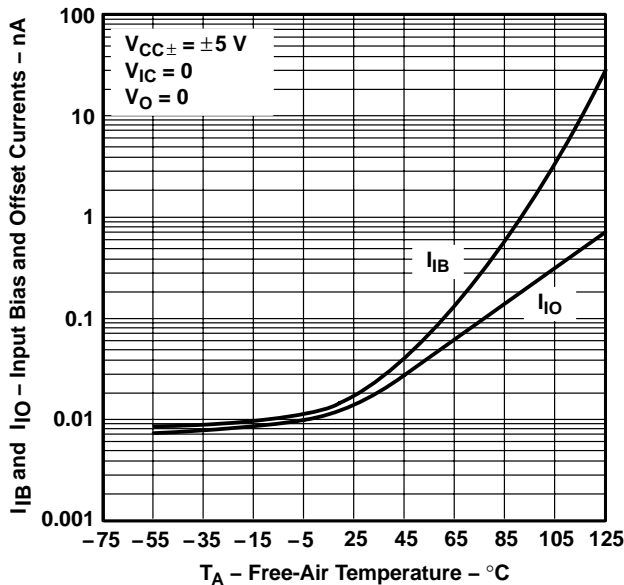

Figure 12

**INPUT BIAS CURRENT AND
 INPUT OFFSET CURRENT†
 vs
 FREE-AIR TEMPERATURE**

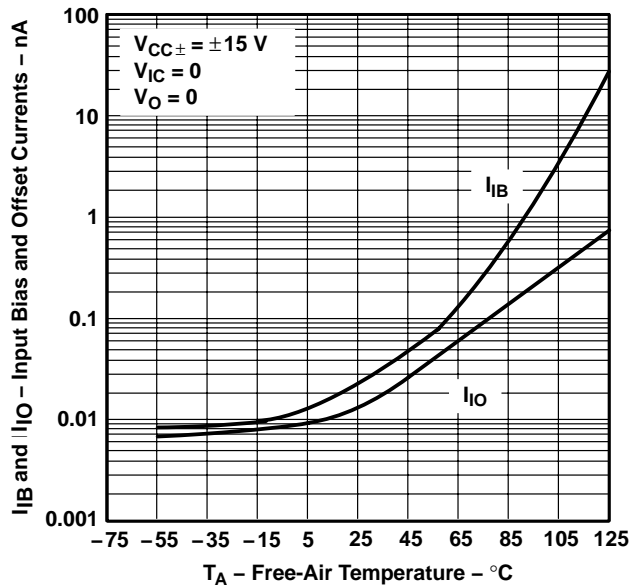

Figure 13

† Data at high and low temperatures are applicable only within the rated operating free-air temperature ranges of the various devices.

TLE207x-Q1, TLE207xA-Q1 EXCALIBUR LOW-NOISE HIGH-SPEED JFET-INPUT OPERATIONAL AMPLIFIERS

SGLS226A – DECEMBER 2003 – REVISED AUGUST 2004

TYPICAL CHARACTERISTICS

**INPUT BIAS CURRENT
vs
TOTAL SUPPLY VOLTAGE**

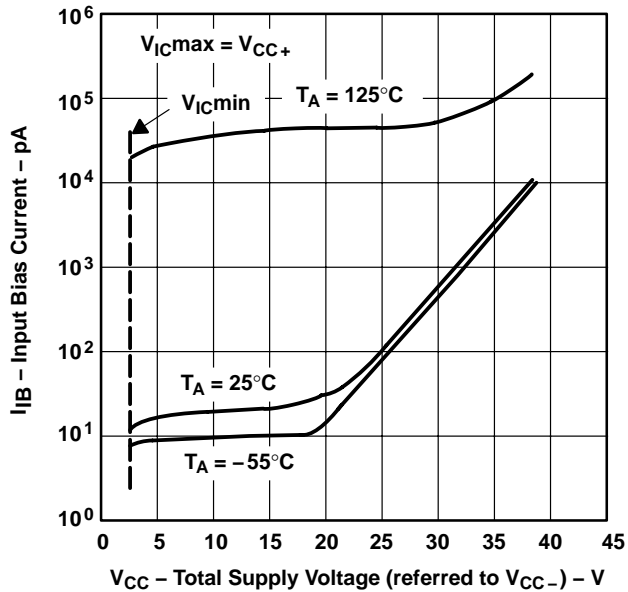

Figure 14

**COMMON-MODE INPUT VOLTAGE RANGE†
vs
FREE-AIR TEMPERATURE**

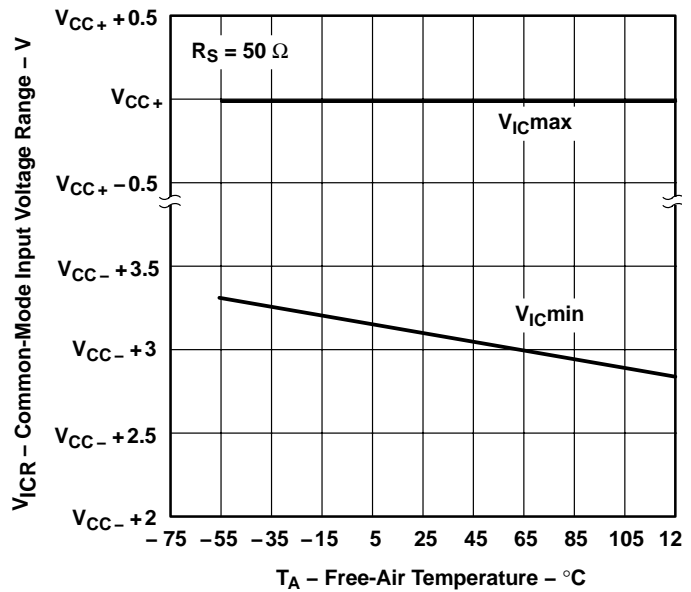

Figure 15

**OUTPUT VOLTAGE
vs
DIFFERENTIAL INPUT VOLTAGE**

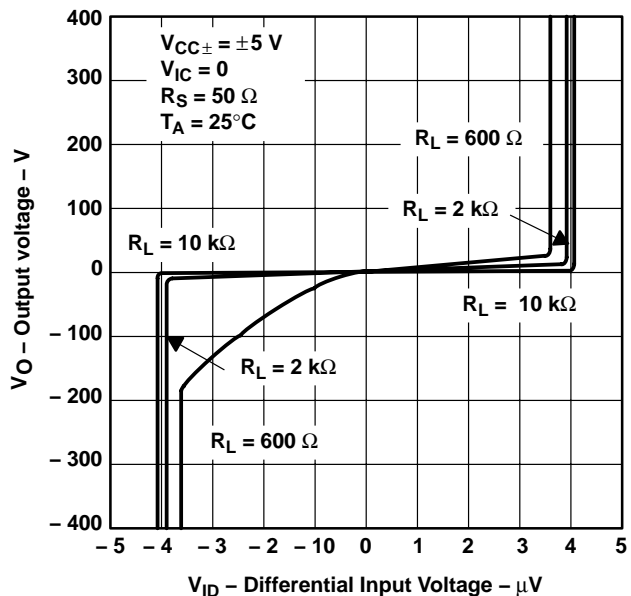

Figure 16

**OUTPUT VOLTAGE
vs
DIFFERENTIAL INPUT VOLTAGE**

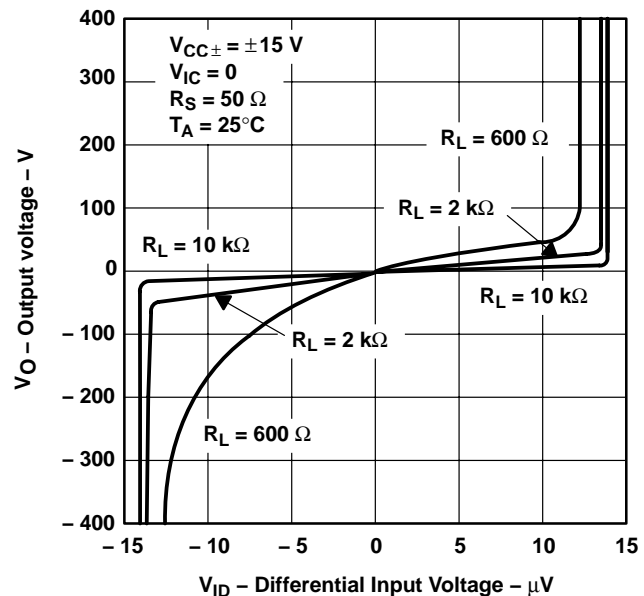

Figure 17

† Data at high and low temperatures are applicable only within the rated operating free-air temperature ranges of the various devices.

TYPICAL CHARACTERISTICS

**MAXIMUM POSITIVE PEAK OUTPUT VOLTAGE†
 vs
 OUTPUT CURRENT**

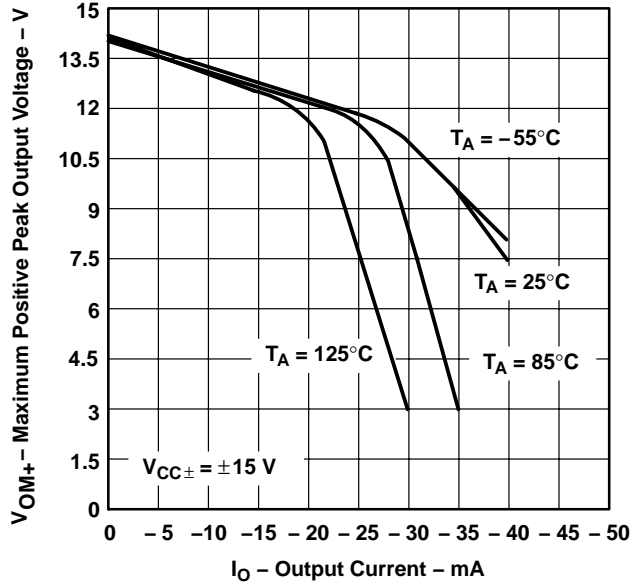

Figure 18

**MAXIMUM NEGATIVE PEAK OUTPUT VOLTAGE†
 vs
 OUTPUT CURRENT**

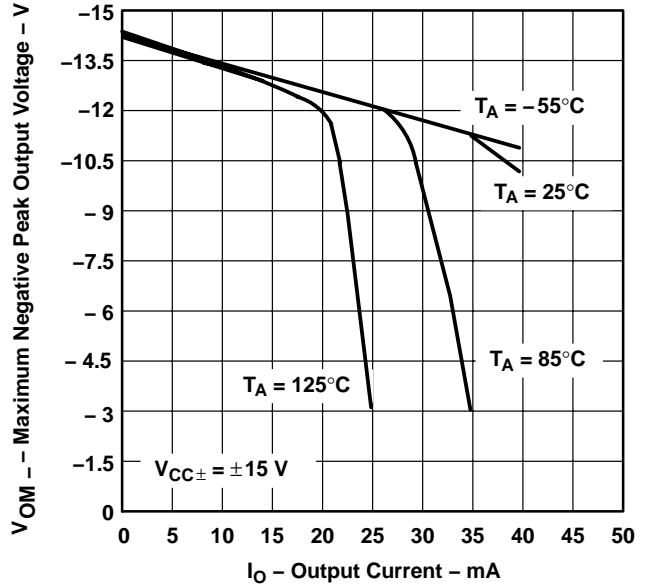

Figure 19

**MAXIMUM PEAK OUTPUT VOLTAGE†
 vs
 FREE-AIR TEMPERATURE**

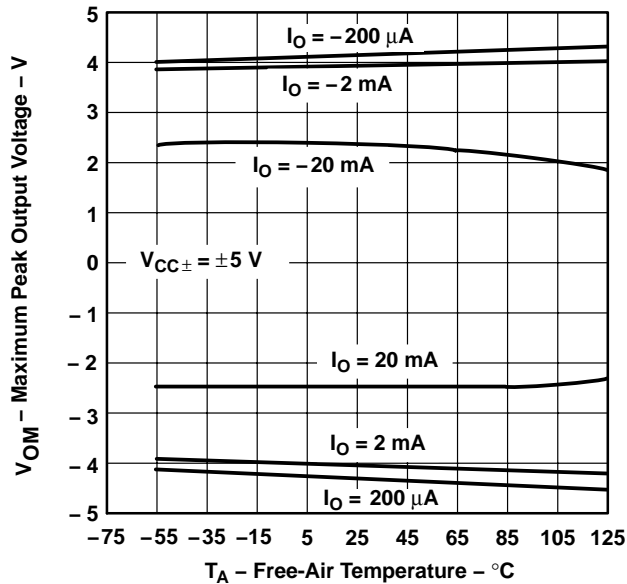

Figure 20

**MAXIMUM PEAK OUTPUT VOLTAGE†
 vs
 FREE-AIR TEMPERATURE**

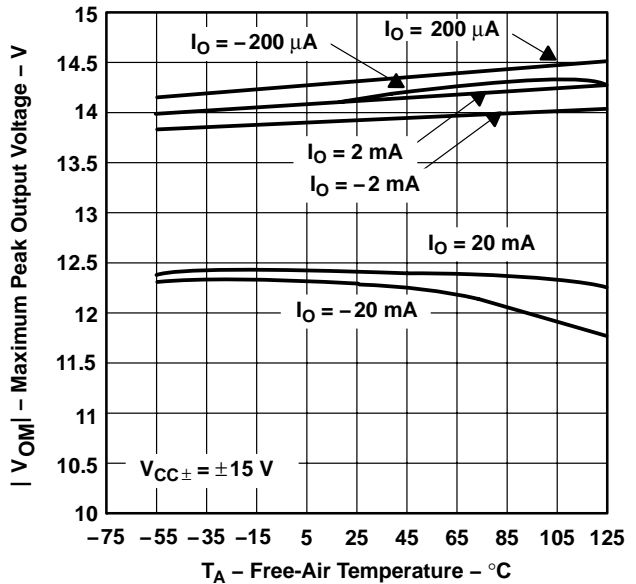

Figure 21

† Data at high and low temperatures are applicable only within the rated operating free-air temperature ranges of the various devices.

TLE207x-Q1, TLE207xA-Q1
EXCALIBUR LOW-NOISE HIGH-SPEED
JFET-INPUT OPERATIONAL AMPLIFIERS

SGLS226A – DECEMBER 2003 – REVISED AUGUST 2004

TYPICAL CHARACTERISTICS

MAXIMUM PEAK OUTPUT VOLTAGE
vs
SUPPLY VOLTAGE

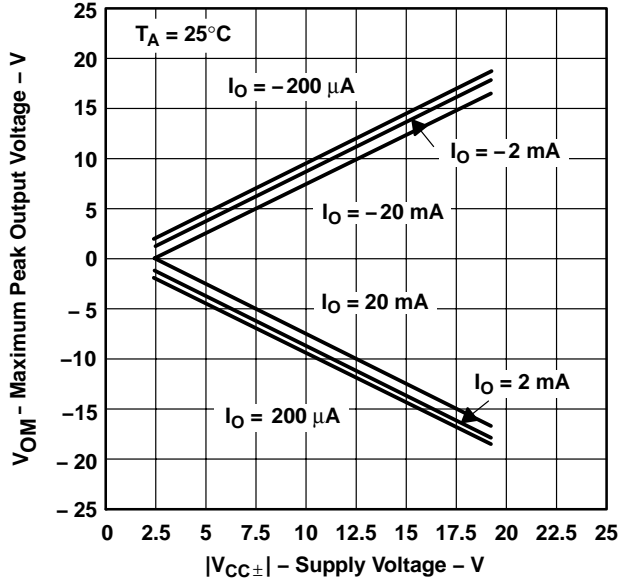

Figure 22

MAXIMUM PEAK-TO-PEAK OUTPUT VOLTAGE†
vs
FREQUENCY

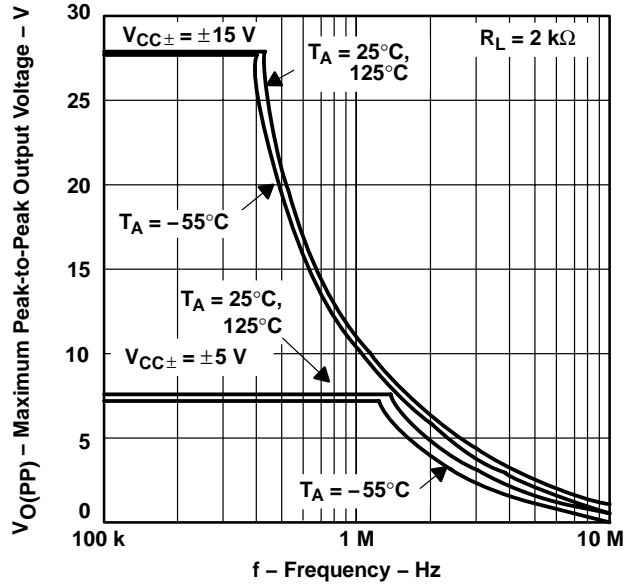

Figure 23

OUTPUT VOLTAGE
vs
SETTLING TIME

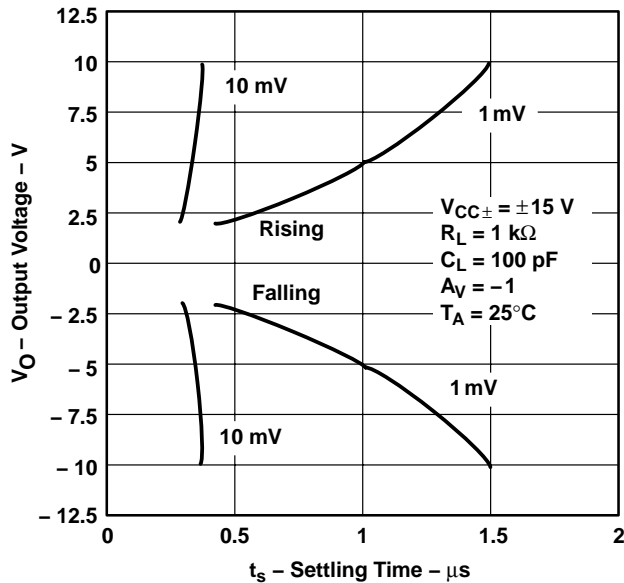

Figure 24

LARGE-SIGNAL DIFFERENTIAL
VOLTAGE AMPLIFICATION
vs
LOAD RESISTANCE

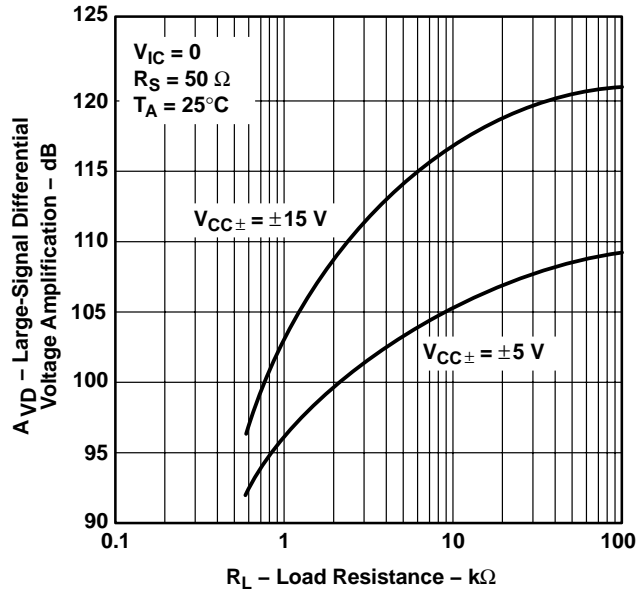

Figure 25

† Data at high and low temperatures are applicable only within the rated operating free-air temperature ranges of the various devices.



TYPICAL CHARACTERISTICS

**LARGE-SIGNAL DIFFERENTIAL
 VOLTAGE AMPLIFICATION†
 vs
 FREE-AIR TEMPERATURE**

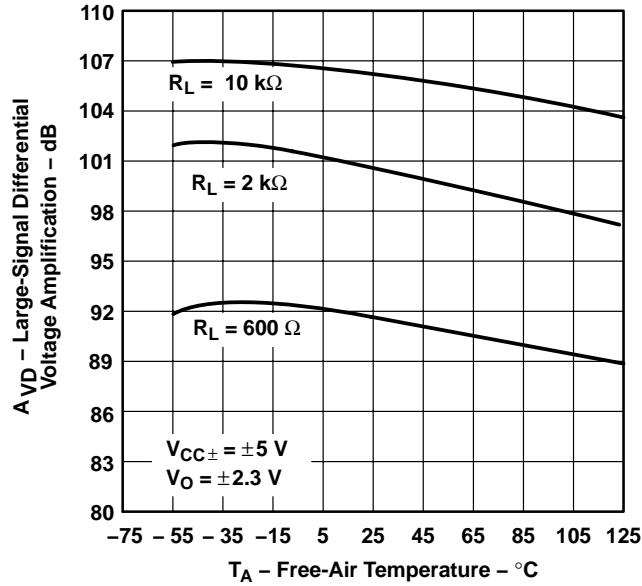

Figure 26

**LARGE-SIGNAL DIFFERENTIAL
 VOLTAGE AMPLIFICATION†
 vs
 FREE-AIR TEMPERATURE**

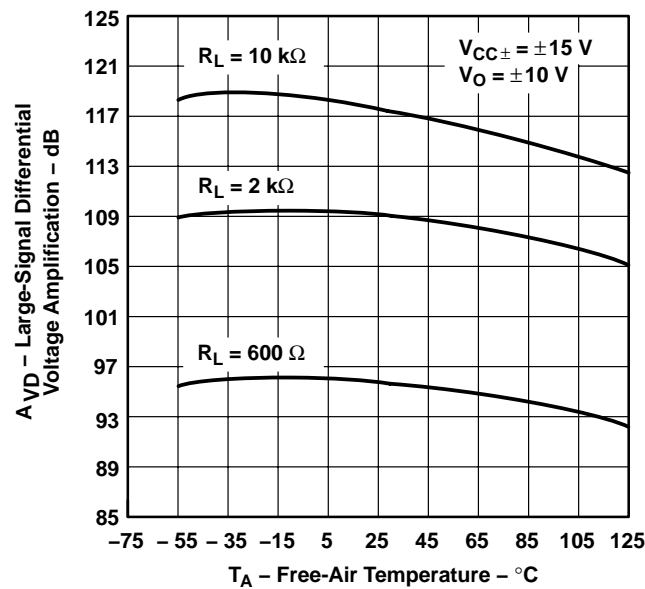

Figure 27

† Data at high and low temperatures are applicable only within the rated operating free-air temperature ranges of the various devices.

TLE207x-Q1, TLE207xA-Q1
EXCALIBUR LOW-NOISE HIGH-SPEED
JFET-INPUT OPERATIONAL AMPLIFIERS

SGLS226A – DECEMBER 2003 – REVISED AUGUST 2004

TYPICAL CHARACTERISTICS

SMALL-SIGNAL DIFFERENTIAL VOLTAGE
AMPLIFICATION AND PHASE SHIFT

vs

FREQUENCY

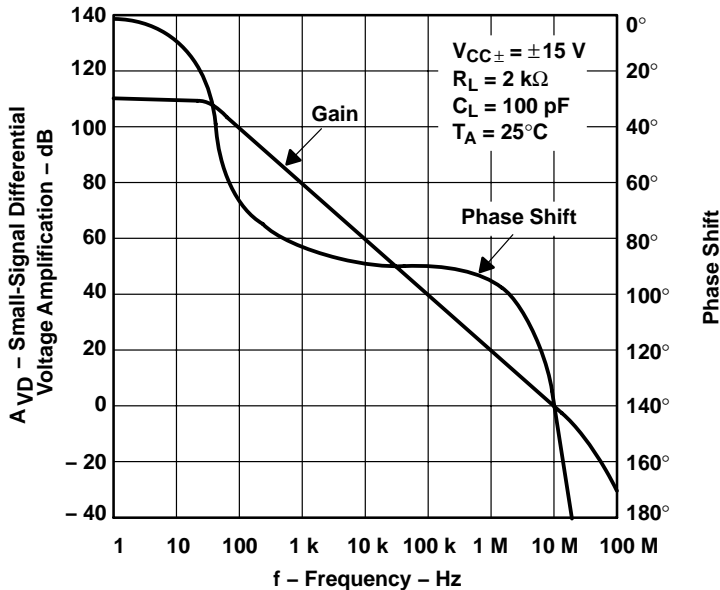

Figure 28

SMALL-SIGNAL DIFFERENTIAL VOLTAGE
AMPLIFICATION AND PHASE SHIFT

vs

FREQUENCY

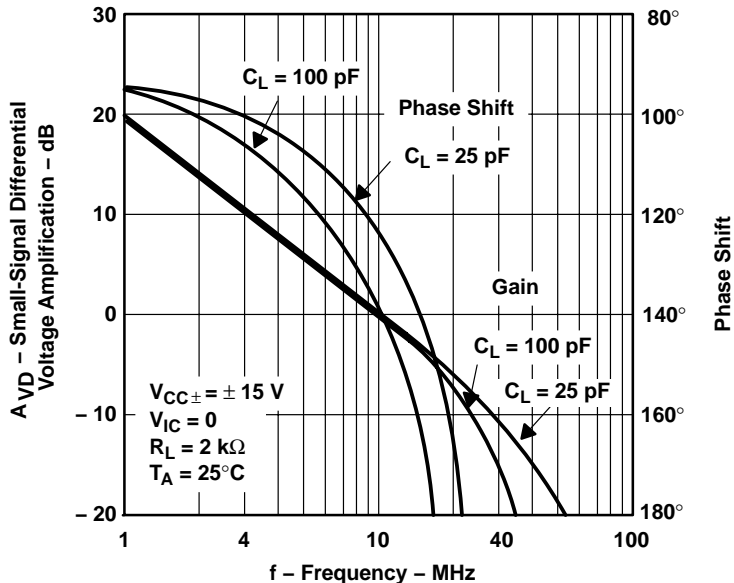

Figure 29



TYPICAL CHARACTERISTICS

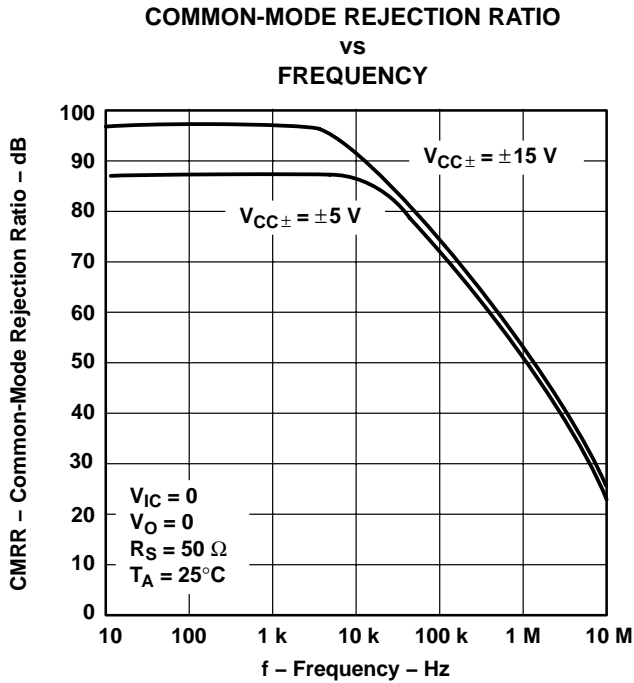

Figure 30

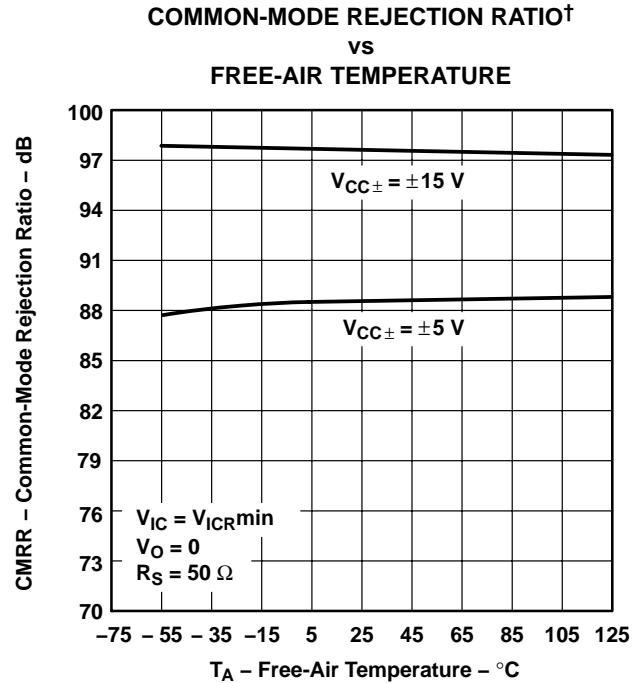

Figure 31

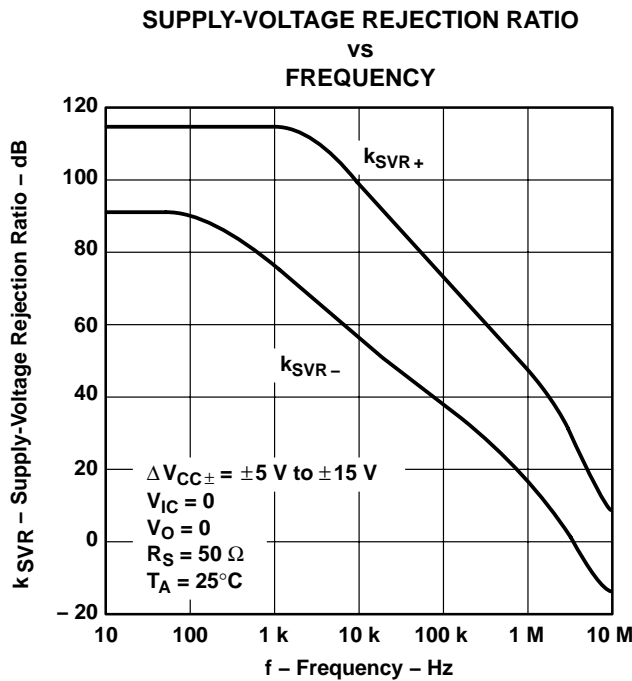

Figure 32

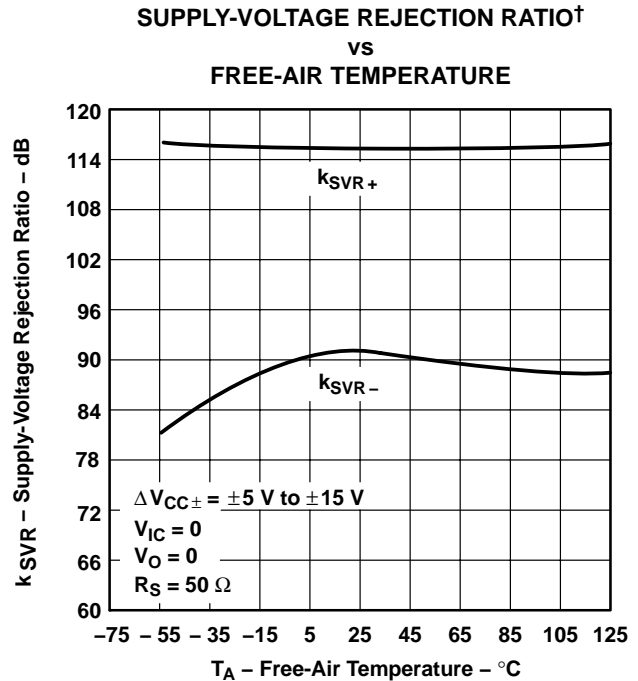

Figure 33

† Data at high and low temperatures are applicable only within the rated operating free-air temperature ranges of the various devices.

TLE207x-Q1, TLE207xA-Q1
EXCALIBUR LOW-NOISE HIGH-SPEED
JFET-INPUT OPERATIONAL AMPLIFIERS

SGLS226A – DECEMBER 2003 – REVISED AUGUST 2004

TYPICAL CHARACTERISTICS

TLE2071
SUPPLY CURRENT
vs
SUPPLY VOLTAGE

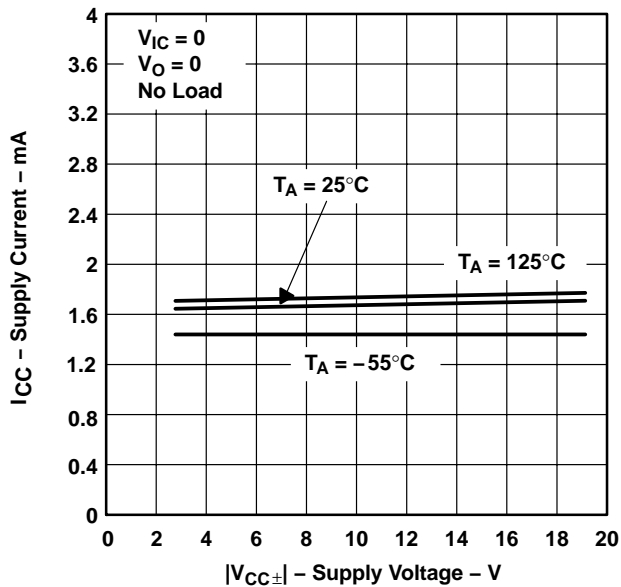

Figure 34

TLE2072
SUPPLY CURRENT
vs
SUPPLY VOLTAGE

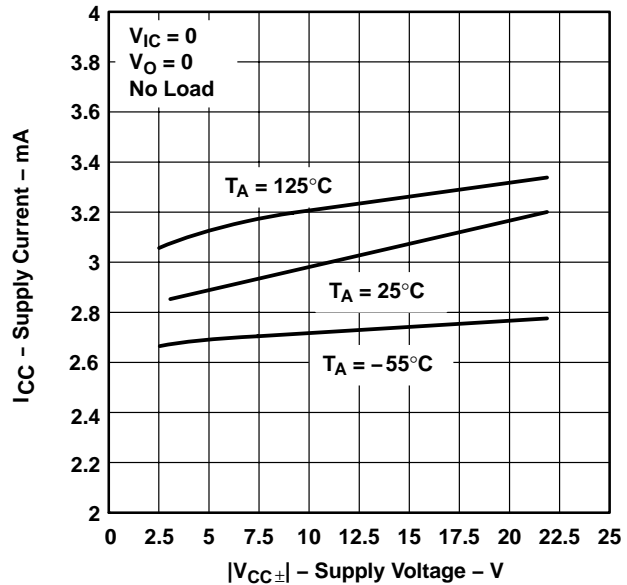

Figure 35

TLE2074
SUPPLY CURRENT
vs
SUPPLY VOLTAGE

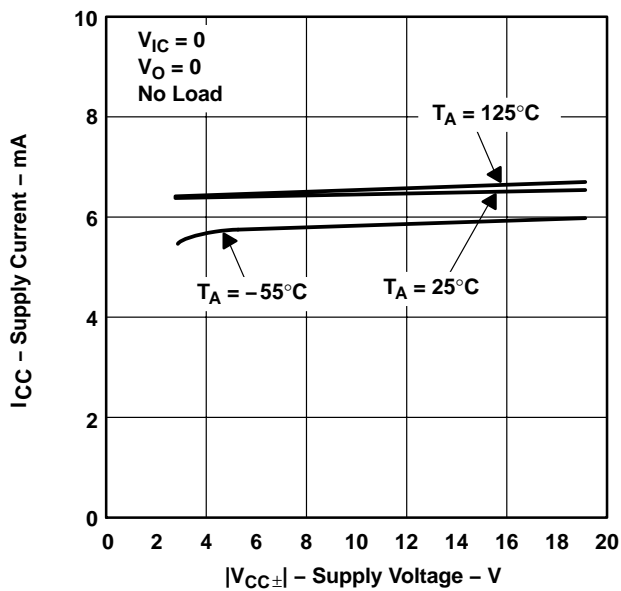

Figure 36

TLE2071
SUPPLY CURRENT†
vs
FREE-AIR TEMPERATURE

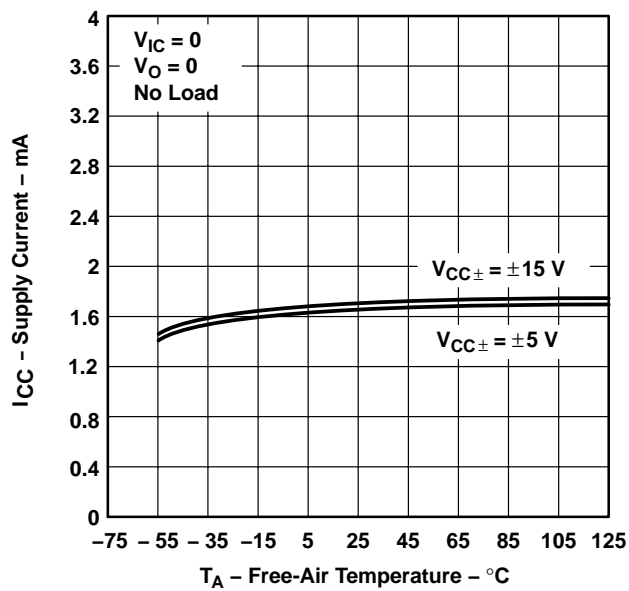
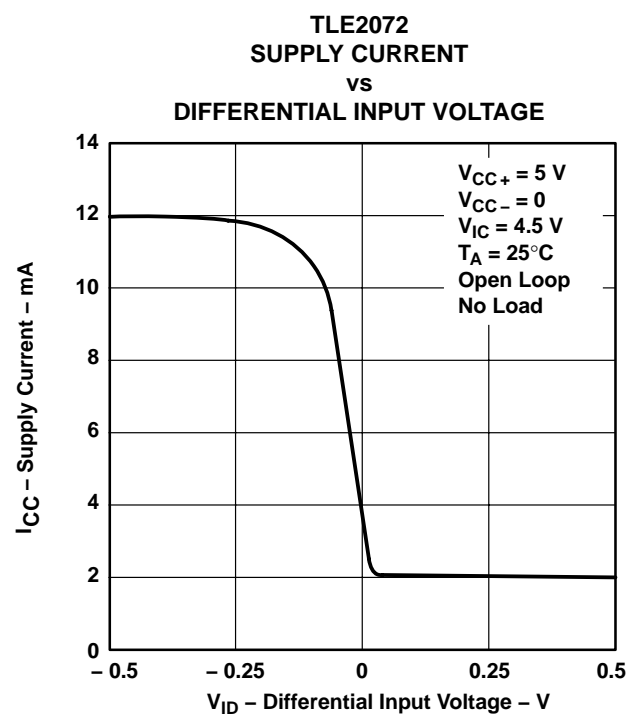
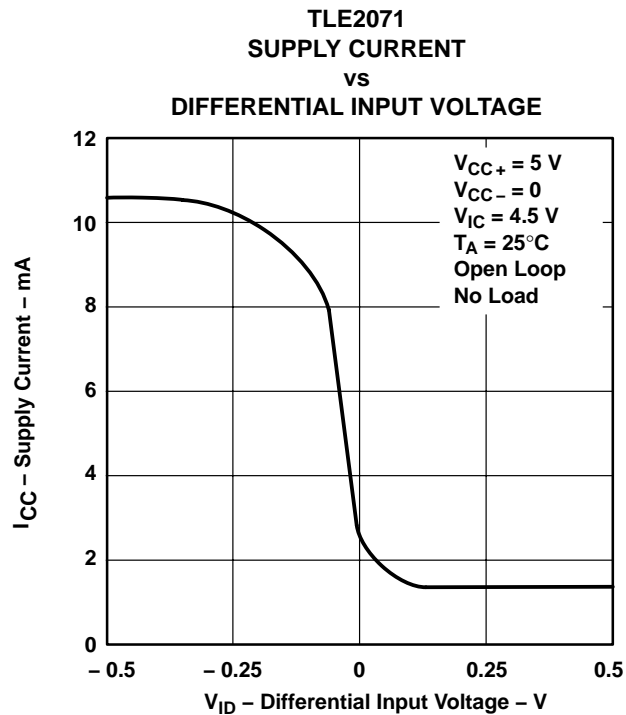
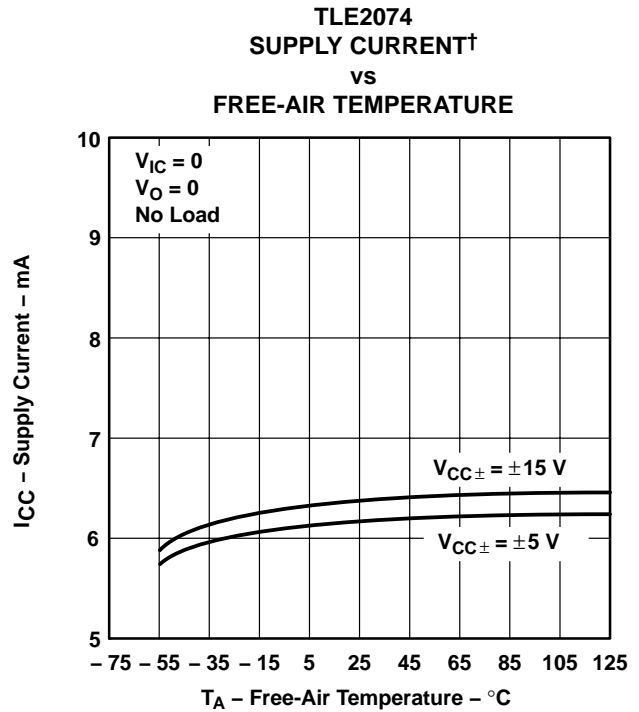
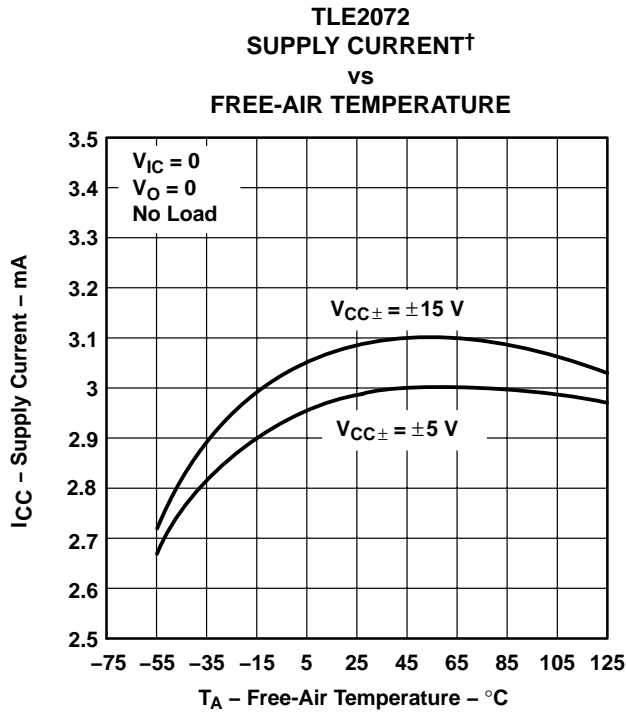

Figure 37

† Data at high and low temperatures are applicable only within the rated operating free-air temperature ranges of the various devices.

TYPICAL CHARACTERISTICS



† Data at high and low temperatures are applicable only within the rated operating free-air temperature ranges of the various devices.

TLE207x-Q1, TLE207xA-Q1
EXCALIBUR LOW-NOISE HIGH-SPEED
JFET-INPUT OPERATIONAL AMPLIFIERS

SGLS226A – DECEMBER 2003 – REVISED AUGUST 2004

TYPICAL CHARACTERISTICS

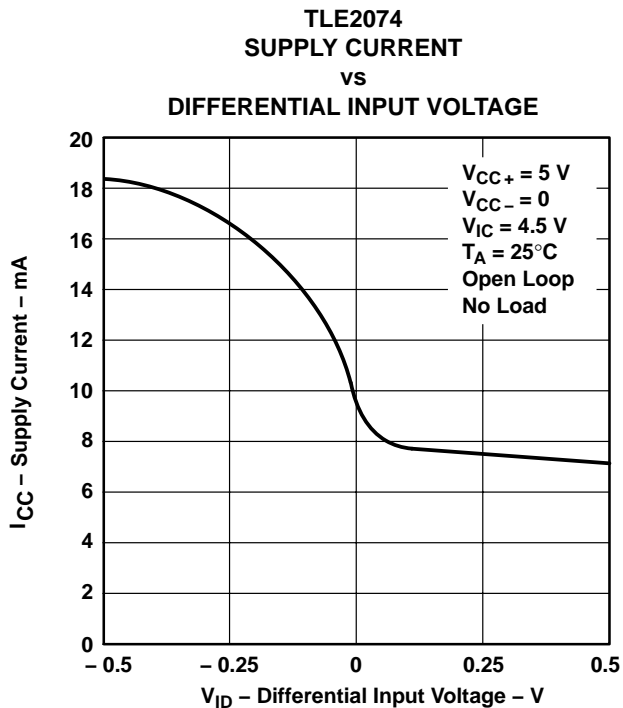

Figure 42

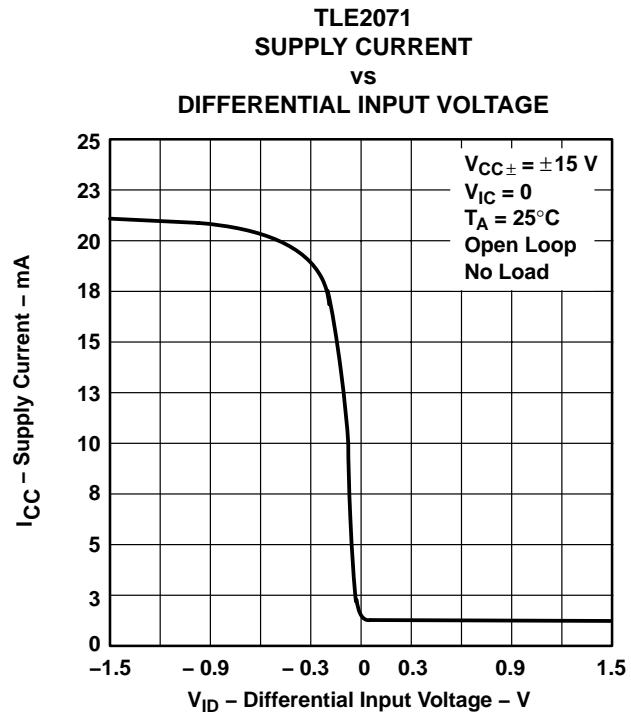

Figure 43

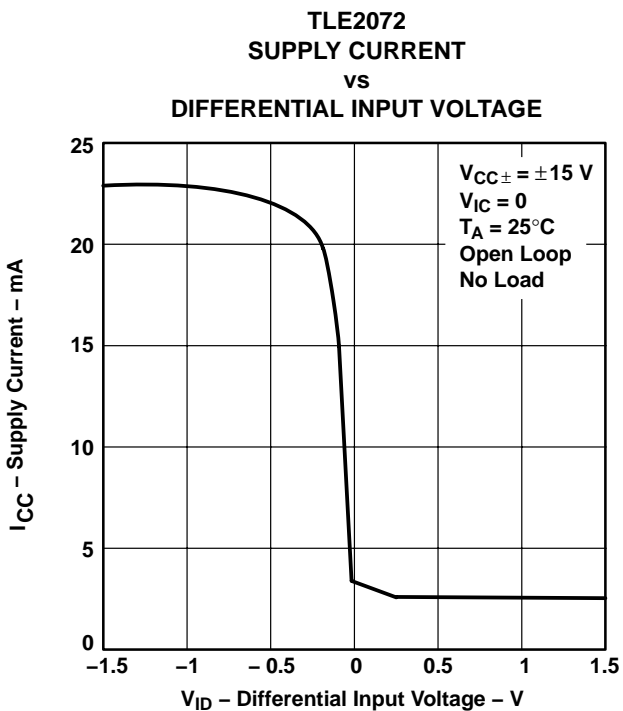

Figure 44

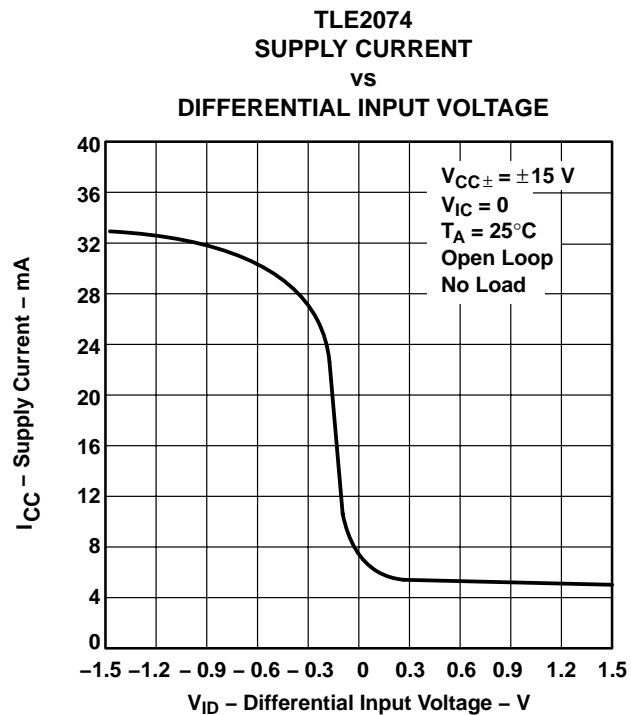

Figure 45



TYPICAL CHARACTERISTICS

**SHORT-CIRCUIT OUTPUT CURRENT
 vs
 SUPPLY VOLTAGE**

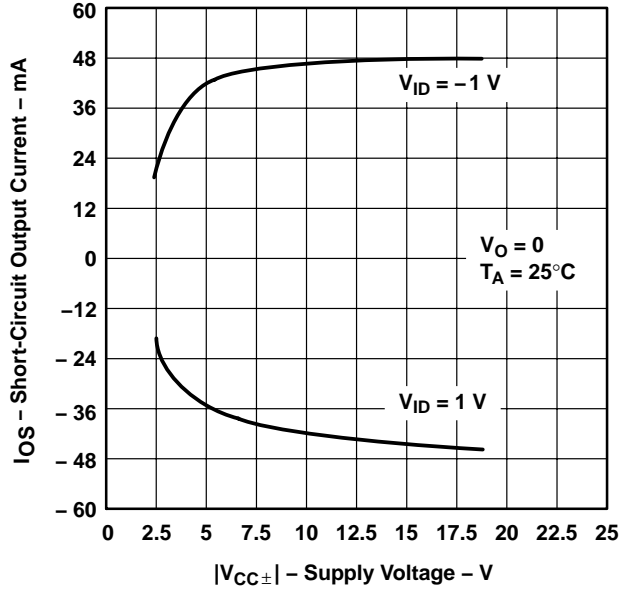

Figure 46

**SHORT-CIRCUIT OUTPUT CURRENT
 vs
 ELAPSED TIME**

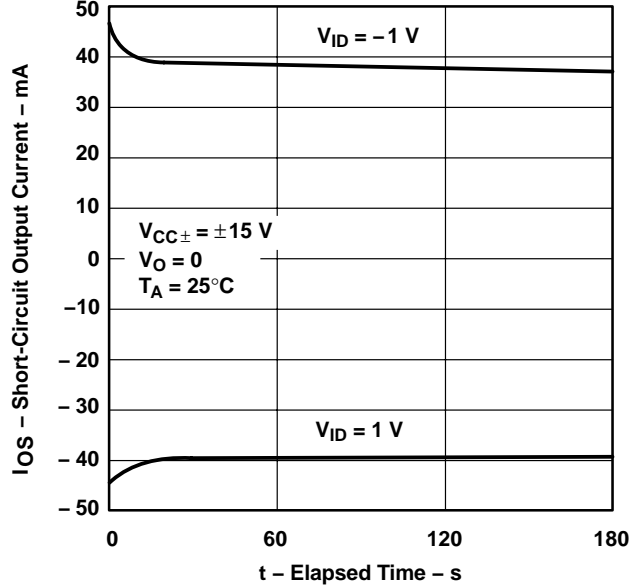

Figure 47

**SHORT-CIRCUIT OUTPUT CURRENT†
 vs
 FREE-AIR TEMPERATURE**

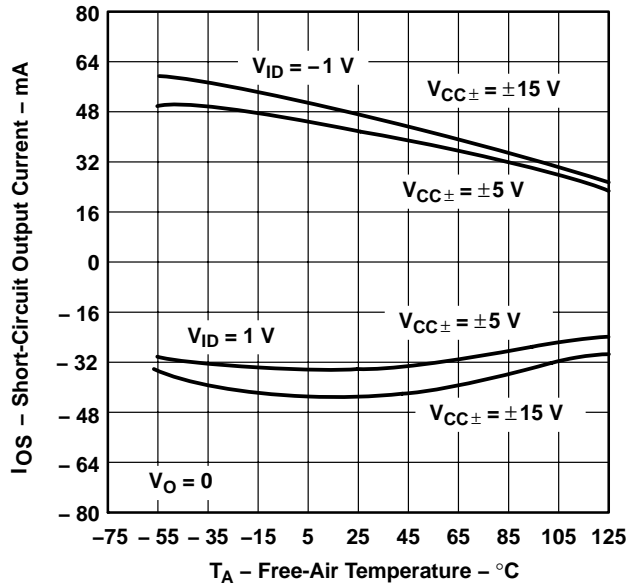

Figure 48

**SLEW RATE†
 vs
 FREE-AIR TEMPERATURE**

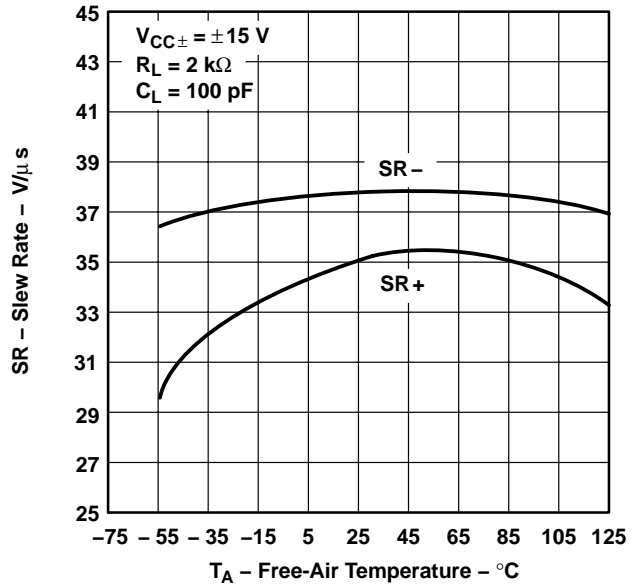

Figure 49

† Data at high and low temperatures are applicable only within the rated operating free-air temperature ranges of the various devices.

TLE207x-Q1, TLE207xA-Q1
EXCALIBUR LOW-NOISE HIGH-SPEED
JFET-INPUT OPERATIONAL AMPLIFIERS

SGLS226A – DECEMBER 2003 – REVISED AUGUST 2004

TYPICAL CHARACTERISTICS

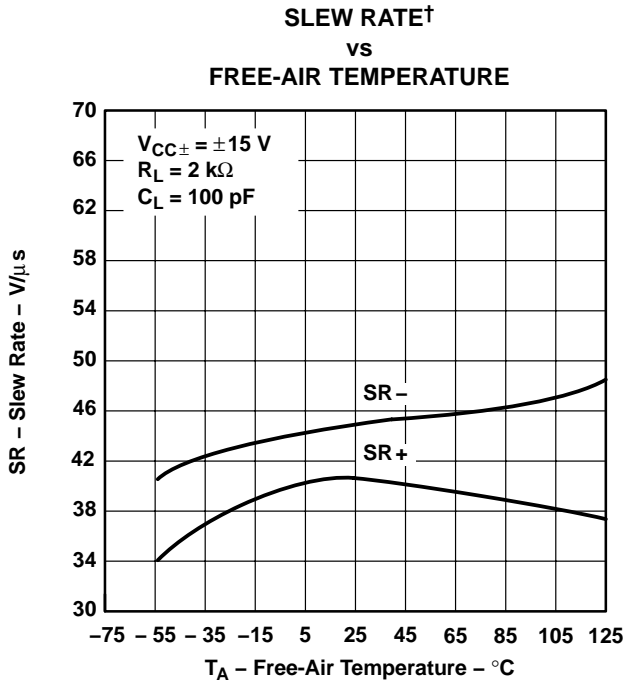

Figure 50

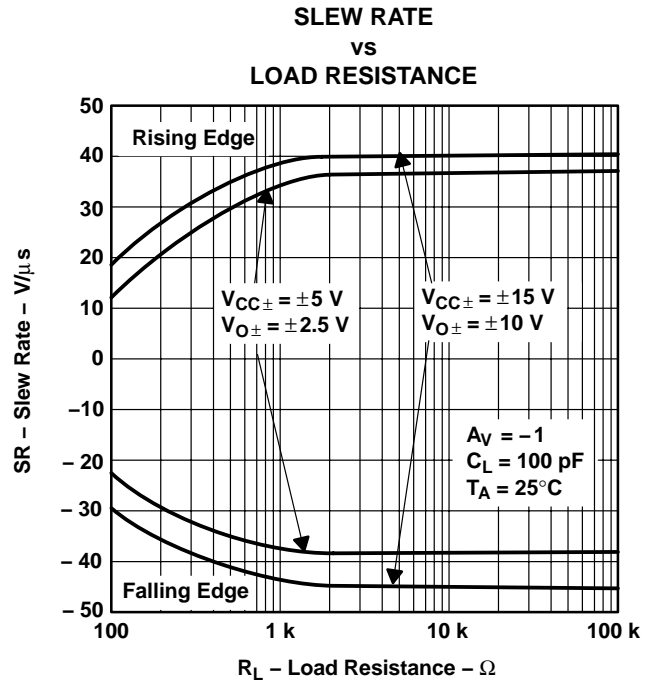

Figure 51

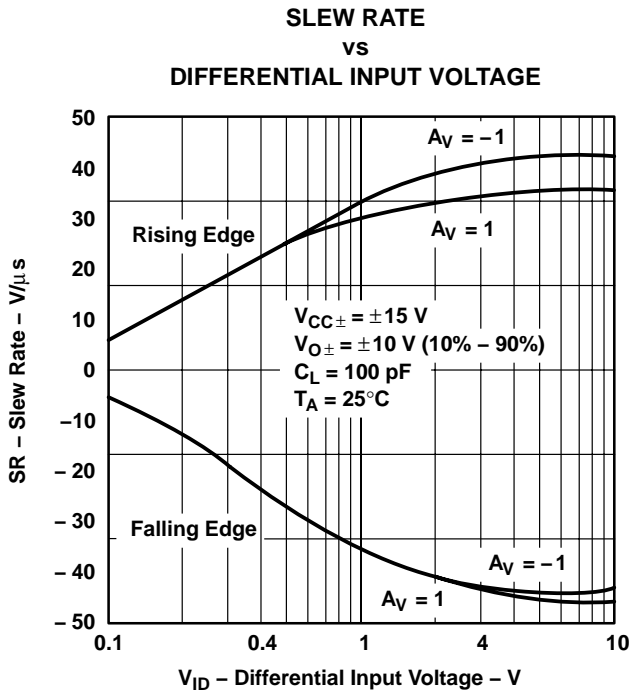

Figure 52

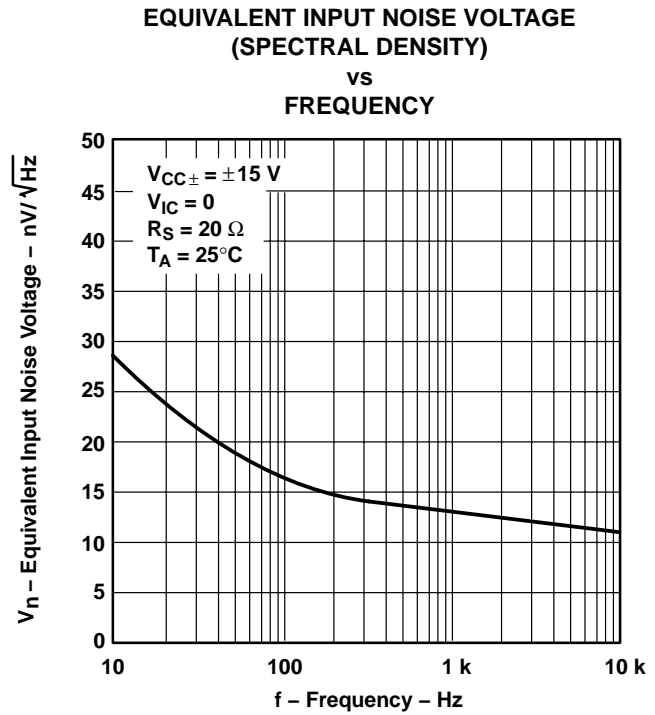

Figure 53

† Data at high and low temperatures are applicable only within the rated operating free-air temperature ranges of the various devices.

TYPICAL CHARACTERISTICS

**INPUT-REFERRED NOISE VOLTAGE
 VS
 NOISE BANDWIDTH**

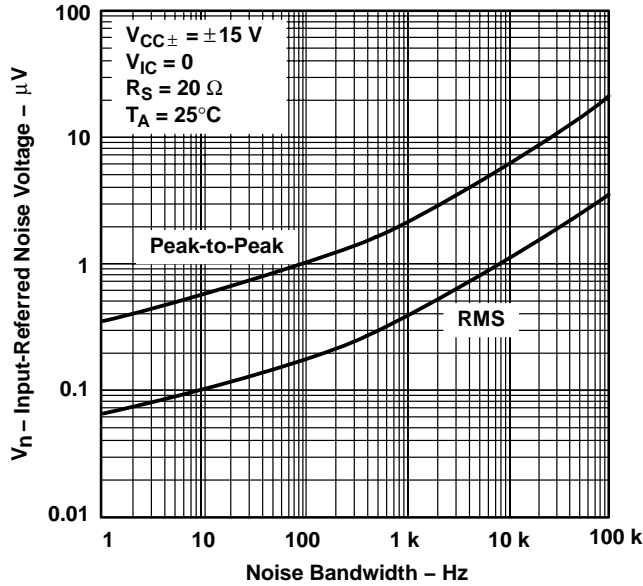

Figure 54

**INPUT-REFERRED NOISE VOLTAGE
 OVER A 10-SECOND TIME INTERVAL**

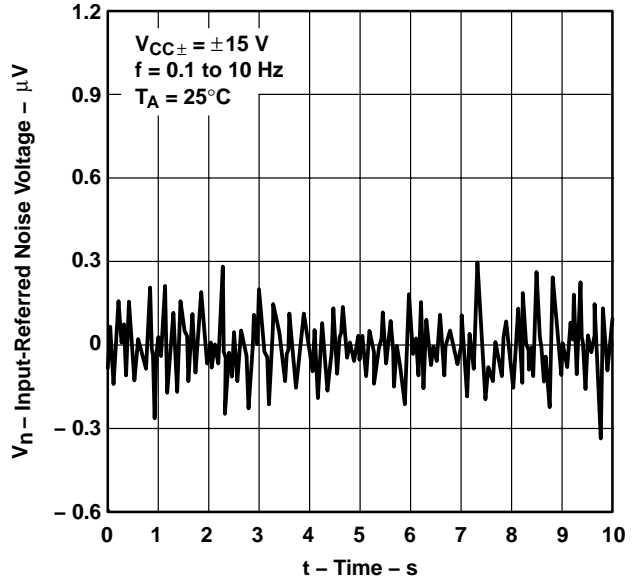

Figure 55

**THIRD-OCTAVE SPECTRAL NOISE DENSITY
 VS
 FREQUENCY BANDS**

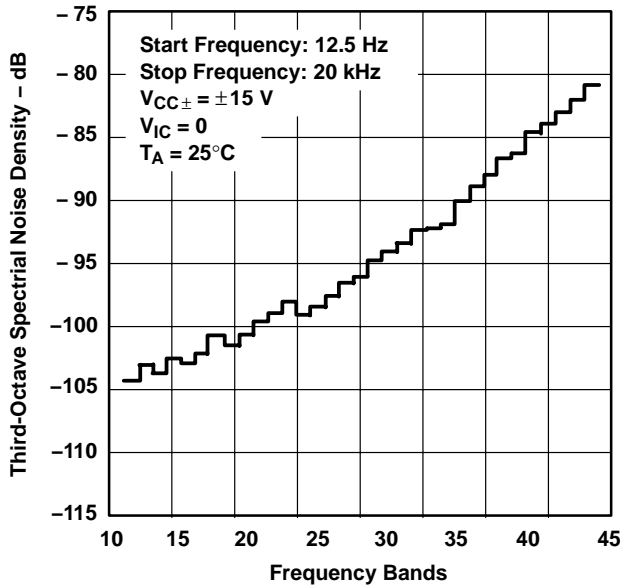

Figure 56

**TOTAL HARMONIC DISTORTION PLUS NOISE
 VS
 FREQUENCY**

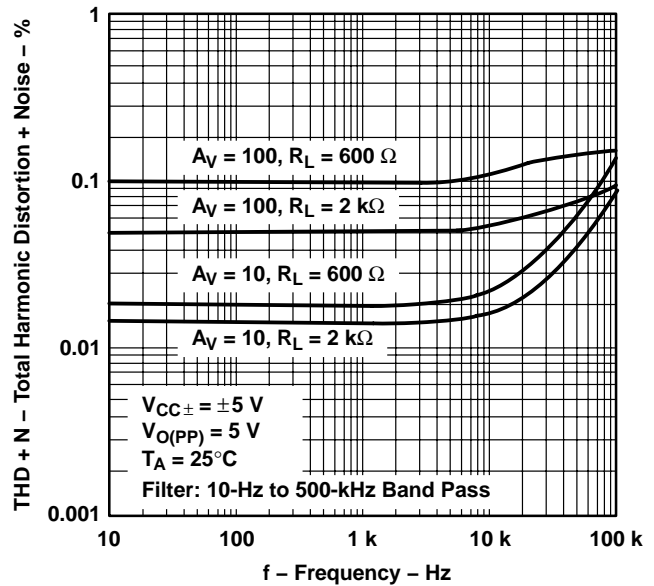

Figure 57

TLE207x-Q1, TLE207xA-Q1 EXCALIBUR LOW-NOISE HIGH-SPEED JFET-INPUT OPERATIONAL AMPLIFIERS

SGLS226A – DECEMBER 2003 – REVISED AUGUST 2004

TYPICAL CHARACTERISTICS

**TOTAL HARMONIC DISTORTION PLUS NOISE
vs
FREQUENCY**

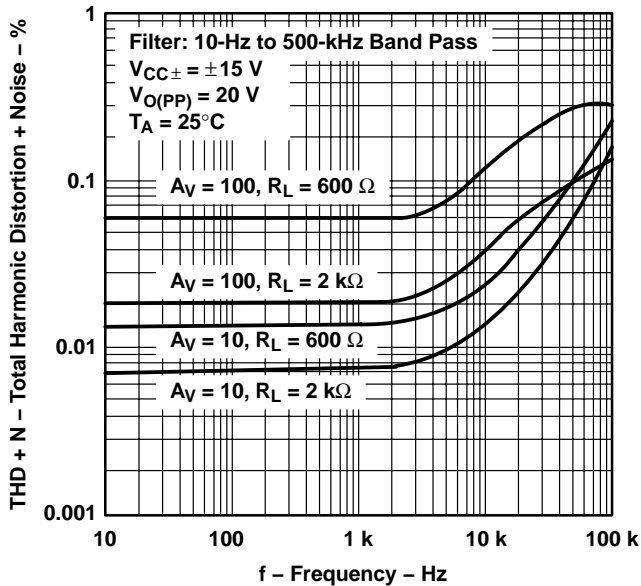

Figure 58

**UNITY-GAIN BANDWIDTH
vs
LOAD CAPACITANCE**

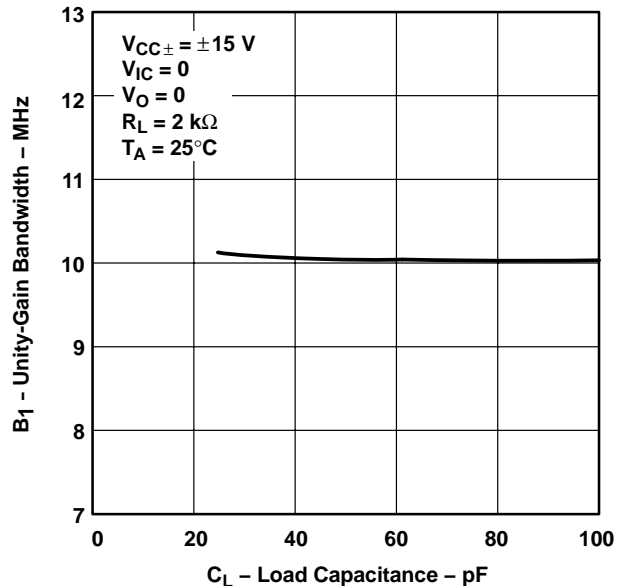

Figure 59

**GAIN-BANDWIDTH PRODUCT†
vs
FREE-AIR TEMPERATURE**

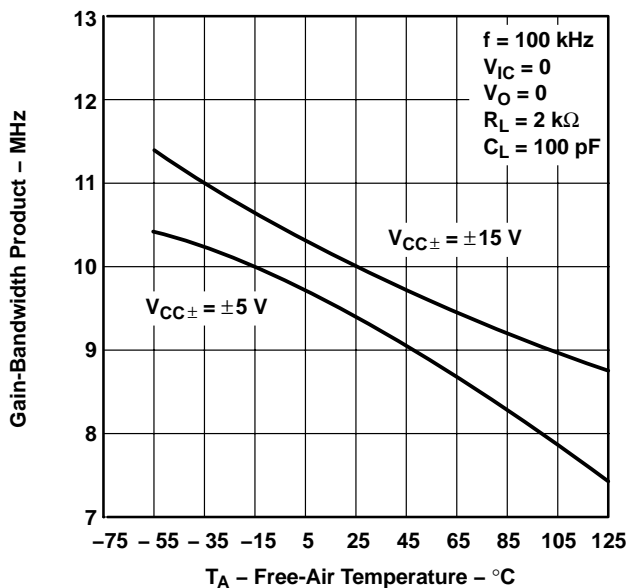

Figure 60

**GAIN-BANDWIDTH PRODUCT
vs
SUPPLY VOLTAGE**

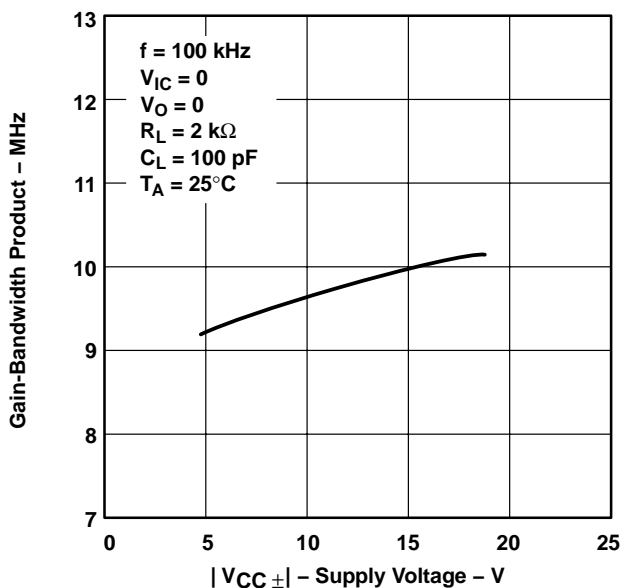

Figure 61

† Data at high and low temperatures are applicable only within the rated operating free-air temperature ranges of the various devices.

TYPICAL CHARACTERISTICS

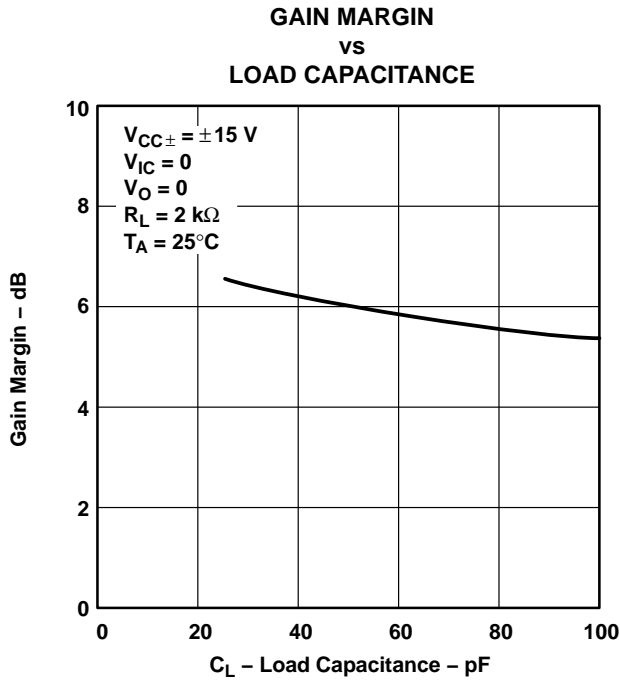

Figure 62

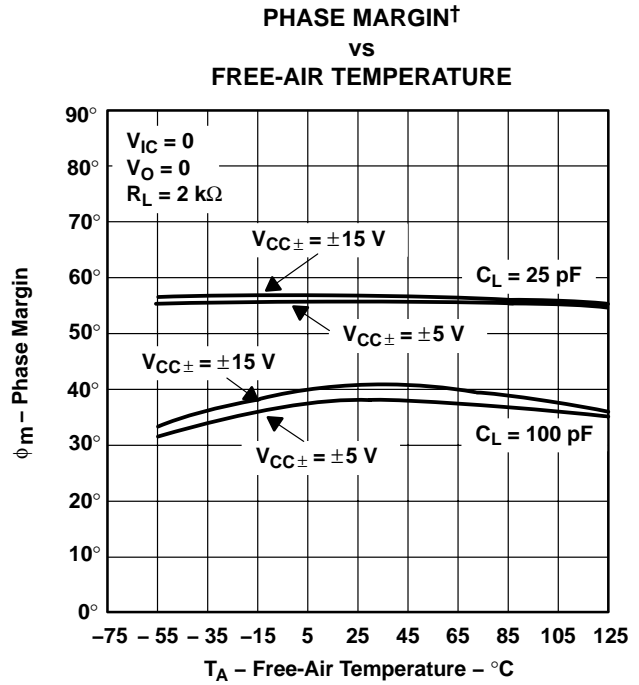

Figure 63

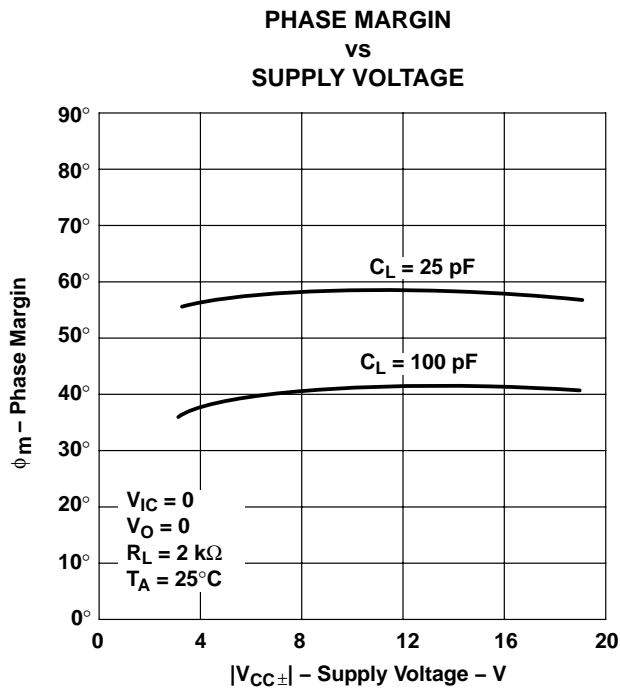

Figure 64

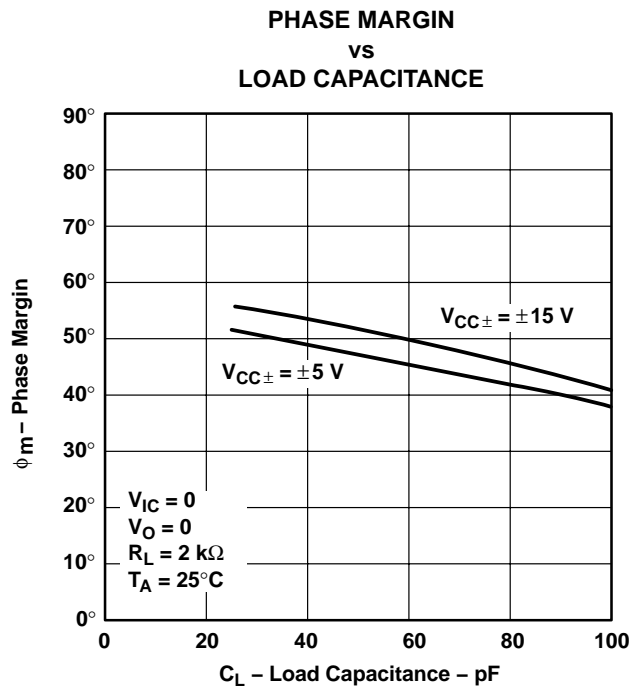

Figure 65

† Data at high and low temperatures are applicable only within the rated operating free-air temperature ranges of the various devices.

TLE207x-Q1, TLE207xA-Q1 EXCALIBUR LOW-NOISE HIGH-SPEED JFET-INPUT OPERATIONAL AMPLIFIERS

SGLS226A – DECEMBER 2003 – REVISED AUGUST 2004

TYPICAL CHARACTERISTICS

**NONINVERTING LARGE-SIGNAL
PULSE RESPONSE†**

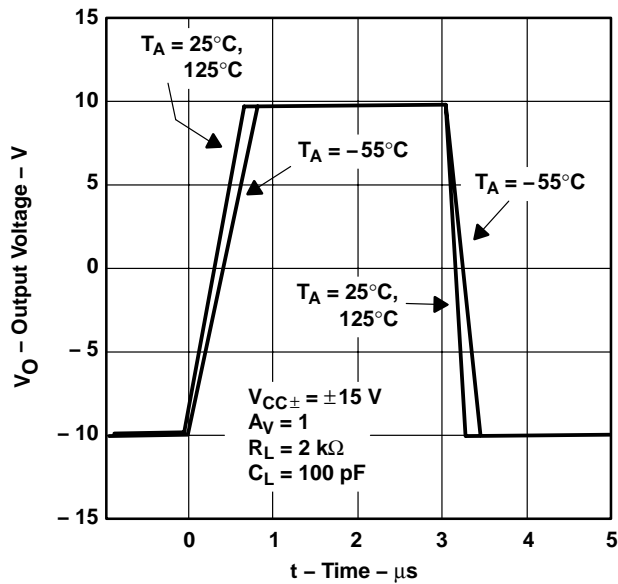

Figure 66

SMALL-SIGNAL PULSE RESPONSE

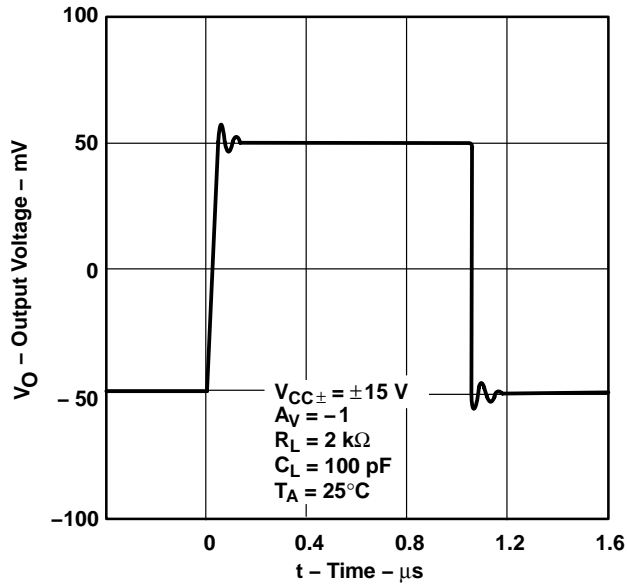

Figure 67

**CLOSED-LOOP OUTPUT IMPEDANCE
vs
FREQUENCY**

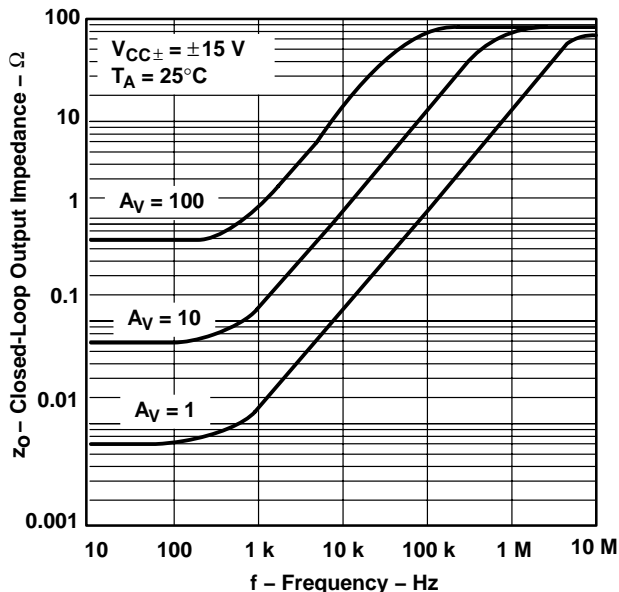

Figure 68

**TLE2072 AND TLE2074
CROSSTALK ATTENUATION
vs
FREQUENCY**

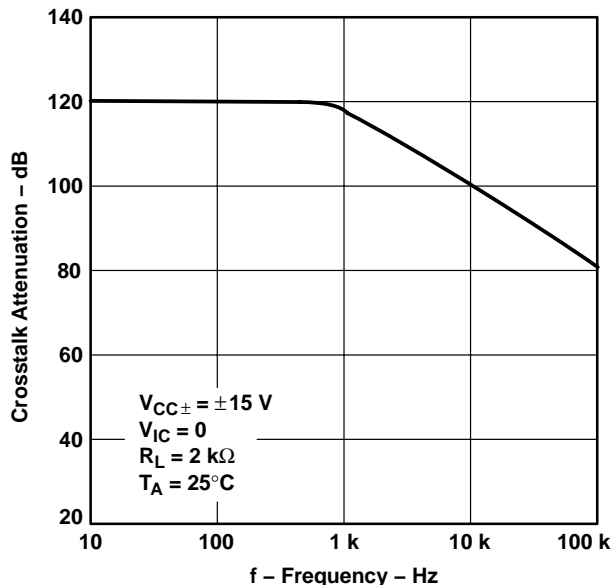

Figure 69

† Data at high and low temperatures are applicable only within the rated operating free-air temperature ranges of the various devices.

APPLICATION INFORMATION

input characteristics

The TLE207x, TLE207xA, and TLE207xB are specified with a minimum and a maximum input voltage that if exceeded at either input could cause the device to malfunction. Because of the extremely high input impedance and resulting low bias current requirements, the TLE207x, TLE207xA, and TLE207xB are well suited for low-level signal processing; however, leakage currents on printed-circuit boards and sockets can easily exceed bias current requirements and cause degradation in system performance. It is good practice to include guard rings around inputs (see Figure 70). These guards should be driven from a low-impedance source at the same voltage level as the common-mode input.

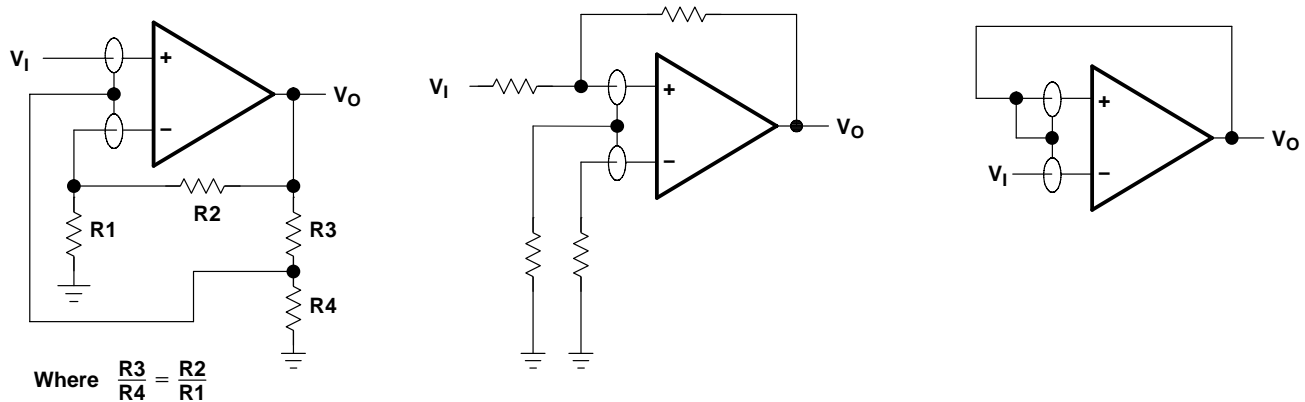

Figure 70. Use of Guard Rings

TLE2071 input offset voltage nulling

The TLE2071 series offers external null pins that can be used to further reduce the input offset voltage. The circuit of Figure 71 can be connected as shown if the feature is desired. When external nulling is not needed, the null pins may be left unconnected.

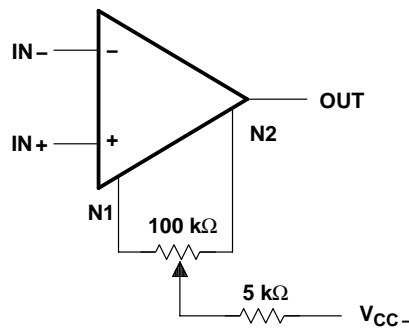

Figure 71. Input Offset Voltage Nulling

TLE207x-Q1, TLE207xA-Q1 EXCALIBUR LOW-NOISE HIGH-SPEED JFET-INPUT OPERATIONAL AMPLIFIERS

SGLS226A – DECEMBER 2003 – REVISED AUGUST 2004

APPLICATION INFORMATION

macromodel information

Macromodel information provided was derived using *PSpice™ Parts™* model generation software. The Boyle macromodel (see Note 4) and subcircuit Figure 72 were generated using the TLE207x typical electrical and operating characteristics at $T_A = 25^\circ\text{C}$. Using this information, output simulations of the following key parameters can be generated to a tolerance of 20% (in most cases):

- Maximum positive output voltage swing
- Maximum negative output voltage swing
- Slew rate
- Quiescent power dissipation
- Input bias current
- Open-loop voltage amplification
- Unity-gain frequency
- Common-mode rejection ratio
- Phase margin
- DC output resistance
- AC output resistance
- Short-circuit output current limit

NOTE 4: G.R. Boyle, B.M. Cohn, D. O. Pederson, and J. E. Solomon, "Macromodeling of Integrated Circuit Operational Amplifiers", *IEEE Journal of Solid-State Circuits*, SC-9, 353 (1974).

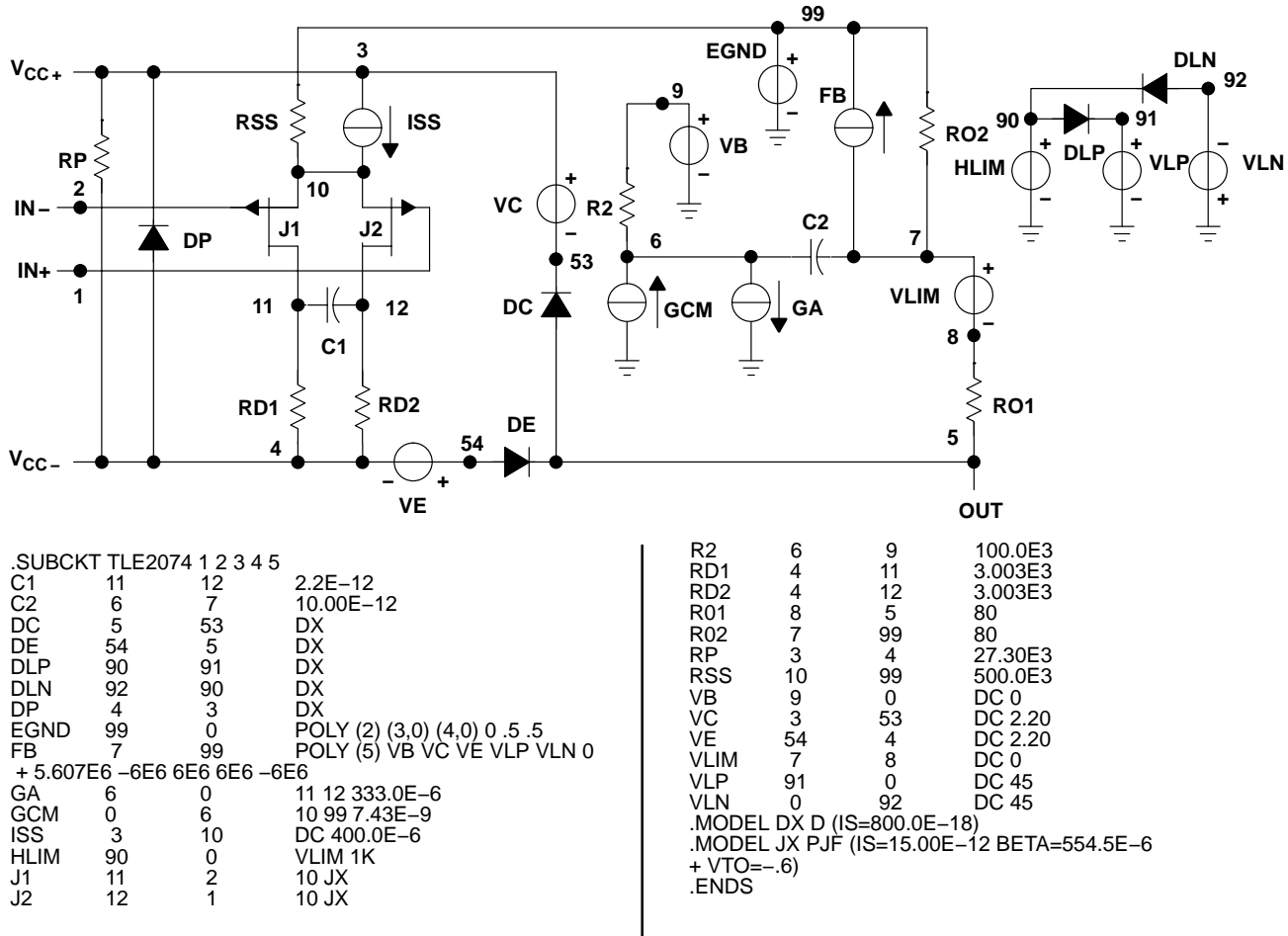

Figure 72. Boyle Macromodel and Subcircuit

PSpice and *Parts* are trademarks of MicroSim Corporation.



POST OFFICE BOX 655303 • DALLAS, TEXAS 75265

PACKAGING INFORMATION

Orderable Device	Status (1)	Package Type	Package Drawing	Pins	Package Qty	Eco Plan (2)	Lead/Ball Finish (6)	MSL Peak Temp (3)	Op Temp (°C)	Device Marking (4/5)	Samples
TLE2071AQDRG4Q1	ACTIVE	SOIC	D	8	2500	Green (RoHS & no Sb/Br)	CU NIPDAU	Level-1-260C-UNLIM	-40 to 125	2071AQ	Samples
TLE2071AQDRQ1	ACTIVE	SOIC	D	8	2500	Green (RoHS & no Sb/Br)	CU NIPDAU	Level-1-260C-UNLIM	-40 to 125	2071AQ	Samples
TLE2072AQDRG4Q1	ACTIVE	SOIC	D	8	2500	Green (RoHS & no Sb/Br)	CU NIPDAU	Level-1-260C-UNLIM	-40 to 125	2072AQ	Samples

(1) The marketing status values are defined as follows:

ACTIVE: Product device recommended for new designs.

LIFEBUY: TI has announced that the device will be discontinued, and a lifetime-buy period is in effect.

NRND: Not recommended for new designs. Device is in production to support existing customers, but TI does not recommend using this part in a new design.

PREVIEW: Device has been announced but is not in production. Samples may or may not be available.

OBSOLETE: TI has discontinued the production of the device.

(2) Eco Plan - The planned eco-friendly classification: Pb-Free (RoHS), Pb-Free (RoHS Exempt), or Green (RoHS & no Sb/Br) - please check <http://www.ti.com/productcontent> for the latest availability information and additional product content details.

TBD: The Pb-Free/Green conversion plan has not been defined.

Pb-Free (RoHS): TI's terms "Lead-Free" or "Pb-Free" mean semiconductor products that are compatible with the current RoHS requirements for all 6 substances, including the requirement that lead not exceed 0.1% by weight in homogeneous materials. Where designed to be soldered at high temperatures, TI Pb-Free products are suitable for use in specified lead-free processes.

Pb-Free (RoHS Exempt): This component has a RoHS exemption for either 1) lead-based flip-chip solder bumps used between the die and package, or 2) lead-based die adhesive used between the die and leadframe. The component is otherwise considered Pb-Free (RoHS compatible) as defined above.

Green (RoHS & no Sb/Br): TI defines "Green" to mean Pb-Free (RoHS compatible), and free of Bromine (Br) and Antimony (Sb) based flame retardants (Br or Sb do not exceed 0.1% by weight in homogeneous material)

(3) MSL, Peak Temp. - The Moisture Sensitivity Level rating according to the JEDEC industry standard classifications, and peak solder temperature.

(4) There may be additional marking, which relates to the logo, the lot trace code information, or the environmental category on the device.

(5) Multiple Device Markings will be inside parentheses. Only one Device Marking contained in parentheses and separated by a "~" will appear on a device. If a line is indented then it is a continuation of the previous line and the two combined represent the entire Device Marking for that device.

(6) Lead/Ball Finish - Orderable Devices may have multiple material finish options. Finish options are separated by a vertical ruled line. Lead/Ball Finish values may wrap to two lines if the finish value exceeds the maximum column width.

Important Information and Disclaimer: The information provided on this page represents TI's knowledge and belief as of the date that it is provided. TI bases its knowledge and belief on information provided by third parties, and makes no representation or warranty as to the accuracy of such information. Efforts are underway to better integrate information from third parties. TI has taken and

continues to take reasonable steps to provide representative and accurate information but may not have conducted destructive testing or chemical analysis on incoming materials and chemicals. TI and TI suppliers consider certain information to be proprietary, and thus CAS numbers and other limited information may not be available for release.

In no event shall TI's liability arising out of such information exceed the total purchase price of the TI part(s) at issue in this document sold by TI to Customer on an annual basis.

OTHER QUALIFIED VERSIONS OF TLE2071A-Q1, TLE2072A-Q1 :

- Catalog: [TLE2071A](#), [TLE2072A](#)
- Military: [TLE2071AM](#), [TLE2072AM](#)



NOTE: Qualified Version Definitions:

- Catalog - TI's standard catalog product
- Military - QML certified for Military and Defense Applications

D (R-PDSO-G8)

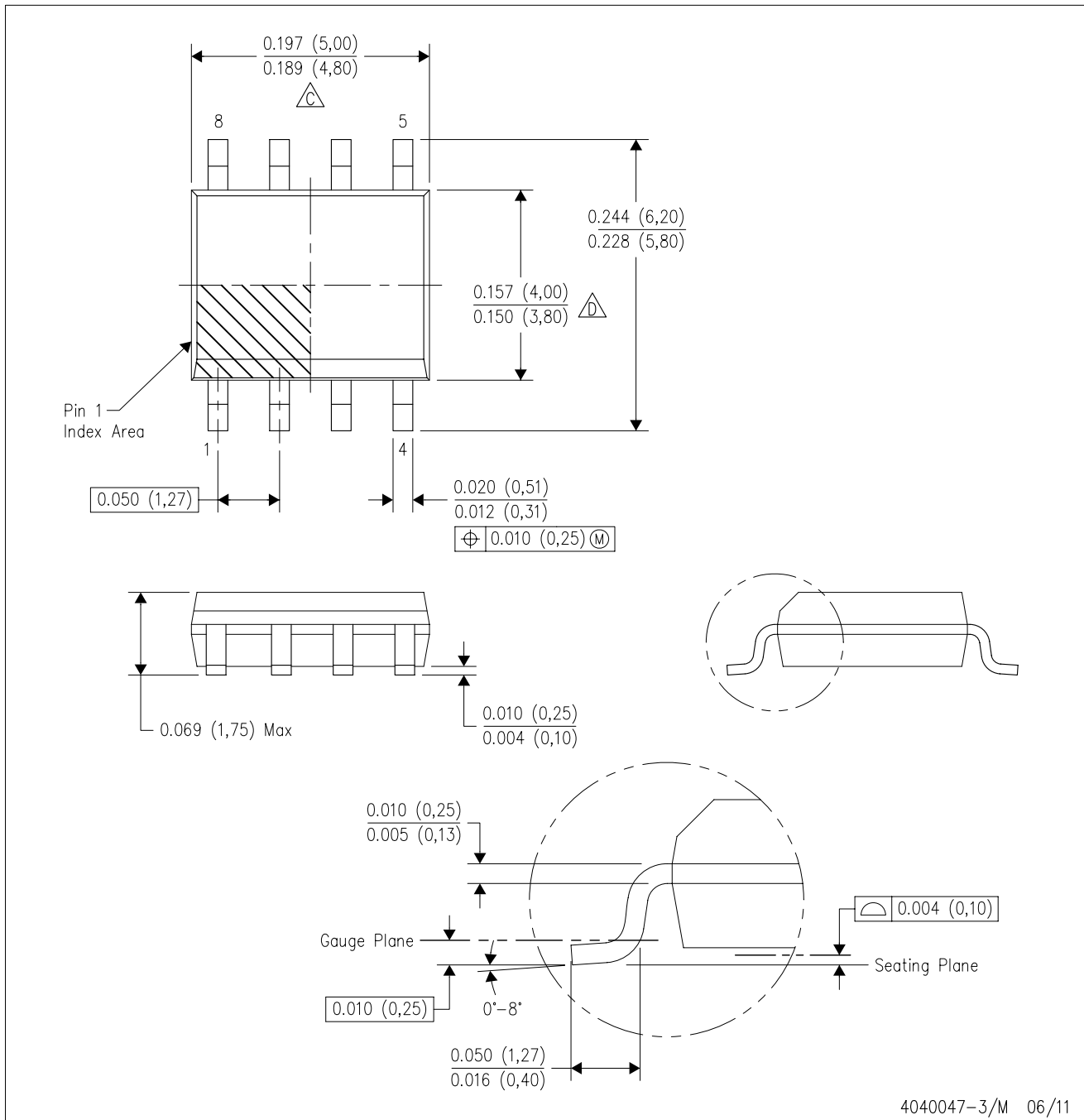
PLASTIC SMALL OUTLINE



- NOTES:
- A. All linear dimensions are in inches (millimeters).
 - B. This drawing is subject to change without notice.
 -  Body length does not include mold flash, protrusions, or gate burrs. Mold flash, protrusions, or gate burrs shall not exceed 0.006 (0,15) each side.
 -  Body width does not include interlead flash. Interlead flash shall not exceed 0.017 (0,43) each side.
 - E. Reference JEDEC MS-012 variation AA.

D (R-PDSO-G8)

PLASTIC SMALL OUTLINE

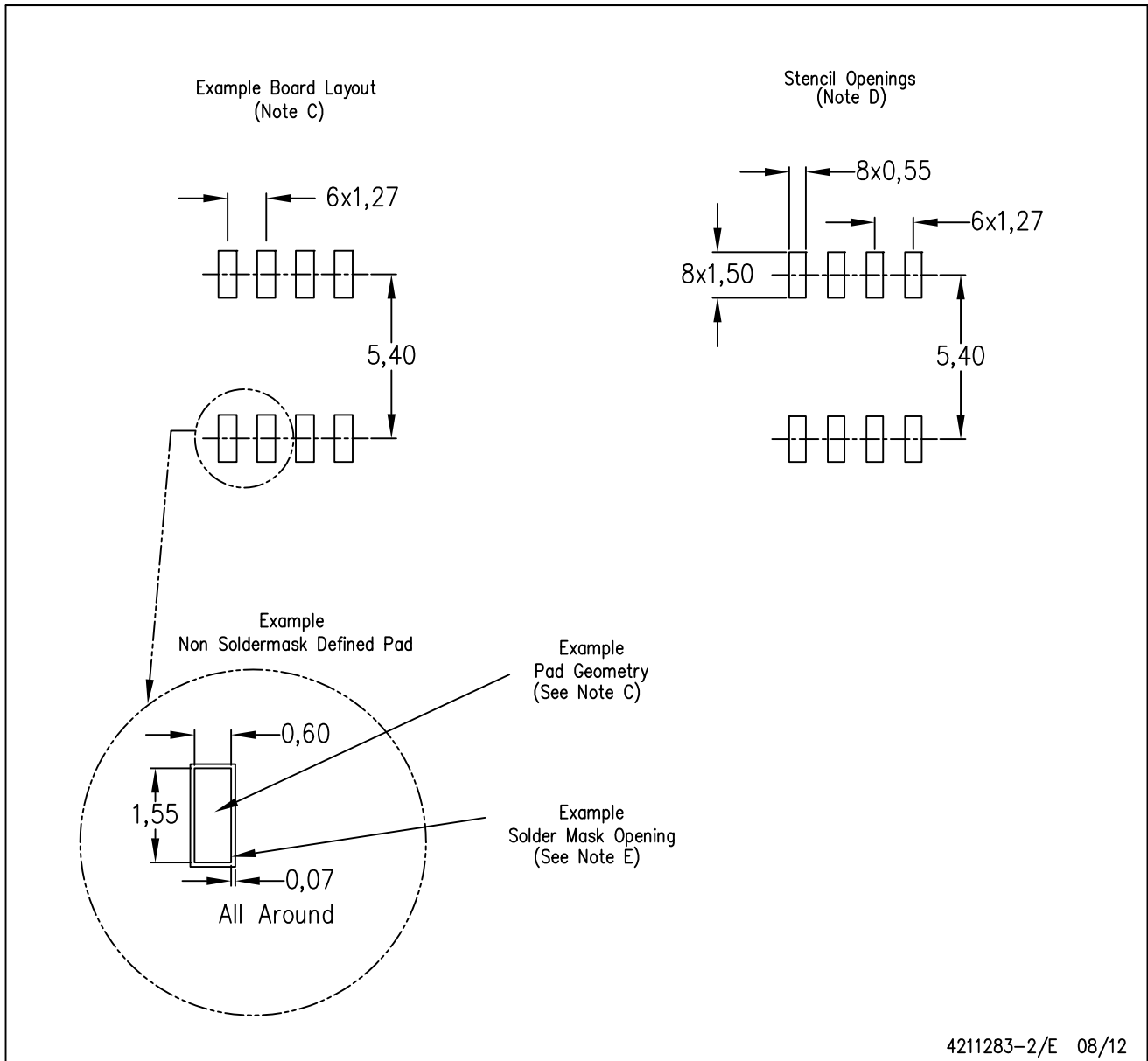

- NOTES:
- All linear dimensions are in millimeters.
 - This drawing is subject to change without notice.
 - Publication IPC-7351 is recommended for alternate designs.
 - Laser cutting apertures with trapezoidal walls and also rounding corners will offer better paste release. Customers should contact their board assembly site for stencil design recommendations. Refer to IPC-7525 for other stencil recommendations.
 - Customers should contact their board fabrication site for solder mask tolerances between and around signal pads.

IMPORTANT NOTICE

Texas Instruments Incorporated (TI) reserves the right to make corrections, enhancements, improvements and other changes to its semiconductor products and services per JESD46, latest issue, and to discontinue any product or service per JESD48, latest issue. Buyers should obtain the latest relevant information before placing orders and should verify that such information is current and complete.

TI's published terms of sale for semiconductor products (<http://www.ti.com/sc/docs/stdterms.htm>) apply to the sale of packaged integrated circuit products that TI has qualified and released to market. Additional terms may apply to the use or sale of other types of TI products and services.

Reproduction of significant portions of TI information in TI data sheets is permissible only if reproduction is without alteration and is accompanied by all associated warranties, conditions, limitations, and notices. TI is not responsible or liable for such reproduced documentation. Information of third parties may be subject to additional restrictions. Resale of TI products or services with statements different from or beyond the parameters stated by TI for that product or service voids all express and any implied warranties for the associated TI product or service and is an unfair and deceptive business practice. TI is not responsible or liable for any such statements.

Buyers and others who are developing systems that incorporate TI products (collectively, "Designers") understand and agree that Designers remain responsible for using their independent analysis, evaluation and judgment in designing their applications and that Designers have full and exclusive responsibility to assure the safety of Designers' applications and compliance of their applications (and of all TI products used in or for Designers' applications) with all applicable regulations, laws and other applicable requirements. Designer represents that, with respect to their applications, Designer has all the necessary expertise to create and implement safeguards that (1) anticipate dangerous consequences of failures, (2) monitor failures and their consequences, and (3) lessen the likelihood of failures that might cause harm and take appropriate actions. Designer agrees that prior to using or distributing any applications that include TI products, Designer will thoroughly test such applications and the functionality of such TI products as used in such applications.

TI's provision of technical, application or other design advice, quality characterization, reliability data or other services or information, including, but not limited to, reference designs and materials relating to evaluation modules, (collectively, "TI Resources") are intended to assist designers who are developing applications that incorporate TI products; by downloading, accessing or using TI Resources in any way, Designer (individually or, if Designer is acting on behalf of a company, Designer's company) agrees to use any particular TI Resource solely for this purpose and subject to the terms of this Notice.

TI's provision of TI Resources does not expand or otherwise alter TI's applicable published warranties or warranty disclaimers for TI products, and no additional obligations or liabilities arise from TI providing such TI Resources. TI reserves the right to make corrections, enhancements, improvements and other changes to its TI Resources. TI has not conducted any testing other than that specifically described in the published documentation for a particular TI Resource.

Designer is authorized to use, copy and modify any individual TI Resource only in connection with the development of applications that include the TI product(s) identified in such TI Resource. NO OTHER LICENSE, EXPRESS OR IMPLIED, BY ESTOPPEL OR OTHERWISE TO ANY OTHER TI INTELLECTUAL PROPERTY RIGHT, AND NO LICENSE TO ANY TECHNOLOGY OR INTELLECTUAL PROPERTY RIGHT OF TI OR ANY THIRD PARTY IS GRANTED HEREIN, including but not limited to any patent right, copyright, mask work right, or other intellectual property right relating to any combination, machine, or process in which TI products or services are used. Information regarding or referencing third-party products or services does not constitute a license to use such products or services, or a warranty or endorsement thereof. Use of TI Resources may require a license from a third party under the patents or other intellectual property of the third party, or a license from TI under the patents or other intellectual property of TI.

TI RESOURCES ARE PROVIDED "AS IS" AND WITH ALL FAULTS. TI DISCLAIMS ALL OTHER WARRANTIES OR REPRESENTATIONS, EXPRESS OR IMPLIED, REGARDING RESOURCES OR USE THEREOF, INCLUDING BUT NOT LIMITED TO ACCURACY OR COMPLETENESS, TITLE, ANY EPIDEMIC FAILURE WARRANTY AND ANY IMPLIED WARRANTIES OF MERCHANTABILITY, FITNESS FOR A PARTICULAR PURPOSE, AND NON-INFRINGEMENT OF ANY THIRD PARTY INTELLECTUAL PROPERTY RIGHTS. TI SHALL NOT BE LIABLE FOR AND SHALL NOT DEFEND OR INDEMNIFY DESIGNER AGAINST ANY CLAIM, INCLUDING BUT NOT LIMITED TO ANY INFRINGEMENT CLAIM THAT RELATES TO OR IS BASED ON ANY COMBINATION OF PRODUCTS EVEN IF DESCRIBED IN TI RESOURCES OR OTHERWISE. IN NO EVENT SHALL TI BE LIABLE FOR ANY ACTUAL, DIRECT, SPECIAL, COLLATERAL, INDIRECT, PUNITIVE, INCIDENTAL, CONSEQUENTIAL OR EXEMPLARY DAMAGES IN CONNECTION WITH OR ARISING OUT OF TI RESOURCES OR USE THEREOF, AND REGARDLESS OF WHETHER TI HAS BEEN ADVISED OF THE POSSIBILITY OF SUCH DAMAGES.

Unless TI has explicitly designated an individual product as meeting the requirements of a particular industry standard (e.g., ISO/TS 16949 and ISO 26262), TI is not responsible for any failure to meet such industry standard requirements.

Where TI specifically promotes products as facilitating functional safety or as compliant with industry functional safety standards, such products are intended to help enable customers to design and create their own applications that meet applicable functional safety standards and requirements. Using products in an application does not by itself establish any safety features in the application. Designers must ensure compliance with safety-related requirements and standards applicable to their applications. Designer may not use any TI products in life-critical medical equipment unless authorized officers of the parties have executed a special contract specifically governing such use. Life-critical medical equipment is medical equipment where failure of such equipment would cause serious bodily injury or death (e.g., life support, pacemakers, defibrillators, heart pumps, neurostimulators, and implantables). Such equipment includes, without limitation, all medical devices identified by the U.S. Food and Drug Administration as Class III devices and equivalent classifications outside the U.S.

TI may expressly designate certain products as completing a particular qualification (e.g., Q100, Military Grade, or Enhanced Product). Designers agree that it has the necessary expertise to select the product with the appropriate qualification designation for their applications and that proper product selection is at Designers' own risk. Designers are solely responsible for compliance with all legal and regulatory requirements in connection with such selection.

Designer will fully indemnify TI and its representatives against any damages, costs, losses, and/or liabilities arising out of Designer's non-compliance with the terms and provisions of this Notice.