



TIP110/112 TIP115/117

COMPLEMENTARY SILICON POWER DARLINGTON TRANSISTORS

- STMicroelectronics PREFERRED SALESTYPES
- COMPLEMENTARY PNP - NPN DEVICES
- MONOLITHIC DARLINGTON CONFIGURATION
- INTEGRATED ANTIPARALLEL COLLECTOR-EMITTER DIODE

APPLICATIONS

- LINEAR AND SWITCHING INDUSTRIAL EQUIPMENT

DESCRIPTION

The TIP110 and TIP112 are silicon Epitaxial-Base NPN transistors in monolithic Darlington configuration mounted in Jedec TO-220 plastic package. They are intended for use in medium power linear and switching applications.

The complementary PNP types are TIP115 and TIP117.

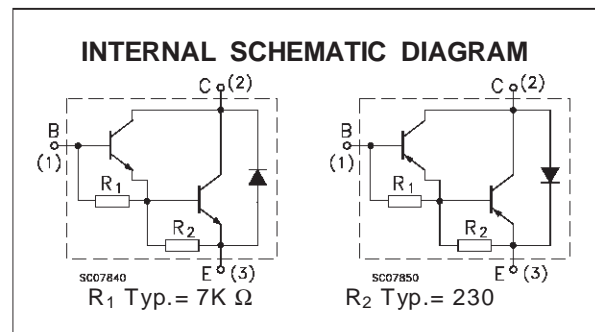
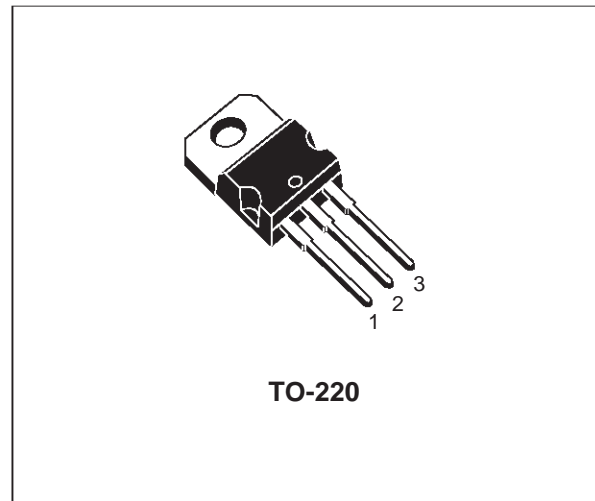

ABSOLUTE MAXIMUM RATINGS

Symbol	Parameter	Value		Unit	
		NPN	TIP110		TIP112
		PNP	TIP115		TIP117
V _{CBO}	Collector-Base Voltage (I _E = 0)		60	100	V
V _{CEO}	Collector-Emitter Voltage (I _B = 0)		60	100	V
V _{EBO}	Emitter-Base Voltage (I _C = 0)		5		V
I _C	Collector Current		2		A
I _{CM}	Collector Peak Current		4		A
I _B	Base Current		50		mA
P _{tot}	Total Dissipation at T _{case} ≤ 25 °C T _{amb} ≤ 25 °C		50		W
			2		W
T _{stg}	Storage Temperature		-65 to 150		°C
T _j	Max. Operating Junction Temperature		150		°C

* For PNP types voltage and current values are negative

TIP110/TIP112/TIP115/TIP117

THERMAL DATA

R _{thj-case}	Thermal Resistance Junction-case	Max	2.5	°C/W
R _{thj-amb}	Thermal Resistance Junction-ambient	Max	62.5	°C/W

ELECTRICAL CHARACTERISTICS (T_{case} = 25 °C unless otherwise specified)

Symbol	Parameter	Test Conditions	Min.	Typ.	Max.	Unit
I _{CEO}	Collector Cut-off Current (I _B = 0)	V _{CE} = Half Rated V _{CEO}			2	mA
I _{CBO}	Collector Cut-off Current (I _E = 0)	V _{CB} = Rated V _{CBO}			1	mA
I _{EBO}	Emitter Cut-off Current (I _C = 0)	V _{EB} = 5 V			2	mA
V _{CEO(sus)*}	Collector-Emitter Sustaining Voltage (I _B = 0)	I _C = 30 mA for TIP110/115 for TIP112/117	60 100			V V
V _{CE(sat)*}	Collector-Emitter Saturation Voltage	I _C = 2 A I _B = 8 mA			2.5	V
V _{BE*}	Base-Emitter Voltage	I _C = 2 A V _{CE} = 4 V			2.8	V
h _{FE*}	DC Current Gain	I _C = 1 A V _{CE} = 4 V I _C = 2 A V _{CE} = 4 V	1000 500			

* Pulsed: Pulse duration = 300 μs, duty cycle 1.5 %
For PNP types voltage and current values are negative.

Safe Operating Areas

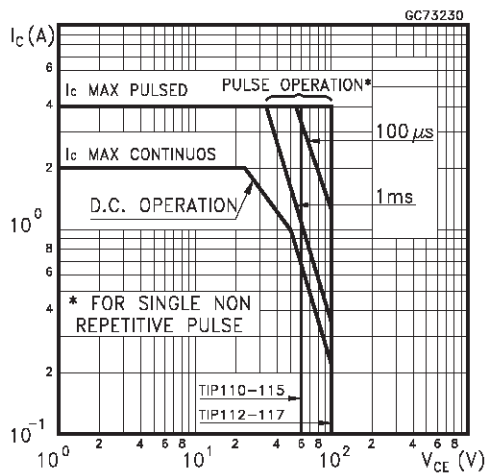

Derating Curve

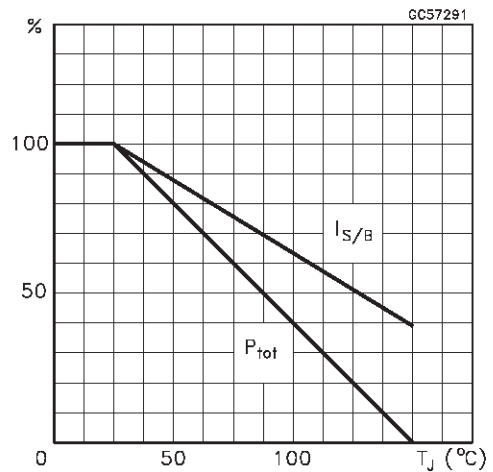

DC Current Gain (NPN type)

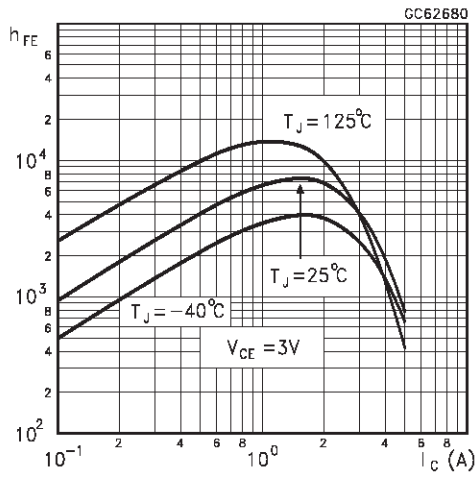

DC Current Gain (PNP type)

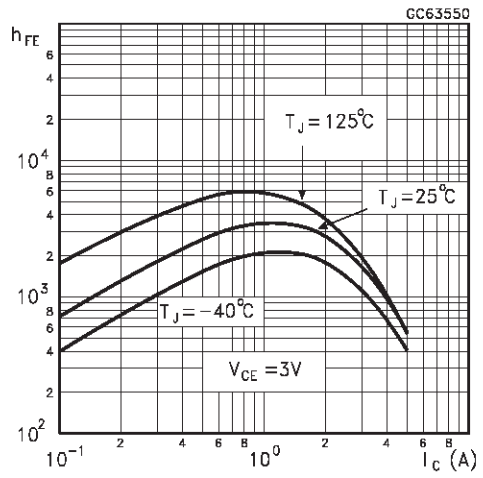

Collector-Emitter Saturation Voltage (NPN type)

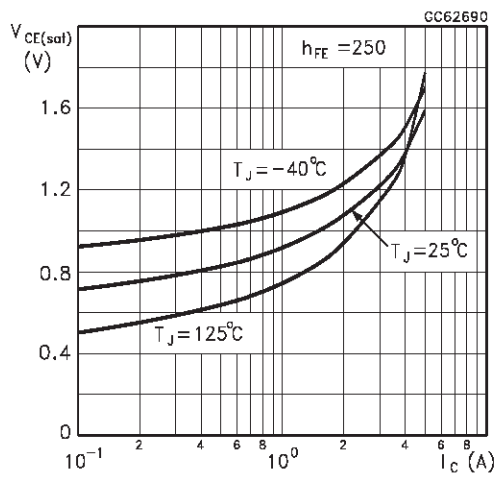

Collector-Emitter Saturation Voltage (PNP type)

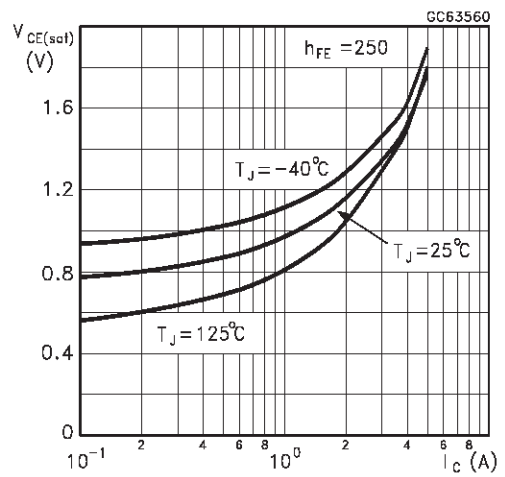

Base-Emitter Saturation Voltage (NPN type)

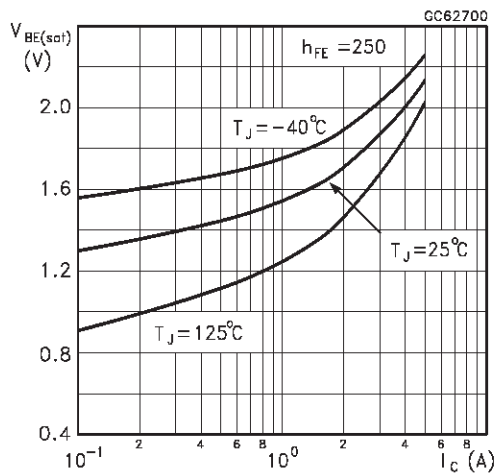

Base-Emitter Saturation Voltage (PNP type)

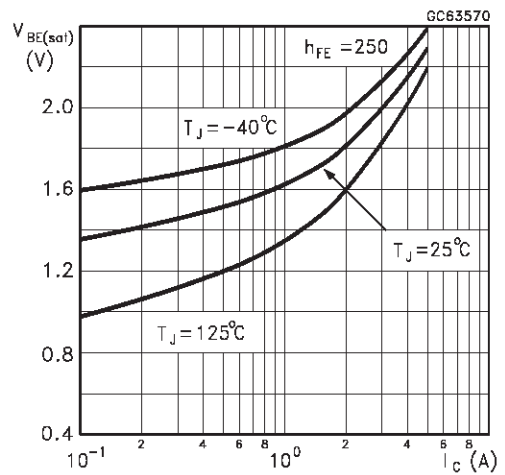

Base-Emitter On Voltage (NPN type)

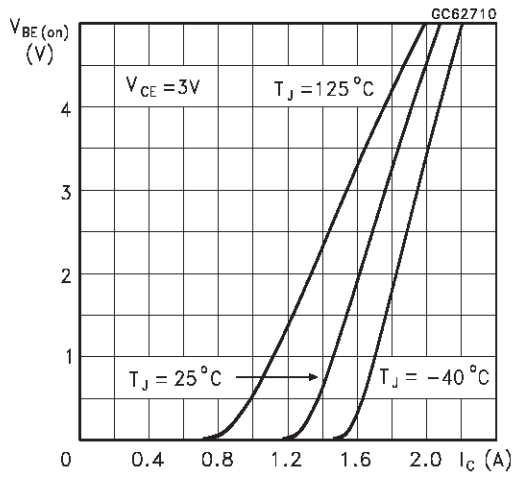

Base-Emitter On Voltage (PNP type)

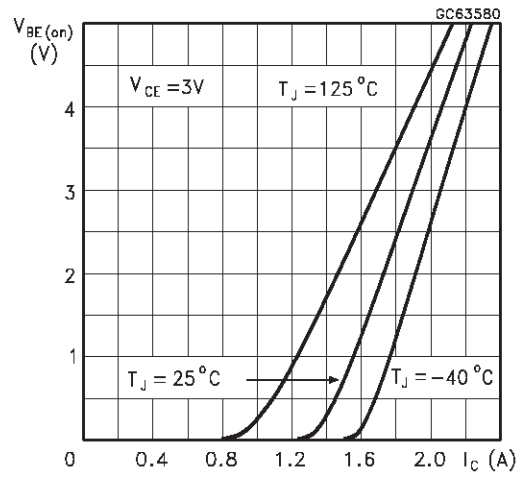

Freewheel Diode Forward Voltage (NPN types)

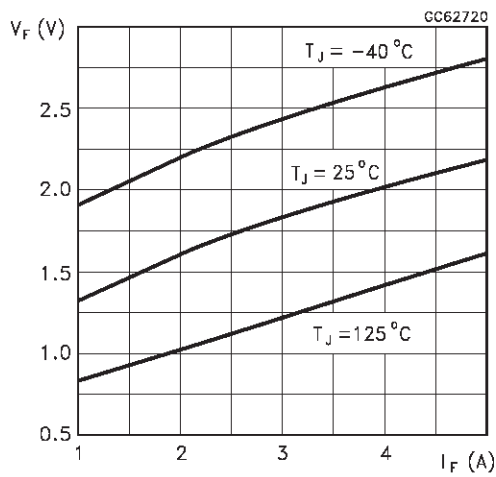

Freewheel Diode Forward Voltage (PNP types)

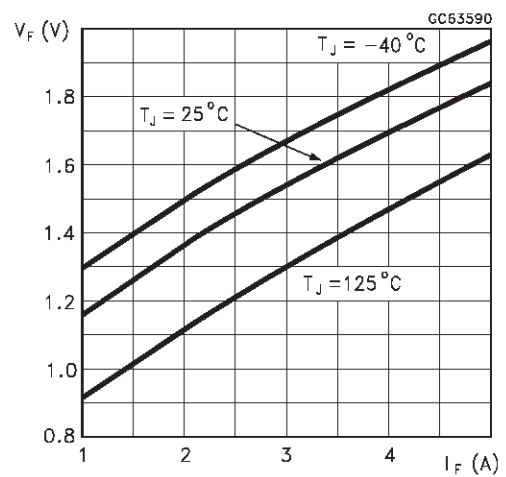

TO-220 MECHANICAL DATA

DIM.	mm			inch		
	MIN.	TYP.	MAX.	MIN.	TYP.	MAX.
A	4.40		4.60	0.173		0.181
C	1.23		1.32	0.048		0.051
D	2.40		2.72	0.094		0.107
D1		1.27			0.050	
E	0.49		0.70	0.019		0.027
F	0.61		0.88	0.024		0.034
F1	1.14		1.70	0.044		0.067
F2	1.14		1.70	0.044		0.067
G	4.95		5.15	0.194		0.203
G1	2.4		2.7	0.094		0.106
H2	10.0		10.40	0.393		0.409
L2		16.4			0.645	
L4	13.0		14.0	0.511		0.551
L5	2.65		2.95	0.104		0.116
L6	15.25		15.75	0.600		0.620
L7	6.2		6.6	0.244		0.260
L9	3.5		3.93	0.137		0.154
DIA.	3.75		3.85	0.147		0.151

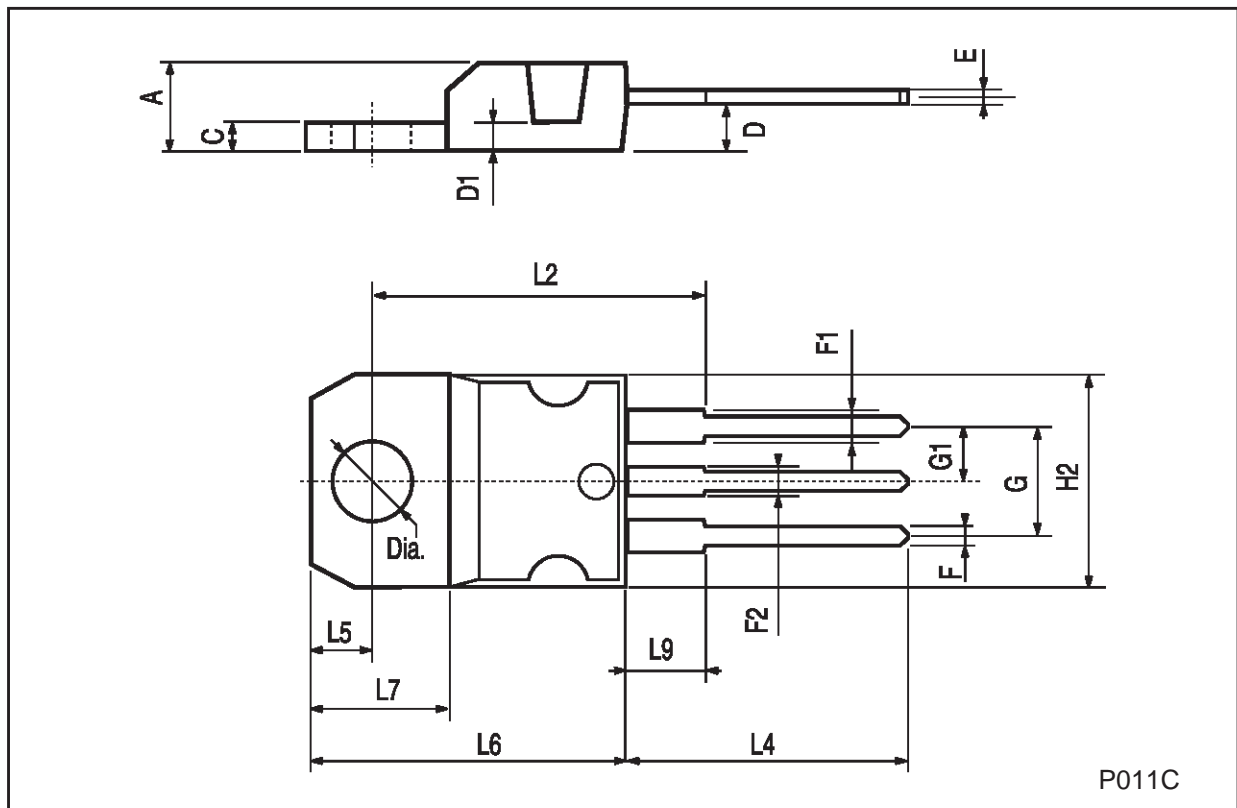

P011C

Information furnished is believed to be accurate and reliable. However, STMicroelectronics assumes no responsibility for the consequences of use of such information nor for any infringement of patents or other rights of third parties which may result from its use. No license is granted by implication or otherwise under any patent or patent rights of STMicroelectronics. Specification mentioned in this publication are subject to change without notice. This publication supersedes and replaces all information previously supplied. STMicroelectronics products are not authorized for use as critical components in life support devices or systems without express written approval of STMicroelectronics.

The ST logo is a trademark of STMicroelectronics

© 1999 STMicroelectronics – Printed in Italy – All Rights Reserved

STMicroelectronics GROUP OF COMPANIES

Australia - Brazil - Canada - China - France - Germany - Italy - Japan - Korea - Malaysia - Malta - Mexico - Morocco - The Netherlands - Singapore - Spain - Sweden - Switzerland - Taiwan - Thailand - United Kingdom - U.S.A.

<http://www.st.com>