

TOSHIBA CMOS DIGITAL INTEGRATED CIRCUIT SILICON MONOLITHIC

TC7SZ125F, TC7SZ125FU

BUS BUFFER 3-STATE OUTPUT

FEATURES

- High Output Drive : ± 24 mA (Typ.)
($V_{CC} = 3$ V)
- Super High Speed Operation : $t_{pD} = 2.6$ ns (Typ.)
($V_{CC} = 5$ V, 50 pF)
- Operation Voltage Range : $V_{CC(opr)} = 1.8 \sim 5.5$ V
- Supply Voltage Data Retention : $V_{CC} = 1.5 \sim 5.5$ V
- 5 V Tolerant Function
- Matches the Performance of TC74LCX Series when Operated at 3.3 V V_{CC}

MAXIMUM RATINGS (Ta = 25°C)

CHARACTERISTIC	SYMBOL	RATING	UNIT
Supply Voltage Range	V_{CC}	-0.5~6	V
DC Input Voltage	V_{IN}	-0.5~6	V
DC Output Voltage	V_{OUT}	-0.5~6	V
Input Diode Current	I_{IK}	± 20	mA
Output Diode Current	I_{OK}	± 20	mA
DC Output Current	I_{OUT}	± 50	mA
DC V_{CC} /Ground Current	I_{CC}	± 50	mA
Power Dissipation	P_D	200	mW
Storage Temperature	T_{stg}	-65~150	°C
Lead Temperature (10 s)	T_L	260	°C

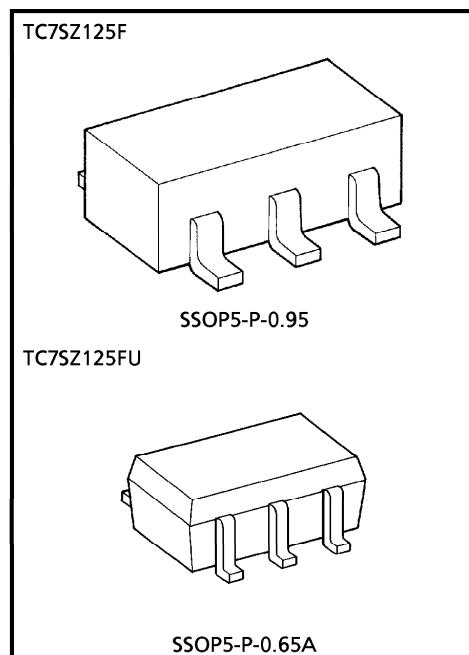

Weight
 SSOP5-P-0.95 : 0.016 g (Typ.)
 SSOP5-P-0.65A : 0.006 g (Typ.)

980910EBA1

- TOSHIBA is continually working to improve the quality and the reliability of its products. Nevertheless, semiconductor devices in general can malfunction or fail due to their inherent electrical sensitivity and vulnerability to physical stress. It is the responsibility of the buyer, when utilizing TOSHIBA products, to observe standards of safety, and to avoid situations in which a malfunction or failure of a TOSHIBA product could cause loss of human life, bodily injury or damage to property. In developing your designs, please ensure that TOSHIBA products are used within specified operating ranges as set forth in the most recent products specifications. Also, please keep in mind the precautions and conditions set forth in the TOSHIBA Semiconductor Reliability Handbook.
- The products described in this document are subject to the foreign exchange and foreign trade laws.
- The information contained herein is presented only as a guide for the applications of our products. No responsibility is assumed by TOSHIBA CORPORATION for any infringements of intellectual property or other rights of the third parties which may result from its use. No license is granted by implication or otherwise under any intellectual property or other rights of TOSHIBA CORPORATION or others.
- The information contained herein is subject to change without notice.

DC ELECTRICAL CHARACTERISTICS

CHARACTERISTIC	SYMBOL	TEST CONDITION	V _{CC} (V)	Ta = 25°C			Ta = -40~85°C		UNIT		
				MIN.	TYP.	MAX.	MIN.	MAX.			
High-Level Input Voltage	V _{IH}		1.8	0.88 × V _{CC}	—	—	0.88 × V _{CC}	—	V		
			2.3~ 5.5	0.75 × V _{CC}	—	—	0.75 × V _{CC}	—			
Low-Level Input Voltage	V _{IL}		1.8	—	—	0.12 × V _{CC}	—	0.12 × V _{CC}	V		
			2.3~ 5.5	—	—	0.25 × V _{CC}	—	0.25 × V _{CC}			
High-Level Output Voltage	V _{OH}	V _{IN} = V _{IH}	I _{OH} = -100 μA	1.8	1.7	1.8	—	1.7	—	V	
				2.3	2.2	2.3	—	2.2	—		
				3.0	2.9	3.0	—	2.9	—		
				4.5	4.4	4.5	—	4.4	—		
				I _{OH} = -8 mA	2.3	1.9	2.15	—	1.9		—
				I _{OH} = -16 mA	3.0	2.4	2.8	—	2.4		—
				I _{OH} = -24 mA	3.0	2.3	2.68	—	2.3		—
I _{OH} = -32 mA	4.5	3.8	4.2	—	3.8	—					
Low-Level Output Voltage	V _{OL}	V _{IN} = V _{IL}	I _{OL} = 100 μA	1.8	—	0	0.1	—	0.1	V	
				2.3	—	0	0.1	—	0.1		
				3.0	—	0	0.1	—	0.1		
				4.5	—	0	0.1	—	0.1		
				I _{OL} = 8 mA	2.3	—	0.1	0.3	—		0.3
				I _{OL} = 16 mA	3.0	—	0.15	0.4	—		0.4
				I _{OL} = 24 mA	3.0	—	0.22	0.55	—		0.55
I _{OL} = 32 mA	4.5	—	0.22	0.55	—	0.55					
Input Leakage Current	I _{IN}	V _{IN} = 5.5 V or GND	0~ 5.5	—	—	±1	—	±10	μA		
Power Off Leakage Current	I _{OFF}	V _{IN} or V _{OUT} = 5.5 V	0.0	—	—	1	—	10	μA		
Quiescent Supply Current	I _{CC}	V _{IN} = V _{CC} or GND	5.5	—	—	2	—	20	μA		

AC ELECTRICAL CHARACTERISTICS (Input $t_r = t_f = 3$ ns)

CHARACTERISTIC	SYMBOL	TEST CONDITION	Ta = 25°C			Ta = -40~85°C		UNIT	
			V _{CC} (V)	MIN.	TYP.	MAX.	MIN.		MAX.
Propagation Delay Time	t _{PLH} t _{PHL}	C _L = 15 pF, R _L = 1 MΩ (Figure 1)	1.8	2.0	5.3	11.0	2.0	11.5	ns
			2.5 ± 0.2	0.8	3.4	7.5	0.8	8.0	
			3.3 ± 0.3	0.5	2.5	5.2	0.5	5.5	
			5.0 ± 0.5	0.5	2.1	4.5	0.5	4.8	
		C _L = 50 pF, R _L = 500 Ω (Figure 1)	3.3 ± 0.3	1.5	3.2	5.7	1.5	6.0	
			5.0 ± 0.5	0.8	2.6	5.0	0.8	5.3	
Output Enable Time	t _{PZL} t _{PZH}	C _L = 50 pF, R _L = 500 Ω (Figure 1)	1.8	2.0	7.0	12.5	2.0	13.0	ns
			2.5 ± 0.2	1.5	4.6	8.5	1.5	9.0	
			3.3 ± 0.3	1.5	3.5	6.2	1.5	6.5	
			5.0 ± 0.5	0.8	2.8	5.5	0.8	5.8	
Output Disable Time	t _{PLZ} t _{PHZ}	C _L = 50 pF, R _L = 500 Ω (Figure 1)	1.8	2.0	5.4	11.0	2.0	12.0	ns
			2.5 ± 0.2	1.5	3.5	8.0	1.5	8.5	
			3.3 ± 0.3	1.0	2.8	5.7	1.0	6.0	
			5.0 ± 0.5	0.5	2.1	4.7	0.5	5.0	
Input Capacitance	C _{IN}		0~5.5	—	4	—	—	pF	
Power Dissipation Capacitance	C _{PD}	(Note 1)	3.3	—	17	—	—	—	pF
			5.5	—	24	—	—	—	

(Note 1) C_{PD} is defined as the value of the internal equivalent capacitance which is calculated from the operating current consumption without load.

Average operating current can be obtained by the equation.

$$I_{CC(opr)} = C_{PD} \cdot V_{CC} \cdot f_{IN} + I_{CC}$$

Figure 1 AC Characteristics Measurement Circuit

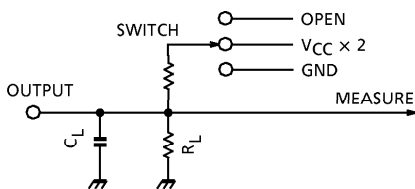

CHARACTERISTICS	SWITCH
t _{PLH} , t _{PHL}	OPEN
t _{PLZ} , t _{PZL}	V _{CC} × 2
t _{PHZ} , t _{PZH}	GND

MARKING

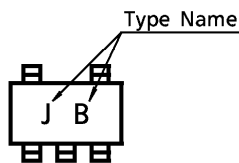

PIN ASSIGNMENT (TOP VIEW)

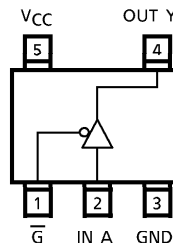

TRUTH TABLE

INPUT		OUTPUT
A	\bar{G}	Y
x	H	Z
L	L	L
H	L	H

x : Don't Care
Z : High Impedance

LOGIC DIAGRAM

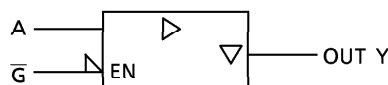

OUTLINE DRAWING
SSOP5-P-0.95

Unit : mm

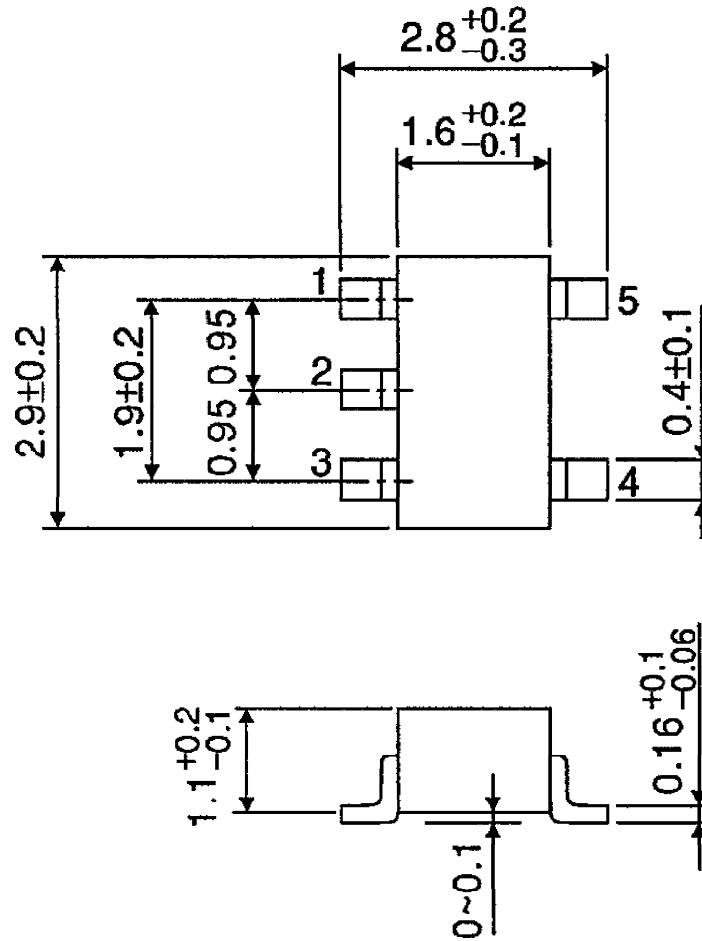

Weight : 0.016 g (Typ.)

OUTLINE DRAWING
SSOP5-P-0.65A

Unit : mm

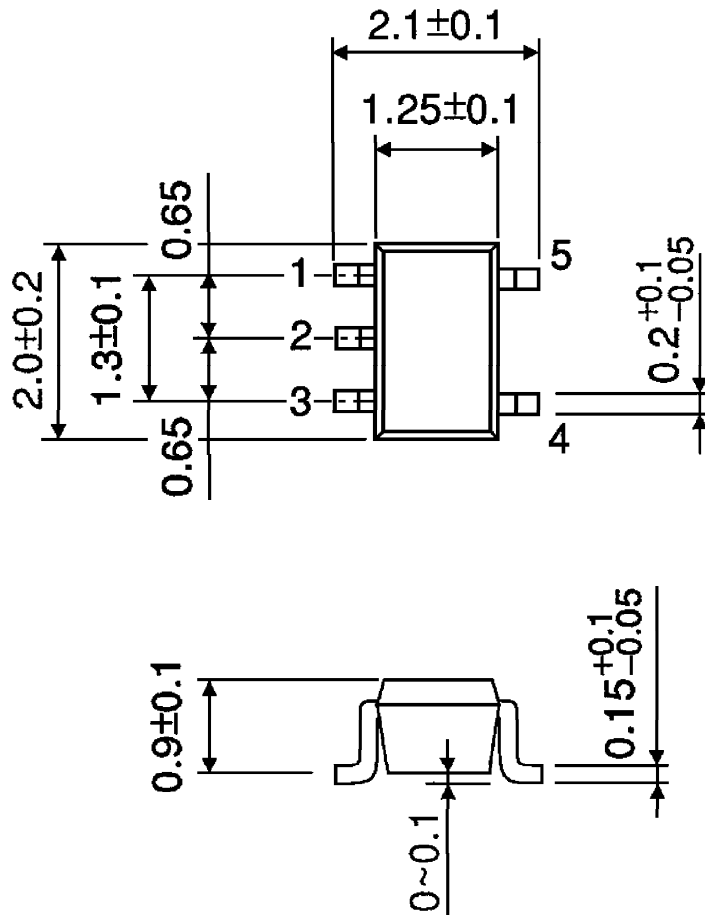

Weight : 0.006 g (Typ.)