

# Transformers for DC-DC Converter C8-R, TR Series

## C8-R4L

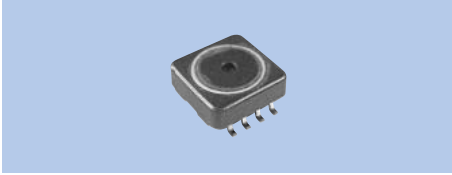

**Specifications**

- (1) -
- (2) 10~500kHz
- (3) 0.8W

**Features**

- SMD
- 1,000pcs./Reel

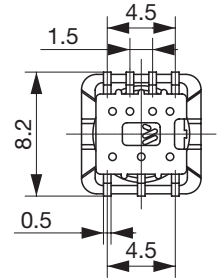
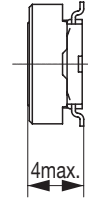
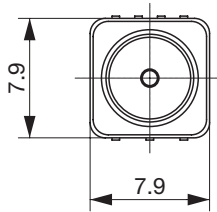

## C8-R5L

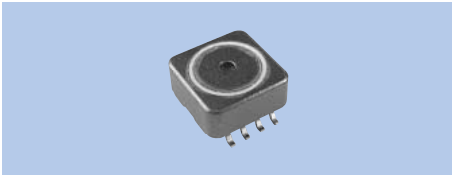

**Specifications**

- (1) -
- (2) 10~500kHz
- (3) 1.0W

**Features**

- SMD
- 1,000pcs./Reel

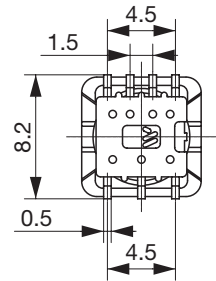
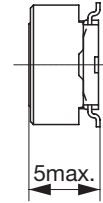
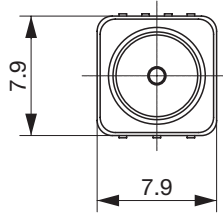

## C8-R6L

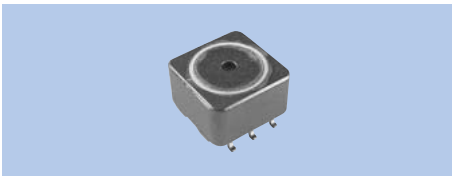

**Specifications**

- (1) -
- (2) 10~500kHz
- (3) 1.2W

**Features**

- SMD
- 1,500pcs./Reel

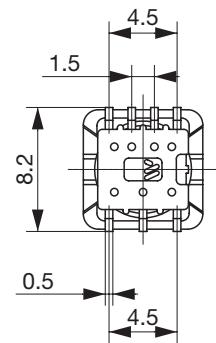
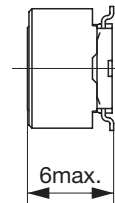
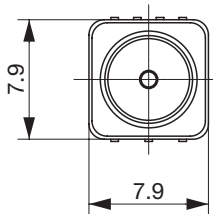

(1) Inductance  
(2) Operational frequency  
(3) Power capacity

TR11-A-S

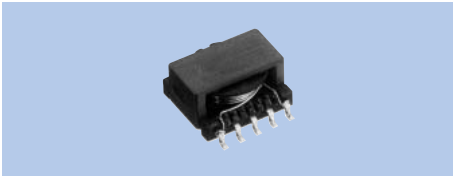

**Specifications**  
 (1) –  
 (2) 10~300kHz  
 (3) 2W

**Features**  
 SMD  
 500pcs./Reel

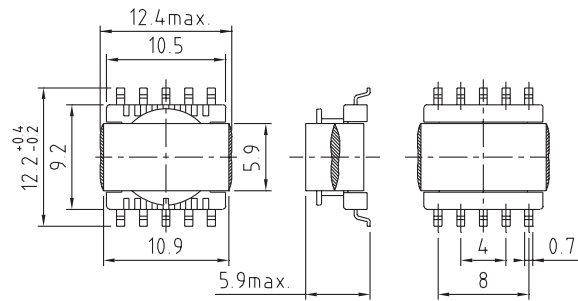

TR14-A-S

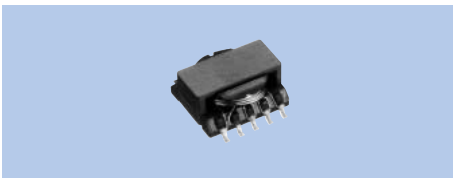

**Specifications**  
 (1) –  
 (2) 10~300kHz  
 (3) 3.0W

**Features**  
 SMD  
 300pcs./Reel

