

# TC40H367P/F

# TC40H368P/F

C<sup>2</sup>MOS DIGITAL INTEGRATED CIRCUIT  
SILICON MONOLITHIC

TC40H367 HEX BUS BUFFER NONINVERTED 3-STATE OUTPUT

TC40H368 HEX BUS BUFFER INVERTED 3-STATE OUTPUT

The TC40H367 and the TC40H368 are hex inverting and non-inverting buffers provided with 3-state output functions. Respective DISABLE inputs for putting outputs in disable conditions are of circuit configuration common in two circuits and four circuits. Therefore, these buffers are suitable for controlling 4-bit data lines.

Further, the output current of each buffer is large, permitting direct drive of then LSTTL input lines.

The TC40H367 and the TC40H368 are compatible in function and pin assignment with the TTL 74LS367 and TTL 74LS368. Further, Toshiba's original product, the TC50L2BP, is the same as the TC40H367.

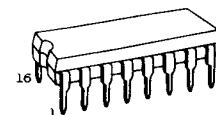

DIP16(3D16A-P)

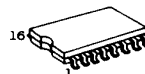

MFP16(F16GC-P)

### MAXIMUM RATINGS

| CHARACTERISTIC      | SYMBOL    | RATING                                     | UNIT               |
|---------------------|-----------|--|--------------------|
| Supply Voltage      | $V_{DD}$  | $V_{SS}-0.5 \sim V_{SS}+10$                | V                  |
| Input Voltage       | $V_{IN}$  | $V_{SS}-0.5 \sim V_{DD}+0.5$               | V                  |
| Output Voltage      | $V_{OUT}$ | $V_{SS}-0.5 \sim V_{DD}+0.5$               | V                  |
| Input Current       | $I_{IN}$  | $\pm 10$                                   | mA                 |
| Power Dissipation   | $P_D$     | 300(DIP)/180(MFP)                          | mW                 |
| Storage Temperature | $T_{stg}$ | $-65 \sim 150$                             | $^{\circ}\text{C}$ |
| Lead Temp./Time     | $T_{sol}$ | $260^{\circ}\text{C} \cdot 10 \text{ sec}$ |                    |

### TRUTH TABLE

TC40H367P

| DISABLE INPUT | INPUT | OUTPUT |
|---------------|-------|--------|
| L             | L     | L      |
| L             | H     | H      |
| H             | *     | HZ     |

TC40H368P

| DISABLE INPUT | INPUT | OUTPUT |
|---------------|-------|--------|
| L             | L     | H      |
| L             | H     | L      |
| H             | *     | HZ     |

HZ=HIGH IMPEDANCE  
\* =Don't care

### PIN CONNECTION

TC40H367

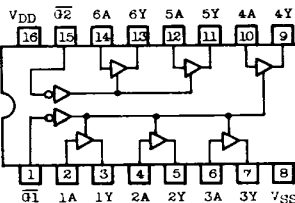

TC40H368

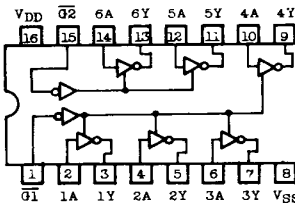

### RECOMMENDED OPERATING CONDITIONS

| CHARACTERISTIC        | SYMBOL    | TEST CONDITION | MIN. | TYP. | MAX.     | UNIT               |
|-----------------------|-----------|----------------|------|------|----------|--------------------|
| Supply Voltage        | $V_{DD}$  |                | 2.0  | -    | 8.0      | V                  |
| Input Voltage         | $V_{IN}$  |                | 0    | -    | $V_{DD}$ | V                  |
| Operating Temperature | $T_{opr}$ |                | -40  | -    | 85       | $^{\circ}\text{C}$ |

**TOSHIBA**

# TC40H367P/F

# TC40H368P/F

## LOGIC DIAGRAM

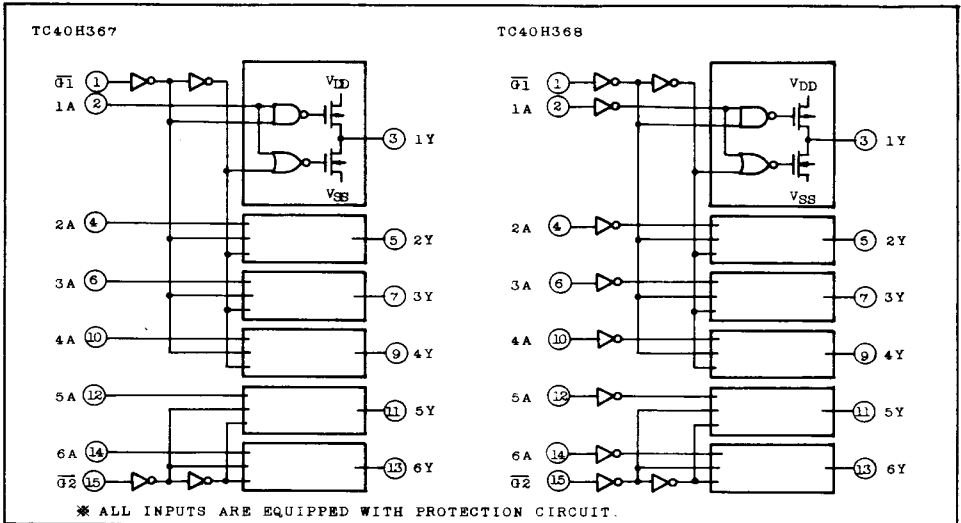
ELECTRICAL CHARACTERISTICS ( $V_{SS}=0V$ )

| CHARACTERISTIC            | SYMBOL    | TEST CONDITION                                  | $V_{DD}$ | -40°C |      | 25°C  |           | 85°C |      | UNIT |         |
|---------------------------|-----------|---|----------|-------|------|-------|-----------|------|------|------|---------|
|                           |           |   |          | MIN.  | MAX. | MIN.  | TYP.      | MAX. | MIN. |      | MAX.    |
| High Level Output Voltage | $V_{OH}$  | $ I_{OUT}  < 1\mu A$<br>$V_{IN}=V_{SS}, V_{DD}$ | 5        | 4.95  | -    | 4.95  | 5.0       | -    | 4.95 | -    | V       |
| Low Level Output Voltage  | $V_{OL}$  | $ I_{OUT}  < 1\mu A$<br>$V_{IN}=V_{SS}, V_{DD}$ | 5        | -     | 0.05 | -     | 0.0       | 0.05 | -    | 0.05 | V       |
| High Level Output Current | $I_{OH}$  | $V_{OUT}=4.6V$<br>$V_{IN}=V_{SS}, V_{DD}$       | 5        | -0.95 | -    | -0.88 | -         | -    | -0.8 | -    | mA      |
| Low Level Output Current  | $I_{OL}$  | $V_{OUT}=0.4V$<br>$V_{IN}=V_{SS}, V_{DD}$       | 5        | 4.7   | -    | 4.4   | -         | -    | 4.0  | -    | mA      |
| Input Voltage             | "H" Level | $V_{IH}$  | 5        | 4.0   | -    | 4.0   | -         | -    | 4.0  | -    | V       |
|                           | "L" Level | $V_{IL}$  |          |       |      |       |           |      |      |      |         |
| Input Current             | "H" Level | $I_{IH}$  | 8        | -     | 0.3  | -     | $10^{-5}$ | 0.3  | -    | 1.0  | $\mu A$ |
|                           | "L" Level | $I_{IL}$  |          |       |      |       |           |      |      |      |         |
| Output Disable Current    | "H" Level | $I_{DH}$  | 8        | -     | 0.5  | -     | $10^{-4}$ | 0.5  | -    | 5    | $\mu A$ |
|                           | "L" Level | $I_{DL}$  |          |       |      |       |           |      |      |      |         |
| Quiescent Supply Current  | $I_{DD}$  | * $V_{IN}=V_{SS}, V_{DD}$                       | 5        | -     | 5.0  | -     | 0.005     | 5.0  | -    | 25   | $\mu A$ |

\*All input valid combinations

# TC40H367P/F

# TC40H368P/F

SWITCHING CHARACTERISTICS ( $T_a=25^\circ\text{C}$ ,  $V_{SS}=0\text{V}$ ,  $V_{DD}=5\text{V}$ ,  $C_L=50\text{pF}$ ,  $R_L=1\text{k}\Omega$ )

| CHARACTERISTIC         | SYMBOL     | TEST CONDITION | TC40H367 |      |      | TC40H368 |      |      | UNIT |
|------------------------|------------|----------------|----------|------|------|----------|------|------|------|
|                        |            |                | MIN.     | TYP. | MAX. | MIN.     | TYP. | MAX. |      |
| Output Rise Time       | $t_{or}$   | Fig.1, 4       | -        | 17   | 35   | -        | 17   | 35   | ns   |
| Output Fall Time       | $t_{of}$   |                | -        | 14   | 30   | -        | 14   | 30   |      |
| Propagation Delay Time | High Level | $t_{pLH}$      | Fig.1, 4 | -    | 20   | 35       | -    | 23   | ns   |
|                        | Low Level  | $t_{pHL}$      |          | -    | 25   | 41       | -    | 27   |      |
| Output Disable Time    | High Level | $t_{pHZ}$      | Fig.3, 6 | -    | 26   | 45       | -    | 26   | ns   |
|                        | Low Level  | $t_{pLZ}$      |          | -    | 26   | 45       | -    | 26   |      |
| Output Enable Time     | High Level | $t_{pZH}$      | Fig.3, 6 | -    | 26   | 45       | -    | 26   | ns   |
|                        | Low Level  | $t_{pZL}$      |          | -    | 30   | 45       | -    | 30   |      |
| Input Capacitance      | $C_{IN}$   |                | -        | 5    | -    | -        | 5    | -    | pF   |
| Output Capacitance     | $C_{OUT}$  |                | -        | 16   | -    | -        | 16   |      |      |

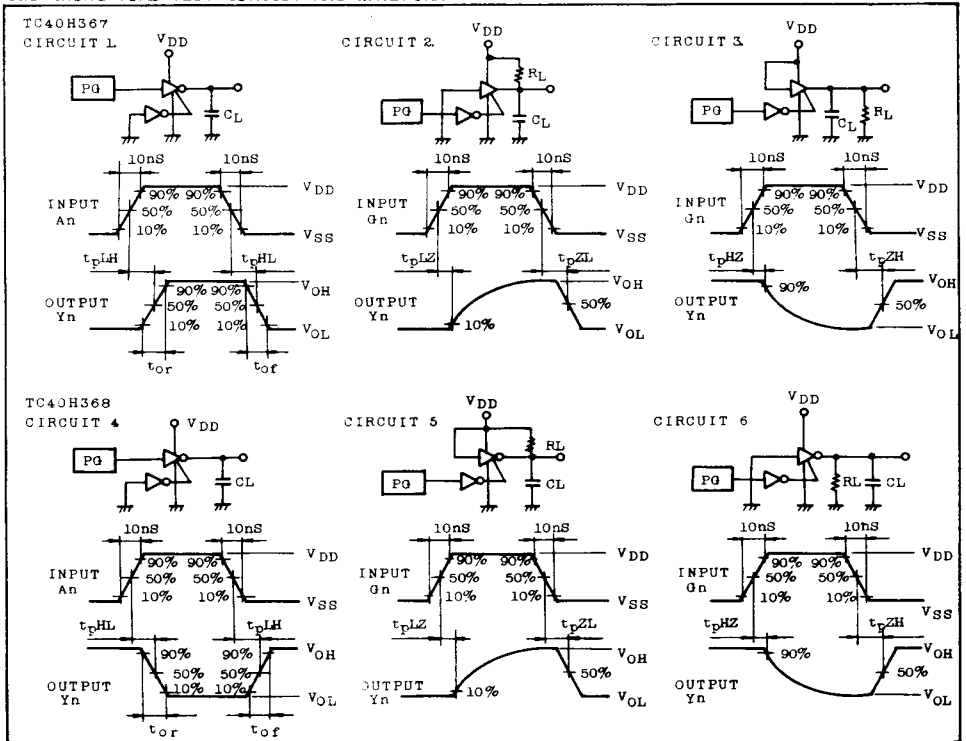
SWITCHING TIME TEST CIRCUIT AND WAVEFORM ( $C_L=50\text{pF}$ ,  $R_L=1\text{k}\Omega$ ,  $f_{IN}=1\text{MHz}$ ,  $t_f=10\text{ns}$ )

# TC40H367P/F

# TC40H368P/F

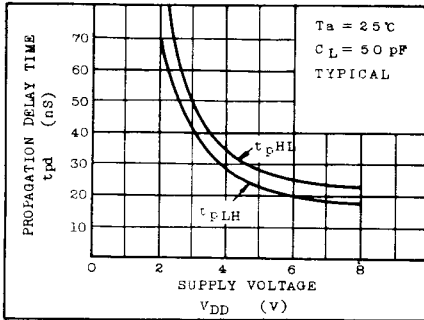
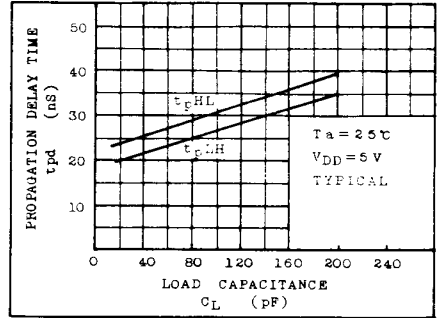
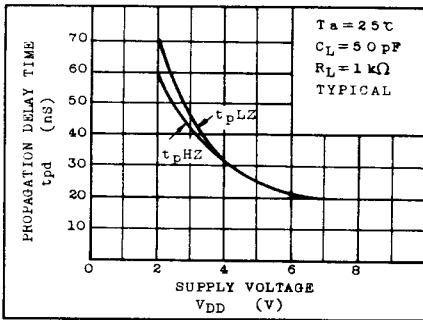
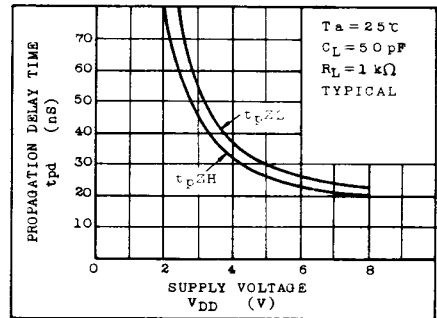
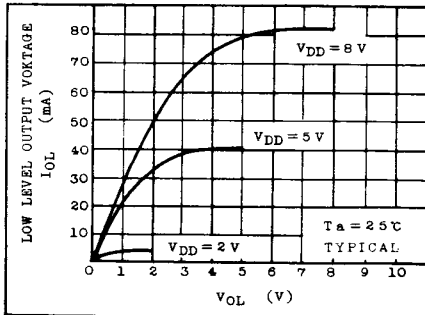
 $t_{pd} - V_{DD}$  $t_{pd} - C_L$  $t_{pd} - V_{DD}$  $t_{pd} - V_{DD}$  $I_{OL} - V_{OL}$  $I_{OH} - (V_{DD} - V_{OH})$ 