

TOSHIBA CMOS DIGITAL INTEGRATED CIRCUIT SILICON MONOLITHIC

T7988, JT7988Y-AS

T7988, JT7988Y-AS SINGLE-CHIP CMOS LSI FOR LCD CALCULATORS

The T7988, JT7988Y-AS is single-chip microcomputer for 10-digit + 2-digit scientific calculator.

T7988, JT7988Y-AS is the complete single-chip CMOS LSI for electronic calculator with 10 digits, 67 functions, 3 expression and hexadecimal, octal and binary, statistic calculation, fractional number calculation, and logic operation with the following features.

FEATURES

- 12-digit display plus 2-digit code at the right margin.
 - Scientific and engineering display.
Mantissa 10 digits plus exponent 2 digits plus negative code 2 digits.
 - Other than above
Mantissa 10 digits plus negative code 1 digit.

- 13 kinds of special display

M	Memory	HEX	Hexadecimal mode
-	Mantissa and exponent Minus	SD	Statistic calculation mode
E	Error	DEG	Degree
INV	Inverse	RAD	Radian
HYP	Hyperbolic	GRAD	Gradian
BIN	Binary mode	()	Parenthesis calculation
OCT	Octal mode		

- The minus sign of the mantissa is floating minus.
- The arithmetic key operation in clouding Y^x or ${}^x\sqrt{Y}$ has same sequence as mathematical equation. 6 pending operations are allowed and () are up to continuous 15 levels.
- Fractional number calculation.
- It is possible to convert mutually between decimal, binary, octal and hexadecimal, and the 4 operations in arithmetic in binary, octal and hexadecimal.

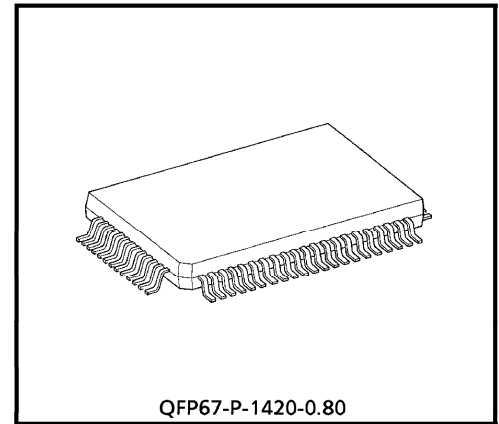

Weight : 1.20g (Typ.)

- One independent accumulating memory.
- It is possible to convert or fix the display number system by FLO (Floating) , SCI (Scientific) or ENG (Engineering) key.
- It is possible to specify decimal part digits (0~9) by FIX key.
- Direct drive for FEM LCD (1/2 prebias, 1/3 duty) .
- Automatic power on clear.
- Low-power consumption. $V_G = -1.5V$ single power supply.
- The 67-pin flat package is used.

SYSTEM BLOCK DIAGRAM

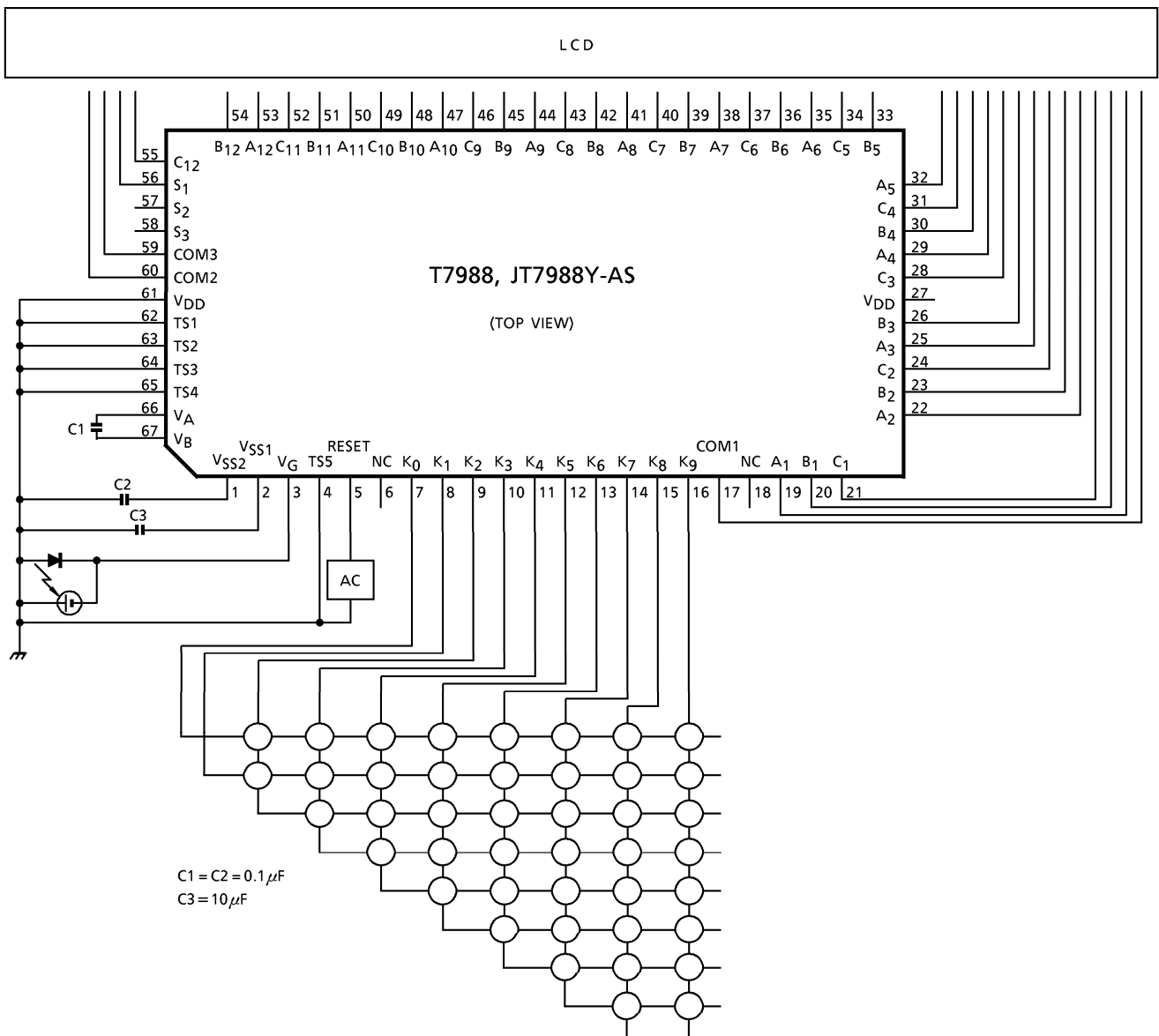

CONNECTION OF LCD

SEGMENT

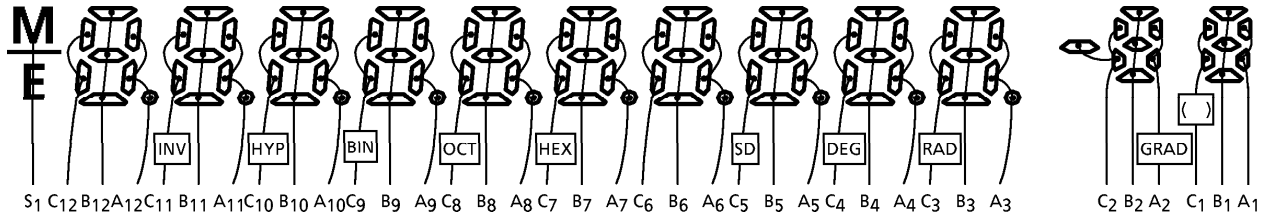

COMMON

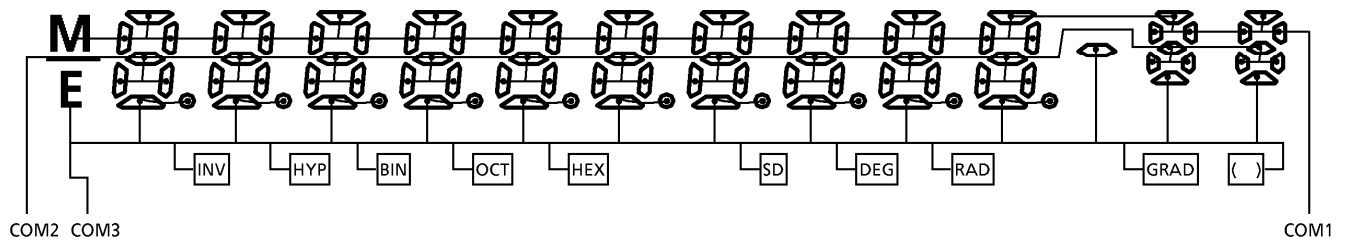

SET KEY LAYOUT (Example)

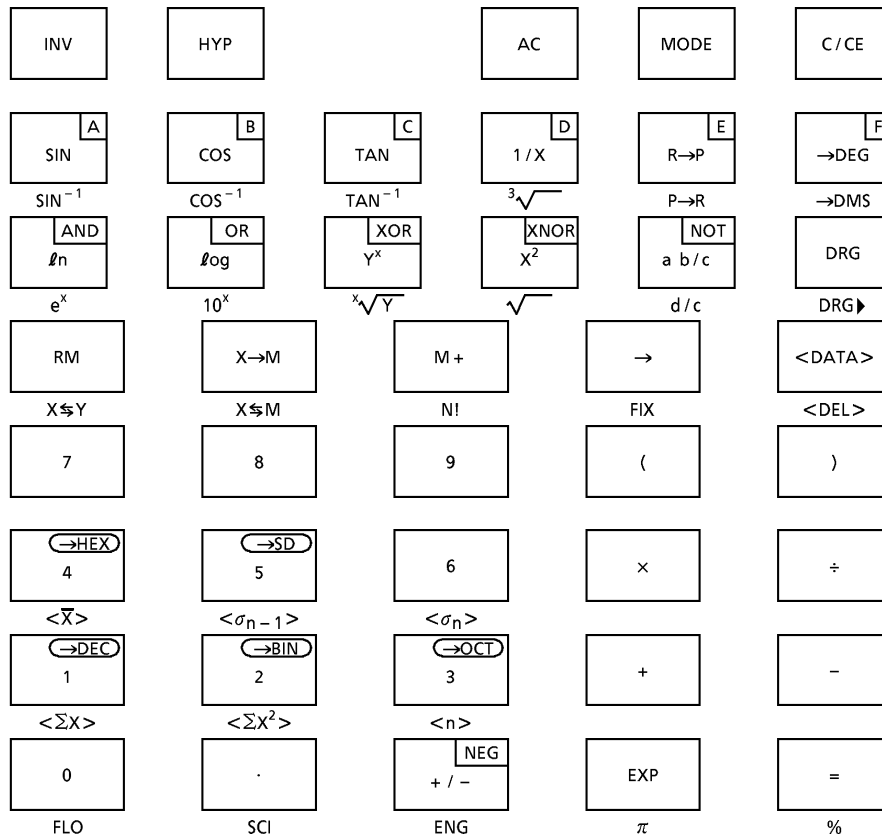

KEY CONNECTION

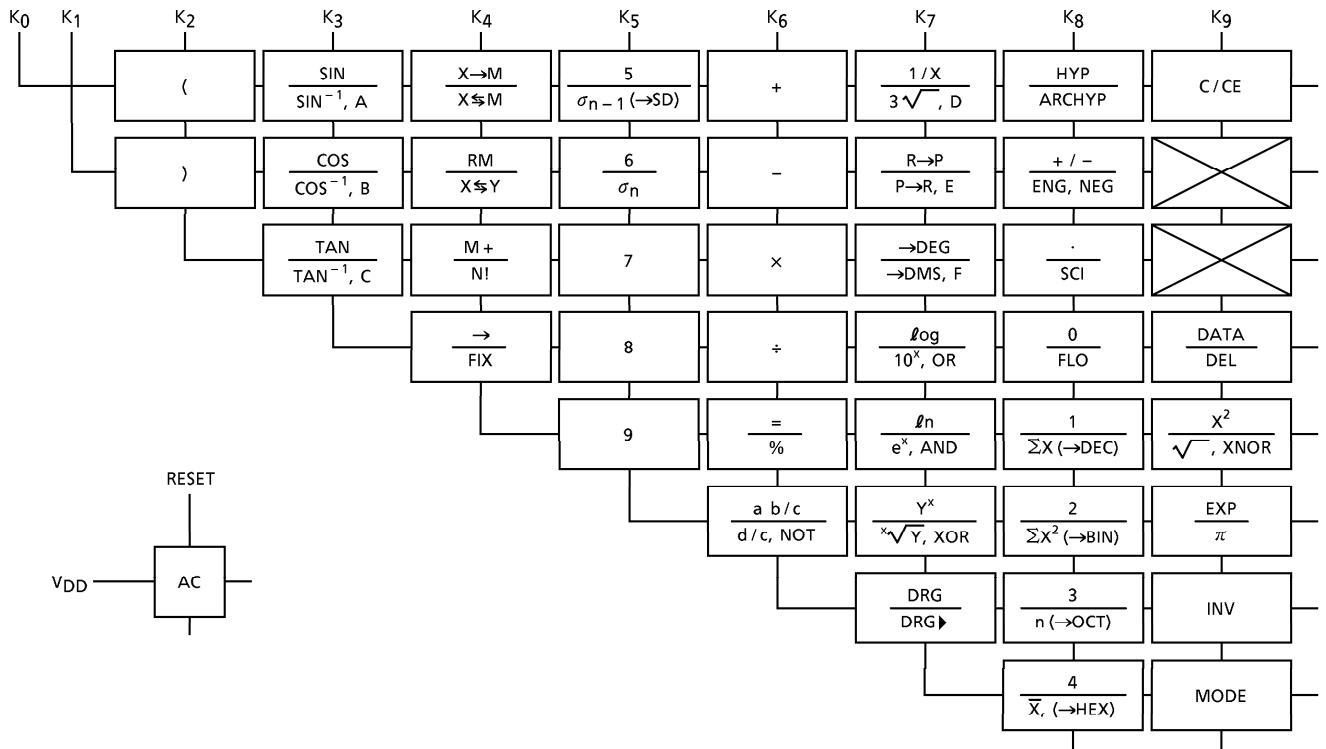

PIN ASSIGNMENT

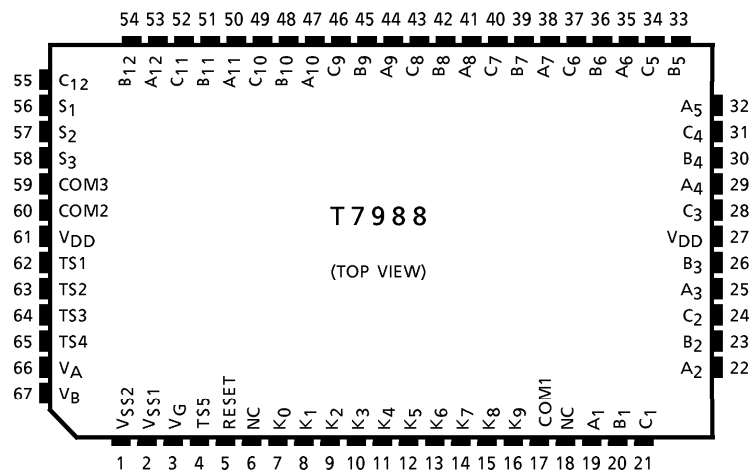

SPECIFICATION OF CALCULATOR

Speed of calculation

Key on 10ms

Key off 33.8ms

$f\phi_{WAIT} = 9\text{kHz}$, $f\phi_{op} = 24\text{kHz}$

The calculation speed doesn't include the key on or off time.

ITEM	OPERATION			CALCULATION SPEED (ms)
Number	DEC		5	26
			5	25
	HEX		A	26
			A	25
Function	DEC		+	69
			×	73
	HEX		-	172
			÷	176
4 operation	DEC	1 + 2	+	97
		1 0 0 0 0 0 0 0 0 0 - 1	-	104
		5 × 9	×	104
		5 5 5 5 5 × 9 9 9 9 9	×	120
	HEX	5 ÷ 9	÷	157
		5 5 5 5 5 ÷ 9 9 9 9 9	÷	193
		A B C + D E F	+	291
		A B C - D E F	-	479
$Y^X, X\sqrt{Y}$		A B C × D E F	×	334
		A B C ÷ D E F	÷	324
SIN	DEG	3 Y ^x 4	=	842
	RAD	3 ^x √Y 4	=	872
	GRAD	3 0	SIN	798
COS	DEG	$\pi \div 6 =$	SIN	764
	RAD	1 0 0 ÷ 3 =	SIN	1161
	GRAD	6 0	COS	809
TAN	DEG	$\pi \div 3 =$	COS	1031
	RAD	200 ÷ 3 =	COS	1176
	GRAD	4 5	TAN	386
SIN^{-1}	DEG	$\pi \div 4 =$	TAN	143
	RAD	5 0	TAN	154
	GRAD	0. 5	SIN^{-1}	836
COS^{-1}	DEG	0. 5	SIN^{-1}	653
	RAD	0. 5	SIN^{-1}	825
	GRAD	0. 5	COS^{-1}	1069
TAN^{-1}	DEG	0. 5	COS^{-1}	762
	RAD	0. 5	COS^{-1}	1057
	GRAD	1	TAN^{-1}	237
Ln		1	TAN^{-1}	147
Log		1	TAN^{-1}	236
		2 0	ln	160
		2 0	log	332

ITEM	OPERATION			CALCULATION SPEED (ms)
e ^x		2 0	e ^x	315
10 ^x		1. 2 3	10 ^x	380
		1 0	10 ^x	137
X!		6 9	N!	970
HYP		3 hyp	SIN	623
		3 hyp	COS	627
		3 hyp	TAN	766
ARC HYP		3 hyp ⁻¹	SIN	607
		3 hyp ⁻¹	COS	677
		0.5 hyp ⁻¹	TAN	574
X ²		2 0	X ²	64
√		2 0	√	217
1/X		2 0	1/X	80
³ √		2 0	³ √	604
Mutual Conversion	DEC	1 2 3	→BIN	118
		1 2 3 4 5	→OCT	134
		1 2 3 4 5	→HEX	120
	BIN	1 0 1 0 1	→DEC	93
	OCT	1 2 3 4 5	→DEC	112
HEX	A B C D E	→DEC	181	
→DEG		1.2 3 4 5	→DEG	265
→DMS		1.2 3 4 5	→DMS	304
R→P	DEG	³ √ X↔Y 1	R→P	920
	RAD	³ √ X↔Y 1	R→P	723
	GRAD	³ √ X↔Y 1	R→P	919
P→R	DEG	2 X↔Y 3 0	P→R	1543
	RAD	2 X↔Y 30 DRG▶	P→R	1461
	GRAD	2 X↔Y 30 DRG▶ DRG▶	P→R	2089
→RAD	DEG	3 6 0	DRG▶	147
→GRAD	RAD	2 × π =	DRG▶	100
→DEG	GRAD	4 0 0	DRG▶	71
Memory		1 2 3	X→M	47
		1 2 3 X → M	M +	65
		1 2 3 X → M	RM	41
		1 2 3 X → M	X↔M	54
%		1 2 3 + 4 5 6	%	86
		1 2 3 - 4 5 6	%	86
		1 2 3 × 4 5 6	%	56
		1 2 3 ÷ 4 5 6	%	56
Exchange		1 2 3 + 4 5 6	X↔Y	52
Shift		1 2 3	→	27

ITEM	OPERATION						CALCULATION SPEED (ms)
Statistic Calculation	1 DATA 2 DATA 3 DATA 8 DATA 9					DATA	125
						n	56
						\bar{X}	74
	The above-mentioned data					ΣX	51
						ΣX^2	52
						σ_{n-1}	300
σ_n						347	
Logic operation	HEX	A B C		AND	D E F	=	603
		A B C		OR	D E F	=	650
		A B C		XOR	D E F	=	568
		A B C		XNOR	D E F	=	961
NEG	HEX			A B C	NOT	394	
Fractional number calculation	Function	2 ab/c 3 6 ab/c 2 3 4				-	249
		2 ab/c 3 6 ab/c 2 3 4				÷	253
	4-operation	2 $\frac{\quad}{\quad}$ 36 J 234 + 3 $\frac{\quad}{\quad}$ 45 J 345				=	536
		2 $\frac{\quad}{\quad}$ 36 J 234 - 3 $\frac{\quad}{\quad}$ 45 J 345				=	512
		2 $\frac{\quad}{\quad}$ 36 J 234 × 3 $\frac{\quad}{\quad}$ 45 J 345				=	498
2 $\frac{\quad}{\quad}$ 36 J 234 ÷ 3 $\frac{\quad}{\quad}$ 45 J 345				=	562		

OPERATION RANGE AND ACCURACY

FUNCTION	ANGLE UNIT	OPERATION RANGE	UNDER FLOW AREA	NORMAL ACCURACY
SIN X	DEG	$0 \leq X \leq 4.499999999 \times 10^{10}$	$0 \leq X \leq 5.729577951 \times 10^{-98}$	± 1 in 10th significant digit
	RAD	$0 \leq X \leq 785398163.3$	—	
	GRAD	$0 \leq X \leq 4.999999999 \times 10^{10}$	$0 \leq X \leq 6.366197723 \times 10^{-98}$	
COS X	DEG	$0 \leq X \leq 4.500000008 \times 10^{10}$	—	
	RAD	$0 \leq X \leq 785398164.9$	—	
	GRAD	$0 \leq X \leq 5.000000009 \times 10^{10}$	—	
TAN X	DEG	SAME AS SINX except for $ X = (2n - 1) \cdot 90$	SAME AS SINX	
	RAD	SAME AS SINX except for $ X = (2n - 1) \cdot \pi / 2$	SAME AS SINX	
	GRAD	SAME AS SINX except for $ X = (2n - 1) \cdot 100$	SAME AS SINX	
SIN ⁻¹ X	DEG	$0 \leq X \leq 1$	$0 \leq X \leq 1.570796326 \times 10^{-99}$	
	RAD	$0 \leq X \leq 1$	—	
	GRAD	$0 \leq X \leq 1$	$0 \leq X \leq 1.570796326 \times 10^{-99}$	
COS ⁻¹ X	DEG	SAME AS SIN ⁻¹ X	—	
	RAD	SAME AS SIN ⁻¹ X	—	
	GRAD	SAME AS SIN ⁻¹ X	—	
TAN ⁻¹ X	DEG	$0 \leq X \leq 9.999999999 \times 10^{99}$	SAME AS SIN ⁻¹ X	
	RAD	$0 \leq X \leq 9.999999999 \times 10^{99}$	—	
	GRAD	$0 \leq X \leq 9.999999999 \times 10^{99}$	SAME AS SIN ⁻¹ X	

FUNCTION	OPERATION RANGE	UNDER FLOW AREA	NORMAL ACCURACY
LN X	0 < X	—	± 1 in 10th significant digit
LOG X	0 < X	—	
e ^x	- 9.99999999 × 10 ⁹⁹ ≤ X ≤ 230.2585092	- 9.99999999 × 10 ⁹⁹ ≤ X ≤ - 227.9559243	
10 ^x	- 9.99999999 × 10 ⁹⁹ ≤ X ≤ 99.99999999	- 9.99999999 × 10 ⁹⁹ ≤ X ≤ - 99.00000001	
X!	0 ≤ X ≤ 69 (INTEGER)	—	
$\frac{1}{X}$	1 × 10 ⁻⁹⁹ ≤ X ≤ 9.99999999 × 10 ⁹⁹	1.000000001 × 10 ⁹⁹ ≤ X ≤ 9.99999999 × 10 ⁹⁹	
X ²	0 ≤ X ≤ 9.99999999 × 10 ⁴⁹	≤ X ≤ 3.162277660 × 10 ⁻⁵⁰	
√X	0 ≤ X ≤ 9.99999999 × 10 ⁹⁹	—	
$\sqrt[3]{X}$	0 ≤ X ≤ 9.99999999 × 10 ⁹⁹	—	
DMS→DEG	0 ≤ X ≤ 9.99999999 × 10 ⁹	—	
DEG→DMS	0 ≤ X ≤ 9999999.999	0 ≤ X ≤ 1.388888888 × 10 ⁻⁶	± 1 in least significant digit
SINH X	0 ≤ X ≤ 230.2585092	—	± 1 in 10th significant digit
COSH X	0 ≤ X ≤ 230.2585092	—	
TANH X	0 ≤ X ≤ 9.99999999 × 10 ⁹⁹	—	
SINH ⁻¹ X	0 ≤ X ≤ 4.99999999 × 10 ⁹⁹	—	
COSH ⁻¹ X	1 ≤ X ≤ 4.99999999 × 10 ⁹⁹	—	
TANH ⁻¹ X	0 ≤ X ≤ 9.99999999 × 10 ⁻¹	—	
R→P (xy→γθ)	x , y ≤ 9.99999999 × 10 ⁴⁹ (x ² + y ²) ≤ 9.99999999 × 10 ⁹⁹ $\frac{Y}{X}$; SAME AS TAN ⁻¹ X	$\frac{Y}{X}$; SAME AS TAN ⁻¹ X	
P→R (γθ→xy)	0 ≤ γ ≤ 9.99999999 × 10 ⁹⁹ θ ; SAME AS SIN X, COS X	θ ; SAME AS SIN X, COS X	
DEG→RAD	0 ≤ X ≤ 9.99999999 × 10 ⁹⁹	0 ≤ X ≤ 5.729577951 × 10 ⁻⁹⁸	
RAD→GRAD	0 ≤ X ≤ 1.570796326 × 10 ⁹⁸	—	
GRAD→DEG	0 ≤ X ≤ 9.99999999 × 10 ⁹⁹	0 ≤ X ≤ 1.111111111 × 10 ⁻⁹⁹	
Y ^X	- 9.99999999 × 10 ⁹⁹ ≤ X · LN Y ≤ 230.2585092 (1) Y > 0...The above-mentioned operation range. (2) Y < 0...X (Integer) or, 1/X (Odd, X ≠ 0) ...The above-mentioned operation range. (3) Y = 0...0 < X	- 9.99999999 × 10 ⁹⁹ ≤ X · LN Y ≤ - 227.9559243	± 1 in 10th significant digit

FUNCTION	OPERATION RANGE	UNDER FLOW AREA	NORMAL ACCURACY
$\sqrt[X]{Y}$	$-9.999999999 \times 10^{99}$	$-9.999999999 \times 10^{99}$	± 1 in 10th significant digit
	$\leq \frac{1}{X} \cdot \text{LN } Y \leq 230.2585092$	$\leq \frac{1}{X} \cdot \text{LN } Y \leq -227.95593243$	
(1) $Y > 0 \cdots$ The above-mentioned operation range. (2) $Y < 0 \cdots X$ (Odd) or $1/X$ (Integer, $X \neq 0$) \cdots The above-mentioned operation range. (3) $Y = 0 \cdots 0 < X$			
→DEC	Operation range		—
	The following operation range after the conversion. $0 \leq X \leq 9999999999$		
→BIN	The following operation range after the conversion. $1000000000 \leq X \leq 1111111111$ $0 \leq X \leq 1111111111$		—
→OCT	The following operation range after the conversion. $4000000000 \leq X \leq 7777777777$ $0 \leq X \leq 3777777777$		—
→HEX	The following operation range after the conversion. $\text{FDABF41CO1} \leq X \leq \text{FFFFFFFF}$ $0 \leq X \leq 2540\text{BE3FF}$		—
AND OR XOR XNOR	BIN ; $1000000000 \leq X \leq 1111111111$ $0 \leq X \leq 1111111111$ OCT ; $4000000000 \leq X \leq 7777777777$ $0 \leq X \leq 3777777777$ HEX ; The following operation range after the operation. $\text{FDABF41CO1} \leq X \leq \text{FFFFFFFF}$ $0 \leq X \leq 2540\text{BE3FF}$		—
NOT	BIN ; SAME AS AND OCT ; SAME AS AND HEX ; $\text{FDABF41CO1} \leq X \leq \text{FFFFFFFF}$ $0 \leq X \leq 2540\text{BE3FE}$		—
NEG	BIN ; $1000000001 \leq X \leq 1111111111$ $0 \leq X \leq 1111111111$ OCT ; $4000000001 \leq X \leq 7777777777$ $0 \leq X \leq 3777777777$ HEX ; $\text{FDABF41CO1} \leq X \leq \text{FFFFFFFF}$ $0 \leq X \leq 2540\text{BE3FF}$		—

FUNCTION		OPERATION RANGE	NORMAL ACCURACY
Statistic	DATA DEL	$ x \leq 9.999999999 \times 10^{49}$ $ \sum x \leq 9.999999999 \times 10^{99}$ $\sum x^2 \leq 9.999999999 \times 10^{99}$ $0 \leq n \leq 9999999999$. n = Integer	± 1 in 10th significant digit
	\bar{x}	$n \neq 0$	
	σ_{n-1}	$n \neq 1, n \neq 0$ $0 \leq \frac{\sum X^2 - \{(\sum X)^2 / n\}}{n-1} \leq 9.999999999 \times 10^{99}$	
	σ_n	$n \neq 0$ $0 \leq \frac{\sum X^2 - \{(\sum X)^2 / n\}}{n} \leq 9.999999999 \times 10^{99}$	

MAXIMUM RATINGS (Ta = 25°C)

CHARACTERISTICS	SYMBOL	RATING	UNIT
Supply Voltage	V _G	+0.3 ~ -2.2	V
Input Voltage	V _{IN}	+0.3 ~ V _G - 0.3	V
Operating Temperature	T _{opr}	0 ~ 40	°C
Storage Temperature	T _{stg}	-55 ~ 125	°C

ELECTRICAL CHARACTERISTICS (V_G = -1.5V ± 0.2V, V_{SS2} = -3.0 ± 0.4V, V_{DD} = 0V, Ta = 25°C)

CHARACTERISTICS	SYMBOL	TEST CIR-CUIT	PIN NAME	TEST CONDITION	MIN	TYP.	MAX	UNIT
Operating Voltage	V _G	—	—	—	-1.2	-1.5	-2.0	V
Supply Current (I)	I _{DD} WAIT	—	—	V _G = -1.5V, wait	—	2.0	3.0	μA
Supply Current (II)	I _{DD} OP	—	—	V _G = -1.2V, operate	—	4.5	7.0	μA
Oscillating Frequency (I)	F _φ WAIT	—	—	V _G = -1.5V, wait	5.4	9.0	12.6	kHz
Oscillating Frequency (II)	F _φ OP	—	—	V _G = -1.5V, operate	14.4	24.0	33.6	kHz
Frame Frequency	f _F	—	—	V _G = -1.5V, wait	56.3	93.8	131.3	Hz
"1" Input Voltage	V _{IH}	—	K ₂ ~K ₉ RESET	—	V _G + 0.4	—	V _G	V
"0" Input Voltage	V _{IL}	—	K ₂ ~K ₉ RESET	—	V _{DD}	—	-0.4	V
"1" Output Voltage	V _{OH} (I)	—	SEGMENT COM1~3	—	V _{SS2} + 0.2	—	V _{SS2}	V
"0" Output Voltage	V _{OL} (I)	—	SEGMENT COM1~3	—	V _{DD}	—	-0.2	V

CHARACTERISTICS	SYMBOL	TEST CIRCUIT	PIN NAME	TEST CONDITION	MIN	TYP.	MAX	UNIT
"M" Output Voltage	V _{OM}	—	COM1~3	—	V _{SS1} +0.2	—	V _{SS1} -0.2	V
"1" Output Voltage	V _{OH} (II)	—	K ₀ ~K ₉ RESET	—	V _{SS1} +0.2	—	V _{SS1}	V
"0" Output Voltage	V _{OL} (II)	—	K ₀ ~K ₉ RESET	—	V _{DD}	—	-0.2	V
"1" Output Resistance	R _{OH}	—	SEGMENT COM1~3	V _{OUT} = V _{SS2} + 0.5V	—	—	70	kΩ
"0" Output Resistance	R _{OL}	—	SEGMENT COM1~3	V _{OUT} = -0.5V	—	—	70	kΩ
RESET Pull Up Resistance (I)	R _{RESETH} (I)	—	RESET	V _{OUT} = 0V (Note 1)	156	260	364	kΩ
RESET Pull Up Resistance (II)	R _{RESETH} (II)	—	RESET	V _{OUT} = 0V (Note 2)	18	75	300	kΩ
Key Pull Up Resistance (I)	R _{KEYH} (I)	—	K ₀ ~K ₉	V _{OUT} = V _G + 0.5V (Note 3)	—	—	500	kΩ
Key Pull Up Resistance (II)	R _{KEYH}	—	K ₀ ~K ₉	V _{OUT} = 0V (Note 4)	60	300	1500	kΩ
Key RESET Pull Down Resistance	R _{KEYL} RESETL	—	K ₀ ~K ₉ RESET	V _{OUT} = -0.5V (Note 5)	—	—	25	kΩ

(Note 1, 2, 5) RESET Waveform, 1-cycle

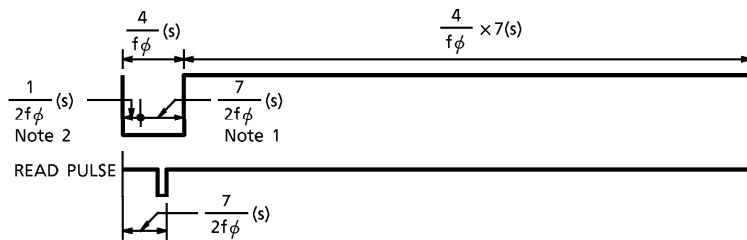

(Note 3, 4, 5) KEY Waveform, 1-cycle

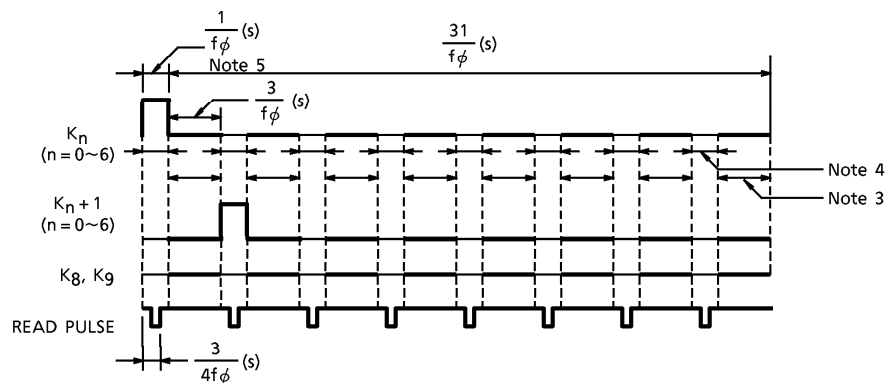

WAVEFORMS FOR DISPLAY

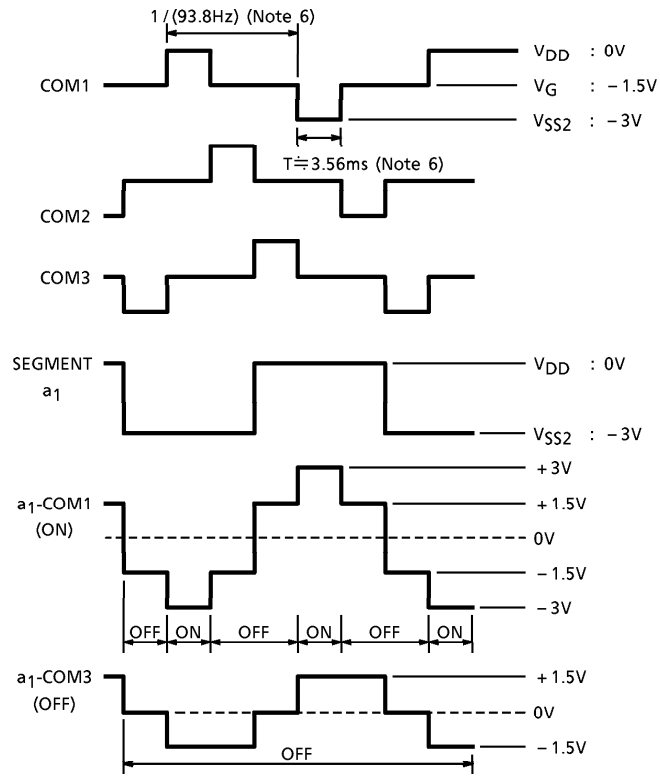

(Note 6) : $F_{\phi} \text{ WAIT} = 9\text{kHz}$

PAD LOCATION TABLE

(μm)

NAME	X POINT	Y POINT
VSS2	- 1215	1536
VSS1	- 1404	1494
VG	- 1404	1260
TS5	- 1404	1059
RESET	- 1404	873
K0	- 1404	612
K1	- 1404	450
K2	- 1404	288
K3	- 1404	126
K4	- 1404	- 36
K5	- 1404	- 198
K6	- 1404	- 360
K7	- 1404	- 522
K8	- 1404	- 684
K9	- 1404	- 846
COM1	- 1404	- 1008
A1	- 1404	- 1377
B1	- 1326	- 1539
C1	- 1164	- 1539
A2	- 1002	- 1539
B2	- 758	- 1539
C2	- 596	- 1539
A3	- 434	- 1539
B3	- 272	- 1539
C3	127	- 1539
A4	289	- 1539
B4	451	- 1539
C4	613	- 1539
A5	775	- 1539
B5	1002	- 1539
C5	1164	- 1539
A6	1326	- 1539

NAME	X POINT	Y POINT
B6	1404	- 1377
C6	1404	- 1170
A7	1404	- 1008
B7	1404	- 846
C7	1404	- 684
A8	1404	- 522
B8	1404	- 360
C8	1404	- 198
A9	1404	- 36
B9	1404	126
C9	1404	288
A10	1404	450
B10	1404	612
C10	1404	774
A11	1404	936
B11	1404	1098
C11	1404	1260
A12	1404	1494
B12	1215	1536
C12	1053	1536
S1	869	1536
S2	707	1536
S3	545	1536
COM3	383	1536
COM2	218	1536
VDD	0	1536
TS1	- 218	1536
TS2	- 380	1536
TS3	- 542	1536
TS4	- 729	1536
VA	- 891	1536
VB	- 1053	1536

CHIP LAYOUT

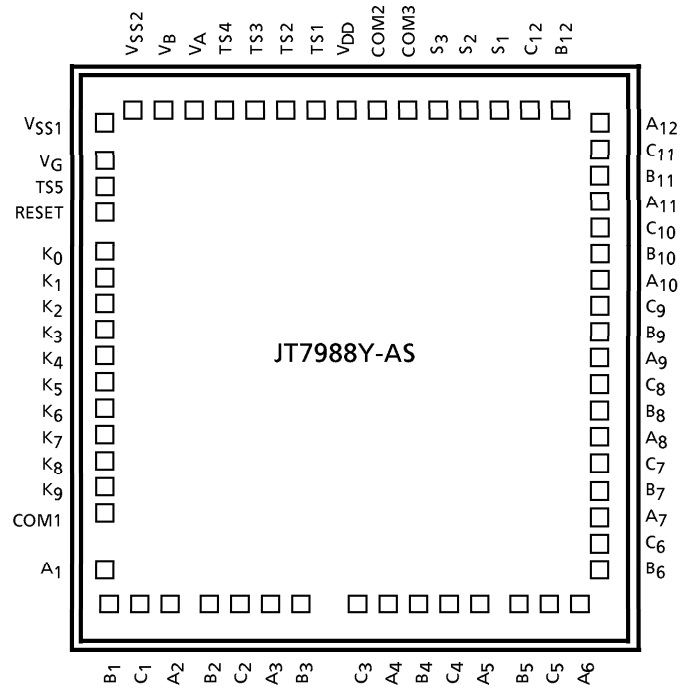

Chip size : 3.08 x 3.41 [mm]
 Chip thickness : 450 ± 20 [μm]
 Substrate : V_{DD}

PAD LAYOUT

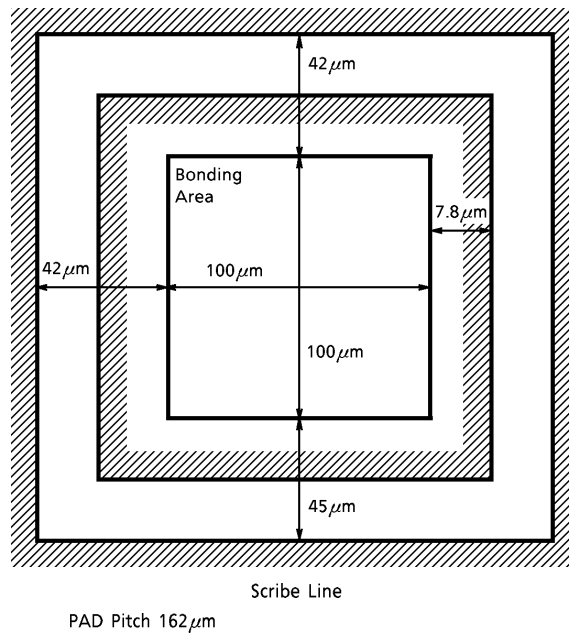

RESTRICTIONS ON PRODUCT USE

000707EBA

- TOSHIBA is continually working to improve the quality and reliability of its products. Nevertheless, semiconductor devices in general can malfunction or fail due to their inherent electrical sensitivity and vulnerability to physical stress. It is the responsibility of the buyer, when utilizing TOSHIBA products, to comply with the standards of safety in making a safe design for the entire system, and to avoid situations in which a malfunction or failure of such TOSHIBA products could cause loss of human life, bodily injury or damage to property. In developing your designs, please ensure that TOSHIBA products are used within specified operating ranges as set forth in the most recent TOSHIBA products specifications. Also, please keep in mind the precautions and conditions set forth in the "Handling Guide for Semiconductor Devices," or "TOSHIBA Semiconductor Reliability Handbook" etc..
- The TOSHIBA products listed in this document are intended for usage in general electronics applications (computer, personal equipment, office equipment, measuring equipment, industrial robotics, domestic appliances, etc.). These TOSHIBA products are neither intended nor warranted for usage in equipment that requires extraordinarily high quality and/or reliability or a malfunction or failure of which may cause loss of human life or bodily injury ("Unintended Usage"). Unintended Usage include atomic energy control instruments, airplane or spaceship instruments, transportation instruments, traffic signal instruments, combustion control instruments, medical instruments, all types of safety devices, etc.. Unintended Usage of TOSHIBA products listed in this document shall be made at the customer's own risk.
- The products described in this document are subject to the foreign exchange and foreign trade laws.
- The information contained herein is presented only as a guide for the applications of our products. No responsibility is assumed by TOSHIBA CORPORATION for any infringements of intellectual property or other rights of the third parties which may result from its use. No license is granted by implication or otherwise under any intellectual property or other rights of TOSHIBA CORPORATION or others.
- The information contained herein is subject to change without notice.