

MT2 Relay

- Telecom/signal relay (dry circuit, test access, ringing)
- Slim line 20x10mm (.795x.393")
- Switching current 2A
- 2 form C contacts (2 CO, 2 changeover contacts)
- Bifurcated contacts
- Meets FCC Part 68 and ITU-T K20



Typical applications

Communications equipment, linecard application – analog, ISDN, xDSL, PABX, voice over IP, office and business equipment, measurement and control equipment, consumer electronics, set top boxes, HiFi, medical equipment, automotive Equipment

Approvals

UL 508 File No. E 111441
Technical data of approved types on request

Contact Data

Contact arrangement	2 form C (2 CO)
Max. switching voltage	220VDC, 250VAC
Rated current	2A
Limiting continuous current, 85°C	2A
Contact material	AgNi, gold-covered
Contact style	bifurcated contacts
Min. recommended contact load	10mA at 20mV
Minimum switching voltage	100µV
Initial contact resistance	< 70mΩ at 10mA, 20mV
Frequency of operation, without load max.	50 operations/s
Operate / release time max.	5ms/3ms
Bounce time max.	5ms
Electrical endurance	
contact application 0 (≤30mV/≤10mA)	min. 5x10 ⁶ operations
cable load open end	min. 2.5x10 ⁶ operations
resistive load 150V/0.2A - 30W	min. 2x10 ⁵ operations
24V/1.25A - 30W	min. 2x10 ⁵ operations
Contact ratings, UL	220VDC/0.24A - 60W 125VDC/0.24A - 30W 250VAC/0.25A - 62.5VA 125VAC/0.5A - 62.5VA 30VDC/2A - 60W
Mechanical endurance	typ. 100x10 ⁶ operations

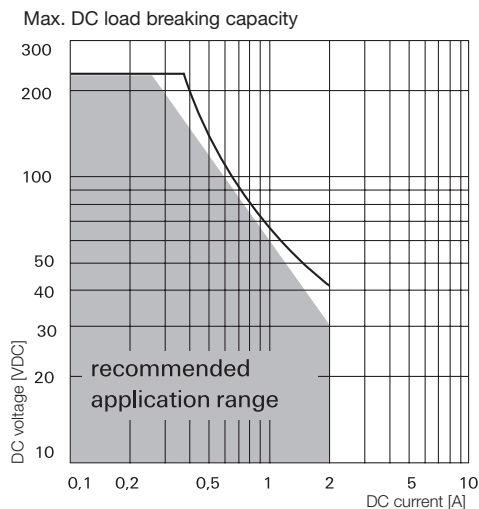

Coil Data

Magnetic system	neutral
Coil voltage range	3 to 48VDC
Max. coil temperature	115°C
Thermal resistance	< 85K/W

Coil versions, monostable

Coil code	Rated voltage VDC	Operate voltage VDC	Limiting Voltage VDC	Release voltage VDC	Coil resistance Ω±10%	Rated coil power mW
High sensitive version, 150mW						
00	3	2.1	8.1	0.3	60	150
07	3.3	2.3	8.8	0.33	72	150
06	4.5	3.2	12.2	0.45	136	150
01	5	3.6	13.5	0.5	168	150
27	6	4.3	16.2	0.6	240	150
05	9	6.4	24.3	0.9	544	150
02	12	8.6	32.4	1.2	968	150
03	24	17.1	64.8	2.4	3872	150
04	48	34.1	129.6	4.8	15468	150
Sensitive version, 200mW						
14	3	2	7	0.3	45	200
15	4.5	2.9	10.5	0.45	101	200
16	5	3.3	11.6	0.5	125	200
28	6	3.9	14	0.6	180	200
17	9	5.9	21	0.9	405	200
18	12	7.8	28	1.2	720	200
19	24	15.6	59.9	2.4	2880	200
20	48	31.2	112	4.8	11520	200
Sensitive version, 300mW						
33	4.5	3.1	8.9	0.45	73	300
34	5	3.4	9.9	0.5	90	300
12	12	8.25	23.6	1.2	515	300
35	24	16.5	47.3	2.4	2060	300
36	48	32.5	94.6	4.8	8240	300
Standard version, 400mW						
21	4.5	2.9	8.9	0.45	50	400
22	5	3.3	9.9	0.5	63	400
29	6	3.9	11.8	0.6	90	400
23	9	5.9	17.7	0.9	203	400
24	12	7.8	23.6	1.2	360	400
25	24	15.6	47.3	2.4	1440	400
26	48	31.2	94.6	4.8	5760	400
Standard version, 550mW						
38	4.5	2.9	6.3	0.45	36	550
50	5	3.3	7	0.5	45	550
37	6	3.9	8.4	0.6	66	550
32	12	7.8	16.8	1.2	280	550
31	24	15.6	33.6	2.4	1050	550
30	48	31.2	67.2	4.8	4100	550

All figures are given for coil without pre-energization, at ambient temperature +23°C.
Other coil voltages on request.

MT2 Relay (Continued)

Coil Data (continued)

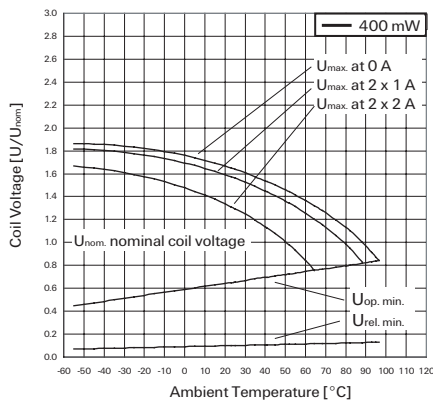
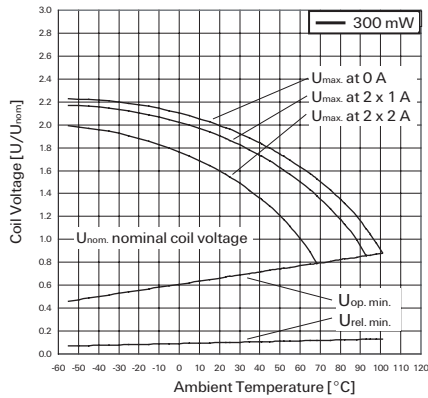
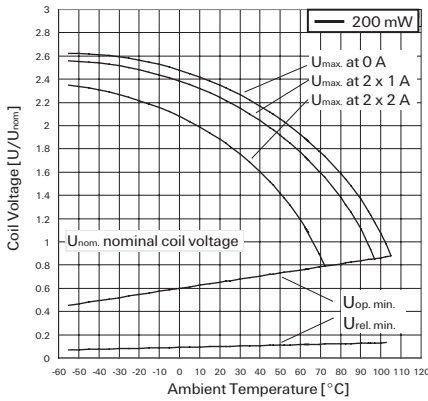
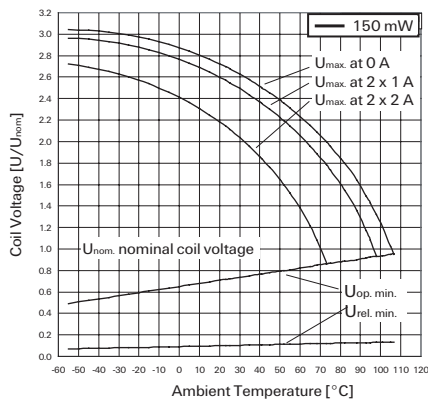

Coil Data (continued)

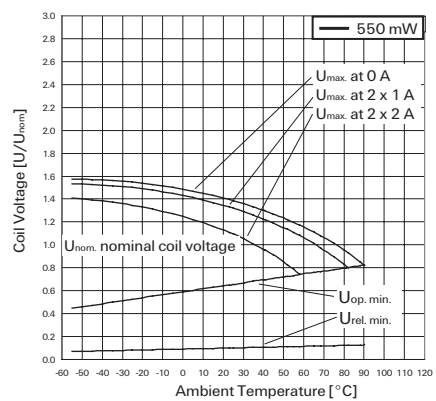

Coil operative range graphs

- U_{nom} Nominal coil voltage
- U_{max} Upper limit of the operative range of the coil voltage (limiting voltage) when coils are continuously energized
- $U_{op. min.}$ Lower limit of the operative range of the coil voltage (reliable operate voltage)
- $U_{rel. min.}$ Lower limit of the operative range of the coil voltage (reliable release voltage)

Insulation Data

Initial dielectric strength	
between open contacts	750V _{rms}
between contact and coil	1050V _{rms}
between adjacent contacts	750V _{rms}
Initial surge withstand voltage	
between open contacts	1500V
between contact and coil	1500V
between adjacent contacts	1500V
Initial insulation resistance at 500VDC	> 10 ⁹ Ω
Capacitance	
between open contacts	max. 2pF
between contact and coil	max. 4pF
between adjacent contacts	max. 2 pF

RF Data

Isolation at 100MHz/900MHz	-31.8dB/-14.2dB
Insertion loss at 100MHz/900MHz	-0.02dB/-0.97dB
Voltage standing wave ratio (VSWR) at 100MHz/900MHz	1.03/1.31

Other Data

Material compliance: EU RoHS/ELV, China RoHS, REACH, Halogen content refer to the Product Compliance Support Center at www.te.com/customer-support/rohssupportcenter

Ambient temperature	-55 to +85°C
Category of environmental protection	IEC 61810
Degree of protection, IEC 60529	RT III - immersion cleanable
Vibration resistance (functional)	IP 67
Shock resistance (functional)	10g, 10 to 500Hz
IEC 60068-2-27 (half sine)	10g/30g
Shock resistance (destructive)	500g
Terminal type	PCB-THT
Weight	max. 5g
Resistance to soldering heat THT	
IEC 60068-2-20	265 °C / 10 s
Ultrasonic cleaning	not recommended
Packaging unit	1000 pcs.

MT2 Relay (Continued)

Terminal assignment

TOP view on component side of PCB

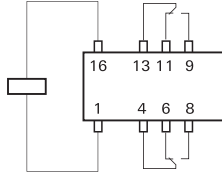

PCB layout

TOP view on component side of PCB

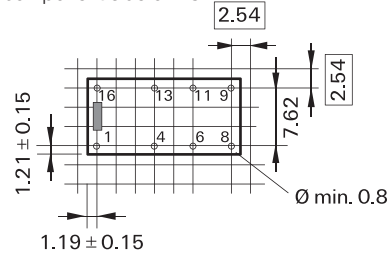

Dimensions

Orientation mark

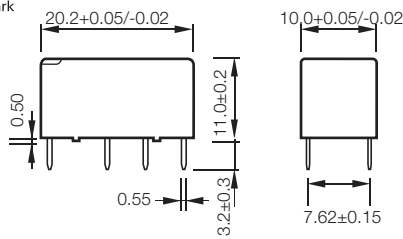

Packing

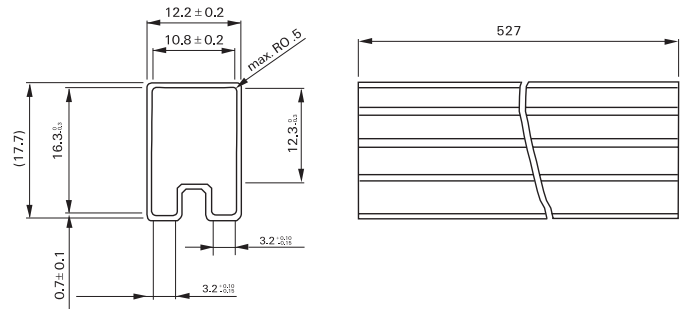

Product code structure

Typical product code **C934** **22**

Type
C934 MT2 Series Signal Relay
2 form C, 2 CO, AgNi +Au contacts

Coil
Coil code: please refer to coil versions table

MT2 Relay (Continued)

Product Code	Version	Coil	Coil power	Coil voltage	Part number			
C93400	2 form C (2CO) AgNi+Au contacts	High sensitive	150mW	3VDC	1-1462001-2			
C93407				3.3VDC	1-1462001-3			
C93406				4.5VDC	2-1462000-2			
C93401				5VDC	1462000-1			
C93427				6VDC	5-1462000-6			
C93405				9VDC	2-1462000-0			
C93402				12VDC	1462000-7			
C93403				24VDC	1-1462000-3			
C93404				48VDC	1-1462000-8			
C93414				Sensitive	200mW	3VDC	1-1462001-1	
C93415						4.5VDC	3-1462000-0	
C93416						5VDC	3-1462000-1	
C93428						6VDC	5-1462000-7	
C93417						9VDC	3-1462000-6	
C93418	12VDC	3-1462000-7						
C93419	24VDC	4-1462000-1						
C93420	48VDC	4-1462000-5						
C93433	Sensitive	300mW	4.5VDC			6-1462000-6		
C93434			5VDC			6-1462000-8		
C93412			12VDC			2-1462000-6		
C93435			24VDC			7-1462000-0		
C93436			48VDC			7-1462000-2		
C93421			Standard			400mW	4.5VDC	4-1462000-7
C93422				5VDC	4-1462000-8			
C93429				6VDC	5-1462000-8			
C93423				9VDC	5-1462000-0			
C93424				12VDC	5-1462000-1			
C93425				24VDC	5-1462000-3			
C93426				48VDC	5-1462000-5			
C93438				Standard	550mW		4.5VDC	7-1462000-7
C93450							5VDC	8-1462000-5
C93437	6VDC	7-1462000-6						
C93432	12VDC	6-1462000-2						
C93431	24VDC	6-1462000-1						
C93430	48VDC	5-1462000-9						