

TPC
Metallized Polyester
Film Dielectric Capacitors

Comparative Table of the Plastic Film Dielectric Characteristics	2
Characteristics of the Metallized Polyester Film Dielectric Capacitors.....	3
Type Selection Guide.....	6
How To Order	7
Types & Taping	
Radial Leads	
BF (CPM-83).....	8
BH (CPM-N).....	10
BT (CPM-85)	14
BG (CPM-85)	18
BC/BD	22
BO (CPM-50)	24
S4 (CPM-13)	28
Axial Leads	
S8 (CPM-8).....	31
SH (CPM-8)	34
S9 (CPM-72)	38
SG (CPM-72)	41
ST	45
Guide for Customer's Specific Requirements	48
Normalized Series and Associated Values	49

As we are anxious that our customers should benefit from the latest developments in the technology and standards, AVX reserves the right to modify the characteristics published in this brochure.

NOTICE: Specifications are subject to change without notice. Contact your nearest AVX Sales Office for the latest specifications. All statements, information and data given herein are believed to be accurate and reliable, but are presented without guarantee, warranty, or responsibility of any kind, expressed or implied. Statements or suggestions concerning possible use of our products are made without representation or warranty that any such use is free of patent infringement and are not recommendations to infringe any patent. The user should not assume that all safety measures are indicated or that other measures may not be required. Specifications are typical and may not apply to all applications.



Metallized Polyester Film Dielectric Capacitors

Characteristics

INTRODUCTION

The intrinsic characteristics of polyester as a dielectric are:

- dielectric permittivity
- dielectric strength
- range of working temperatures (-55°C to +100°C and up to 125°C for high temperature version).

They are particularly intended for use in bonding, chopping and other applications where the AC component is weak in comparison with the continuous nominal voltage.

TECHNOLOGY EMPLOYED

The outstanding characteristic of the metallized film technology is the self-healing by evaporation of the metallized area around a dielectric fault, thus allowing the electrical insulation of the fault in the film.

PLASTIC FILM DIELECTRIC CHARACTERISTICS

Characteristics	Polypropylene	Polycarbonate	Polystyrene	Polyester
Dielectric Constant (25°C / 50 Hz)	2.2	2.8	2.5	3.2
Minimum Thickness (in micron)	4	2	6	1
Maximum Working Temperature (°C)	100	125	85	125
Can Be Metallized	yes	yes	no	yes
Tangent Of Loss Angle (25°C / 1000 Hz)	2	8	2	50
Insulation Resistance (GΩ x μF)	100	50	100	50
Water Absorption % in weight	< 0.01	0.3	0.1	0.2
Temperature Coefficient (ppm / °C)	-300	±100	-120	+1200
Dielectric Strength (kV / mm)	350	180	150	250

Metalized Polyester Film Dielectric Capacitors



Characteristics

GENERAL ELECTRIC CHARACTERISTICS

Applicable specifications:

- General specifications:
CEI 384-1/CECC 30.000/NFC 83.100
- Sectional specifications:
CEI 384-2/CECC 30.400/ NFC 83.151

1 - Nominal capacitance (C_R) and capacitance tolerances

Nominal capacitance values are based on the E6 and E12 series (see tables of standard values on inside back cover) and their multiples and decimals with the associated tolerances are shown in the table below.

Tolerances	
Values	Code
5%	J
10%	K
20%	M

• Capacitance measurement between terminals:

Measurement frequency:

$$1 \text{ kHz } (\pm 0.1 \text{ kHz}) \rightarrow C_R \leq 1 \mu\text{F}$$

$$100 \text{ Hz } (\pm 5 \text{ Hz}) \rightarrow C_R > 1 \mu\text{F}$$

• Measurement voltage

Peak value of applied voltage should not exceed, at 1kHz, 3% of the nominal voltage V_R and at 100 Hz, 20% of the nominal value with a maximum of 100 V ($70 V_{RMS}$).

TYPICAL CURVES

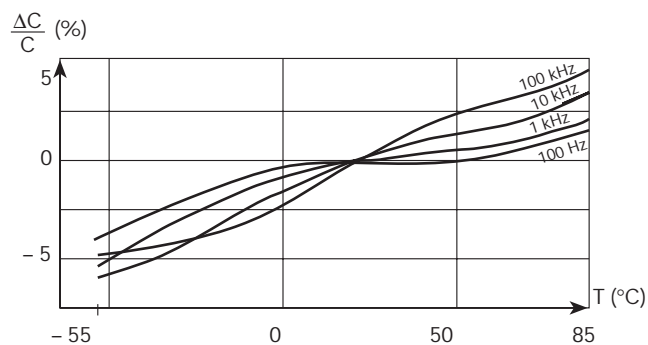
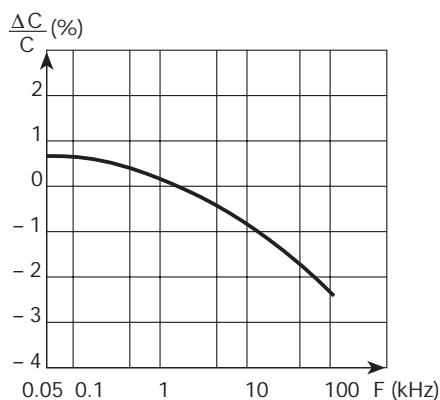

Metallized Polyester Film Dielectric Capacitors



Characteristics

2 - DC nominal voltage (V_R)

The nominal voltage is the maximum DC voltage that may be applied to the capacitor at a temperature of 85°C.

Standard values: the standard values of the nominal voltage comply with the R5 basic series standard numbers in the ISO R3 recommendation (25-40-63-100-160) and their multiples and decimals.

3 - AC nominal voltage ($V_{R_{AC}}$)

The frequency is 50 Hz unless a higher frequency is specified.

4 - Category voltage (V_C)

The voltage category is the voltage that can be applied to a capacitor used at the maximum temperature of its category. This voltage is specified in the data sheet or detailed specification for each product.

5 - Test voltage (V_T)

The test voltage applied between output terminals is a DC voltage equal to:

- 1.4 V_R - for 1 minute for Class 2 capacitors (general use)
- 1.6 V_R - for 1 minute for Class 1 capacitors (long life)

6 - Tangent of loss angle (D.F.)

Measurement conditions:

- identical to those for the measurement of capacitance between terminals.

Requirements:

- the tangent of loss angle should not exceed the values shown in the table below.

Measurement frequency	Capacitance	D.F.	
		Performance category 1	Performance category 2
1 kHz	$C_R \leq 1 \mu F$	$\leq 0.8\%$	$\leq 1.0\%$
100 Hz	$C_R > 1 \mu F$	$\leq 1\%$	$\leq 1.0\%$

TYPICAL CURVES

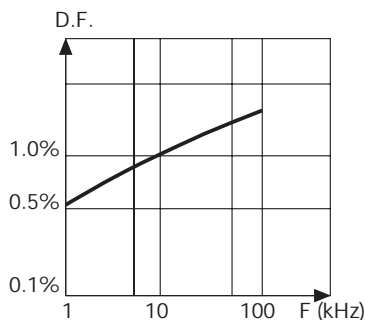

T: Room Temperature

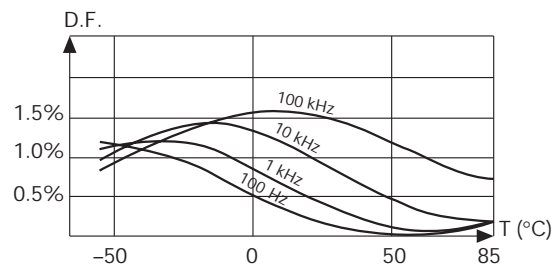

Metallized Polyester Film Dielectric Capacitors

Characteristics



7 - Insulation resistance (IR)

Measurement conditions:

- The opposite table gives the measurement voltages in relation to the nominal voltage of the capacitor, unless otherwise specified.

Requirements:

- The insulation resistance should meet the values shown in the table below at 20°C.

Nominal Voltage	Measurement Voltage
$V_R < 10 \text{ V}$	$V_R \pm 10\%$
$10 \text{ V} \leq V_R < 100 \text{ V}$	$10\text{V} \pm 1 \text{ V}$
$100 \text{ V} \leq V_R < 500 \text{ V}$	$100\text{V} \pm 15 \text{ V}$
$500 \text{ V} \leq V_R$	$500\text{V} \pm 50 \text{ V}$

Measuring Points	$C_R \leq 0.33 \mu\text{F}$				$C_R > 0.33 \mu\text{F}$			
	IR min (GΩ)				IR x C _R min (MΩ x μF)			
	Performance Class 1		Performance Class 2		Performance Class 1		Performance Class 2	
Between Terminals	$V_{R-} \leq 100 \text{ V}$	$V_{R-} > 100 \text{ V}$	$V_{R-} \leq 100 \text{ V}$	$V_{R-} > 100 \text{ V}$	$V_{R-} \leq 100 \text{ V}$	$V_{R-} > 100 \text{ V}$	$V_{R-} \leq 100 \text{ V}$	$V_{R-} > 100 \text{ V}$
	15	30	3.75	7.5	5,000	10,000	1,250	2,500
Between Terminals and Ground	$\geq 30,000 \text{ M}\Omega$							

TYPICAL CURVE

Insulation resistance vs. temperature $IR = f(T) \text{ } ^\circ\text{C}$.

IR (MΩ x μF)

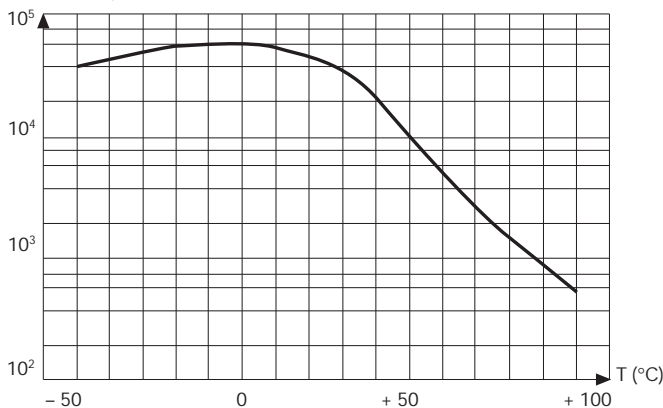

8 - Voltage gradient (dv/dt)_R

- Pulses under V_R

Example:

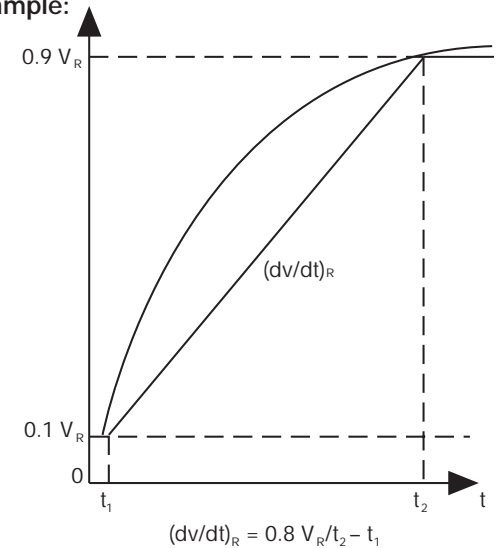

- Pulses under V_A
maximum voltage gradients of the capacitor under V_A :

$$(dv/dt)_{Amax} = \frac{V_R}{V_A} \times (dv/dt)_{Rmax}$$

Metallized Polyester Film Dielectric Capacitors



Type Selection Guide

Presentation	Type		Nominal Voltage		Capacitance Range (C_R)	Tolerance on C_R (Series)	Lead Spacing mm (inches)
	TPC	UTE	$V_R(V)$	$V_R(V)$			
Radial Leads	BF	CPM-83	63 ... 400	40 ... 200	1 nF ... 2.2 μ F	$\pm 5\%$ (E6 - E12)	5.08 (0.200)
		C83151				$\pm 10\%$ (E6 - E12)	
	BH	CPM-N	63 ... 400	40 ... 200	1 nF ... 2.2 μ F	$\pm 5\%$ (E6 - E12)	5.08 (0.200)
		C83151				$\pm 10\%$ (E6 - E12)	
	BT	CPM85	63 ... 630	40 ... 220	1 nF ... 22 μ F	$\pm 5\%$ (E6 - E12)	7.5 (0.295)
		C83151				$\pm 10\%$ (E6 - E12)	10.0 (0.394)
	BG	CPM85	63 ... 1,000	40 ... 250	1 nF ... 22 μ F	$\pm 5\%$ (E6 - E12)	15.0 (0.591)
C83151		$\pm 10\%$ (E6 - E12)				22.5 (0.886)	
BC / BD		250	-	0.47 μ F ... 2.2 μ F	$\pm 5\%$	27.5 (1.083)	
					$\pm 10\%$	15.0 (0.591)	
BO	CPM50	40 ... 400	25 ... 200	1 nF ... 22 μ F	$\pm 5\%$ (E6 - E12)	7.5 (0.295)	
	C83151				$\pm 10\%$ (E6 - E12)	10.0 (0.394)	
S4	CPM13	63 ... 400	40 ... 200	1 nF ... 10 μ F	$\pm 5\%$ (E6 - E12)	15.0 (0.591)	
	C83151				$\pm 10\%$ (E6 - E12)	27.5 (1.083)	
					$\pm 20\%$ (E6 - E12)	7.62 (0.300)	
					$\pm 10\%$ (E6 - E12)	10.16 (0.400)	
					$\pm 20\%$ (E6 - E12)	15.24 (0.600)	
						27.94 (1.100)	







Axial Leads	S8	CPM8	63 ... 400	40 ... 200	1 nF ... 10 μ F	$\pm 5\%$ (E6 - E12)	
		C83151				$\pm 10\%$ (E6 - E12)	
	SH	CPM8	63 ... 1,000	40 ... 250	1 nF ... 22 μ F	$\pm 5\%$ (E6 - E12)	
		C83151				$\pm 10\%$ (E6 - E12)	
	S9	CPM72	100 ... 630	40 ... 220	1 nF ... 10 μ F	$\pm 5\%$ (E6 - E12)	
C83151		$\pm 10\%$ (E6 - E12)					
SG	CPM72	63 ... 1,000	40 ... 250	1 nF ... 22 μ F	$\pm 5\%$ (E6 - E12)		
	C83151				$\pm 10\%$ (E6 - E12)		
ST		630 ... 10,000			100 pF ... 1.5 μ F	$\pm 5\%$ (E6 - E12)	
						$\pm 10\%$ (E6 - E12)	
						$\pm 20\%$ (E6 - E12)	

Metallized Polyester Film Dielectric Capacitors



HOW TO ORDER

Example of an order: how to order a CPM85 100 nF $\pm 10\%$ 100 V.

<p>BT07</p>  <p>Identification Code</p>	<p>4</p>  <p>Dielectric Class</p>	<p>E</p>  <p>Voltage Code</p>	<p>0104</p>  <p>Capacitance (EIA code)</p>	<p>K</p>  <p>Tolerance Code</p>	<p>--</p>  <p>Suffix</p>
<p>Radial Leads</p> <p>CPM83 BF 01 CPM83 BF 02 CPM83 BF 05 CPM83 BF 06 CPM83 BF 07 CPM-N BH 01 CPM-N BH 02 CPM-N BH 05 CPM-N BH 06 CPM-N BH 07 CPM85 BT 07 CPM85 BT 10 CPM85 BT 15 CPM85 BT 22 CPM85 BT 27 CPM85 BG 07 CPM85 BG 10 CPM85 BG 15 CPM85 BG 22 CPM85 BG 27 - BC 15 - BD 15 CPM50 BO 07 CPM50 BO 10 CPM50 BO 15 CPM50 BO 27 CPM13 S4 07 CPM13 S4 10 CPM13 S4 15 CPM13 S4 27</p>	<p>C = 25/40 V D = 50/63 V E = 100 V F = 160/200 V G = 250 V H = 275/300 V I = 400 V J = 500 V K = 600/630 V L = 1000 V M = 1600 V N = 2000 V P = 2500 V Q = 3000 V R = 4000 V S = 5000 V T = 6000/6300 V U = 8000 V V = 10 kV</p>	<p>Capacitance expressed by 2 significant figures 1st digit: 0 (zero) 2nd and 3rd digit: the 2 significant figures of the capacitance value 4th digit: - for values ≥ 10 pF and ≤ 990 μF: the number of zeros to be added to the capacitance values - for values ≥ 1 pF and ≤ 9.9 pF: the numerical 9 signifying that the capacitance value is to be multiplied by 0.1 - for values < 1 pF: the numerical 8 signifying that the capacitance value is to be multiplied by 0.01 Example: 1000 pF = 0102 8.2 pF = 0829 0.47 pF = 0478</p> <p>Capacitance expressed by 3 significant figures 1st, 2nd and 3rd digit: the 3 significant figures of the capacitance value 4th digit: - for values > 100 pF and ≤ 999 μF: the number of zeros to be added to the capacitance values - for values > 10 pF and < 100 pF: the numerical 9 signifying that the capacitance value is to be multiplied by 0.1 - for values > 1 pF and < 10 pF: the numerical 8 signifying that the capacitance value is to be multiplied by 0.1 Example: 196 pF = 1960 47.2 pF = 4729 8.28 pF = 8288</p>	<p>J = $\pm 5\%$ K = $\pm 10\%$ M = $\pm 20\%$</p>	<p>DA - DB - DC - DD: lead spacing 5.08 mm taped on reel or ammpack EN Radial types: lead spacing 7.5/10/15 mm taped on reel H=16.5 mm Axial type: (SG series only) Ammpack EP: Taped on reel H=18.5 mm (only for BG type) GA or GB: standard axial taped (S8, S9, ST types) -- Bulk</p>	
<p>Axial Leads</p> <p>CPM8 S8 10 CPM8 S8 14 CPM8 S8 18 CPM8 S8 31 CPM8 SH 13 CPM8 SH 18 CPM8 SH 25 CPM8 SH 30 CPM8 SH 40 CPM72 S9 10 CPM72 S9 14 CPM72 S9 18 CPM72 S9 27 CPM72 S9 31 CPM72 SG 13 CPM72 SG 18 CPM72 SG 25 CPM72 SG 30 CPM72 SG 40 - ST 22 - ST 36</p>					

APPLICATIONS

Non-inductive, self-healing, metallized polyester film capacitor. Insulated* thermoplastic casing, epoxy resin sealed with stand-offs*. Radial connections with a lead spacing of 5.08 mm.

* Flame retardant resin and case according to UL 94 VO.

Some examples of use:

Supply decoupling, filter, integrators, treatment of analog signals, rejection of line perturbations, etc.

STANDARDIZATION

Generic specifications:

CEI 384-1/CECC 30000/UTE 83100

Sectional specifications:

CEI 384-2/CECC 30400/UTE 83151

Complies with special specification:

CECC 30401-063

On the LNZ list:

Complies with type CPM-N

RAQ2 production, equivalent AQAP-4 of NATO

Schematic Cross Section

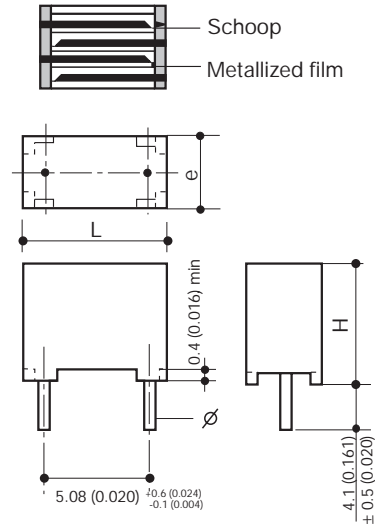

DIMENSIONS:

millimeters (inches)

Case	L max.	H max.	e max.	Ø ± 0.02	Observations
01	7.5 (0.295)	6.5 (0.256)	2.5 (0.098)	0.5 (0.020)	1nF ≤ C _R ≤ 220nF
02	7.5 (0.295)	8.0 (0.315)	3.2 (0.126)	0.5 (0.020)	12nF ≤ C _R ≤ 330nF
05	7.5 (0.295)	12.0 (0.472)	6.0 (0.236)	0.5 (0.020)	560nF ≤ C _R ≤ 2.2µF
06	7.5 (0.295)	9.6 (0.378)	6.0 (0.236)	0.5 (0.020)	47nF / 400V
07	7.5 (0.295)	8.0 (0.315)	5.0 (0.197)	0.5 (0.020)	27nF ≤ C _R ≤ 1µF

HOW TO ORDER

BF 01

Type

4

Class

D

Voltage

0104

Capacitance Value

K

Tolerance

--

Suffix

PERFORMANCE CHARACTERISTICS

Climatic category: 55/100/56 - Performance Class 2

Capacitance range: C_R 1 nF to 2.2 µF (E12)

Tolerances on C_R: ±5%, ±10%
(other values on request)

Nominal voltages: V_{R-} 63/100/250/400 V
V_{R-} 40/63/160/200 V

Category voltage: V_C = 0.8 V_{R-} at 100°C

Test voltage: V_e = 1.6 V_{R-}/2 s at 25°C

Tangent of loss angle: D.F. (see page 4)

Insulation resistance: IR (see page 5)

Max. voltage gradient: (dv/dt)_R (see page 5)

V _{R-}	63	100	250	400
(dv/dt) _R max	38	40	110	270

MARKING

100 nK 63

DC nominal voltage

Nominal capacitance

Tolerance (EIA code)

Logo

Example above: 63 V_{DC}, 100nF, ±10%

CAPACITANCE VALUES (C_R) AND NOMINAL VOLTAGES (V_R) vs CASE SIZE

Capacitance Range (C_R)	Reference			
	BF			
	V_{R+}/V_{R-}			
	63/40	100/63	250/160	400/200
1,000 pF	BF01	BF01	BF01	BF01
1,200	BF01	BF01	BF01	BF01
1,500	BF01	BF01	BF01	BF01
1,800	BF01	BF01	BF01	BF01
2,200 pF	BF01	BF01	BF01	BF01
2,700	BF01	BF01	BF01	BF01
3,300	BF01	BF01	BF01	BF01
3,900	BF01	BF01	BF01	BF01
4,700 pF	BF01	BF01	BF01	BF01
5,600	BF01	BF01	BF01	BF01
6,800	BF01	BF01	BF01	BF01
8,200	BF01	BF01	BF01	BF01
10,000 pF	BF01	BF01	BF01	BF01
12,000	BF01	BF01	BF01	BF02
15,000	BF01	BF01	BF01	BF02
18,000	BF01	BF01	BF01	BF02
22,000	BF01	BF01	BF01	BF02
27,000	BF01	BF01	BF01	BF07
33,000	BF01	BF01	BF02	BF07
39,000	BF01	BF01	BF02	BF07
47,000 pF	BF01	BF01	BF02	BF06
56,000	BF01	BF01	BF07	
68,000	BF01	BF01	BF07	
82,000	BF01	BF01	BF07	
100 nF	BF01	BF01	BF07	
120	BF01	BF01		
150	BF01	BF01		
180	BF01	BF07		
220 nF	BF01	BF07		
270	BF02	BF07		
330	BF02	BF07		
390	BF07/BF02*	BF07		
470 nF	BF07/BF02*	BF07		
560	BF07	BF05		
680	BF07	BF05		
820	BF07	BF05		
1 μ F	BF07	BF05		
1.5 μ F	BF05			
2.2 μ F	BF05**			

* Upon request

** Upon request & only available 50 V (V_R)

APPLICATIONS

Non-inductive, self-healing, metallized polyester film capacitor. Insulated* thermoplastic casing, epoxy resin sealed with stand-offs*. Radial connections with a lead spacing of 5.08 mm.

* Flame retardant case according to UL 94 VO.

Some examples of use:

Supply decoupling, filter, integrators, treatment of analog signals, rejection of line perturbations, etc... Specifically designed for working in severe environmental conditions such as automotive applications: engine control, multiplexing system, etc.

STANDARDIZATION

Generic specifications:

CEI 384-1/CECC 30000/UTE 83100

Sectional specifications:

CEI 384-2/CECC 30400/UTE 83151

On the LNZ list:

Complies with type CPM-N

RAQ2 production, equivalent AQAP-4 of NATO

Schematic Cross Section

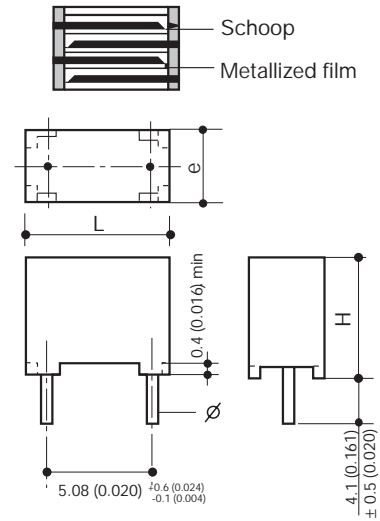

DIMENSIONS:

millimeters (inches)

Case	L max.	H max.	e max.	$\phi \pm 0.02$	Observations
01	7.5 (0.295)	6.5 (0.256)	2.5 (0.098)	0.5 (0.020)	$1\text{nF} \leq C_R \leq 220\text{nF}$
02	7.5 (0.295)	8.0 (0.315)	3.2 (0.126)	0.5 (0.020)	$5.6\text{nF} \leq C_R \leq 330\text{nF}$
05	7.5 (0.295)	12.0 (0.472)	6.0 (0.236)	0.5 (0.020)	$39\text{nF} \leq C_R \leq 2.2\mu\text{F}$
06	7.5 (0.295)	9.6 (0.378)	6.0 (0.236)	0.5 (0.020)	$18\text{nF} \leq C_R \leq 100\text{nF}$
07	7.5 (0.295)	8.0 (0.315)	5.0 (0.197)	0.5 (0.020)	$8.2\text{nF} \leq C_R \leq 1\mu\text{F}$

HOW TO ORDER

BH 01

Type

4

Class

D

Voltage

0104

Capacitance Value

K

Tolerance

--

Suffix

PERFORMANCE CHARACTERISTICS

Climatic category: 55/125/56 - Performance Class 2

Capacitance range: C_R 1 nF to 2.2 μF (E12)

Tolerances on C_R : $\pm 5\%$, $\pm 10\%$
(other values on request)

Nominal voltages: V_{R-} 63/100/250/400 V
 V_{R-} 40/63/160/200 V

Category voltage: $V_C = 0.8 V_{R-}$ at 100°C/0.5 V_{R-}
at 125°C

Test voltage: $V_e = 1.6 V_{R-}/2$ s at 25°C

Tangent of loss angle: D.F. (see page 4)

Insulation resistance: IR (see page 5)

Max. voltage gradient: $(dv/dt)_R$ (see page 5)

Life test: $\Delta C/C \leq 5\%$ after 125°C/1000 h/0.5 V_{R-}

Thermal shock: -55/+125°C/time cycle 1hr/500 cycles $\Delta C/C \leq 10\%$, D.F. 1kHz $\leq 1\%$

Humidity test: 85°C/85% R.H./1000 h $\Delta C/C \leq 10\%$

MARKING

D 104 K E 49

DC nominal voltage

Nominal capacitance (EIA code)

Tolerance (EIA code)

Logo

Lot number

Example above: 63 V_{DC} , 100nF, $\pm 10\%$

V_{R-}	63	100	250	400
$(dv/dt)_R$ max	38	40	110	270

CAPACITANCE VALUES (C_R) AND NOMINAL VOLTAGES (V_R) vs CASE SIZE

Capacitance Range (C_R)	Reference			
	BH			
	V_{R+}/V_{R-}			
	63/40	100/63	250/160	400/200
1,000 pF	BH01	BH01	BH01	BH01
1,200	BH01	BH01	BH01	BH01
1,500	BH01	BH01	BH01	BH01
1,800	BH01	BH01	BH01	BH01
2,200 pF	BH01	BH01	BH01	BH01
2,700	BH01	BH01	BH01	BH01
3,300	BH01	BH01	BH01	BH01
3,900	BH01	BH01	BH01	BH01
4,700 pF	BH01	BH01	BH01	BH01
5,600	BH01	BH01	BH01	BH02
6,800	BH01	BH01	BH01	BH02
8,200	BH01	BH01	BH01	BH07
10,000 pF	BH01	BH01	BH01	BH07
12,000	BH01	BH01	BH01	BH07
15,000	BH01	BH01	BH01	BH07
18,000	BH01	BH01	BH01/BH02*	BH06/BH05*
22,000	BH01	BH01	BH02	BH06/BH05*
27,000	BH01	BH01	BH02	BH06/BH05*
33,000	BH01	BH01	BH02	BH06/BH05*
39,000	BH01	BH01	BH07	BH05
47,000 pF	BH01	BH01	BH07	BH05
56,000	BH01	BH01	BH07	
68,000	BH01	BH01	BH07	
82,000	BH01	BH01	BH06/BH05*	
100 nF	BH01	BH01	BH06/BH05*	
120	BH01	BH01/BH07*	BH05	
150	BH01	BH01/BH07*	BH05	
180	BH01	BH02/BH07*		
220 nF	BH01/BH02*	BH02/BH07*		
270	BH02	BH07		
330	BH02	BH07		
390	BH07	BH07/BH05*		
470 nF	BH07	BH05		
560	BH07	BH05		
680	BH07/BH06*	BH05		
820	BH07/BH06*	BH05		
1 μ F	BH07/BH06*	BH05		
1.5 μ F	BH05			
2.2 μ F	BH05**			

** ($V_R = 50$ V)

* Upon request

CHARACTERISTICS CURVES

Influence of the frequency on the impedance (room temperature).

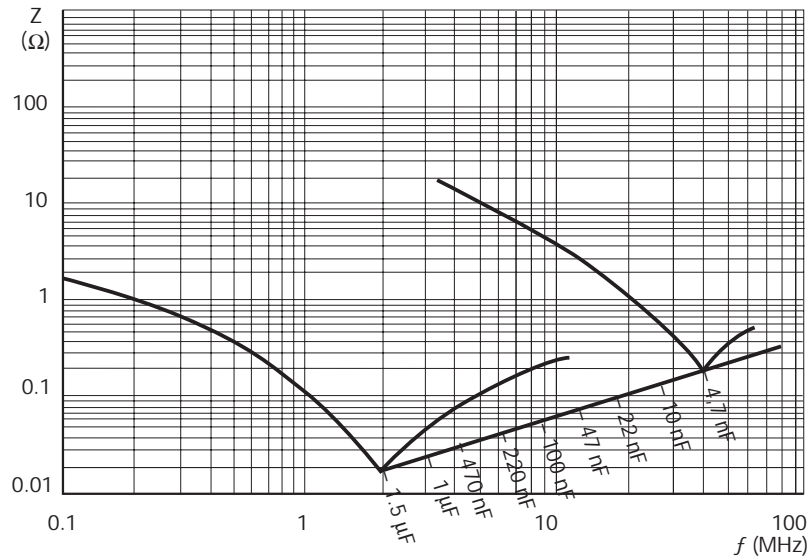

Nominal RMS voltage vs. frequency (room temperature) allowing a 10°C increase of the external temperature of the box.

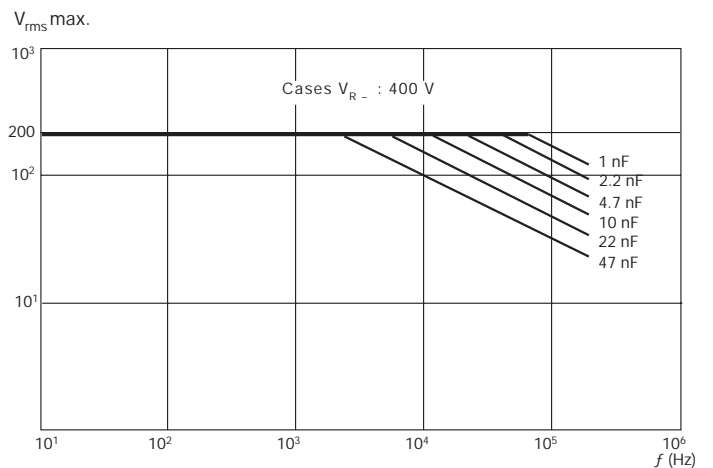
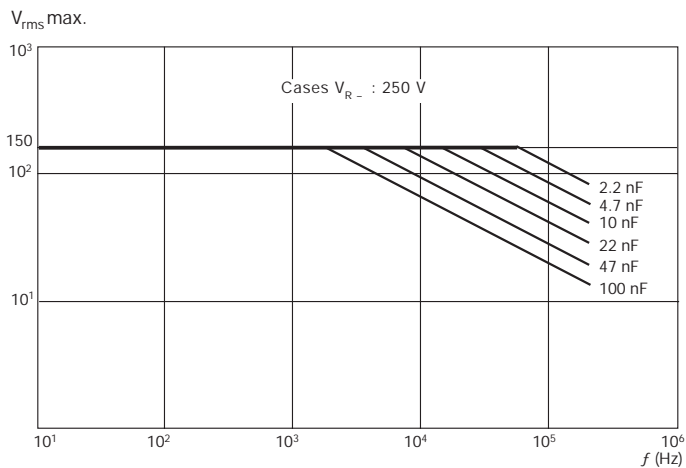
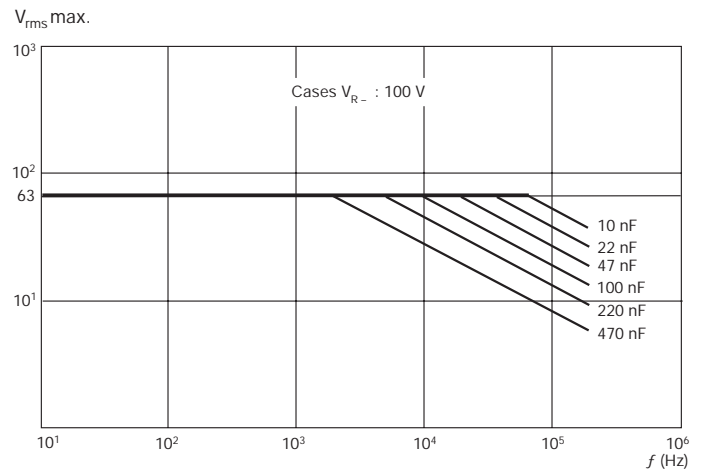
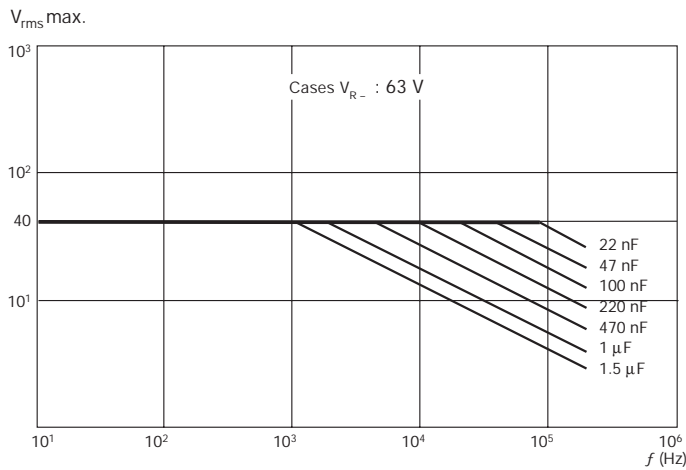

CHARACTERISTICS OF THE REEL –

Suffixes to be used (see page 7) millimeters (inches)

	Taping Suffixes			
	DA	DB	DC	DD
H	16.5 ± 0.3 (0.650 ± 0.012)		19.5 ± 0.5 (0.768 ± 0.020)	
REEL	-	PANASERT	-	AVISERT
AMMOPACK	PANASERT	-	AVISERT	-

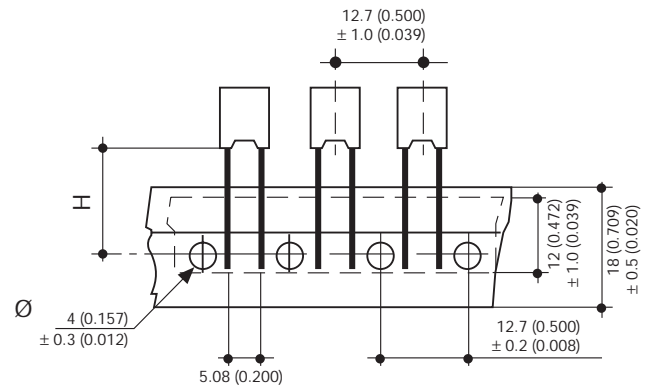

Thermo adhesive tape ▲

(Other sizes according to standard CEI : 286-2)
Dimensions millimeters (inches)

PACKAGING

Case	Quantity			
	Reel	Ammopack	Bulk	
			USA Std.	Europe & Asia Std.
01	2500	2500	1000	5000
02	1800	2000	1000	3800
05	900	1100	1000	1500
06	900	1100	1000	1500
07	1200	1250	1000	2500

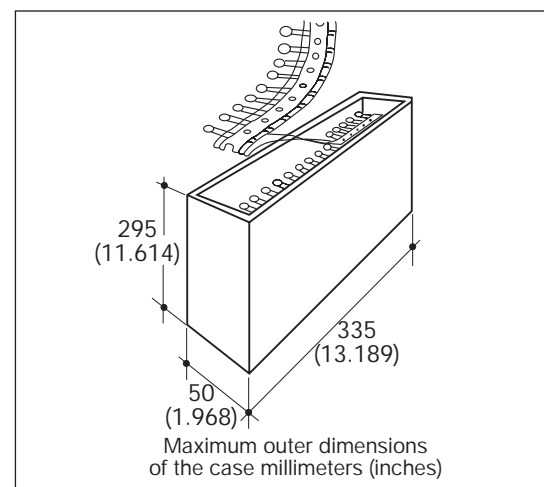
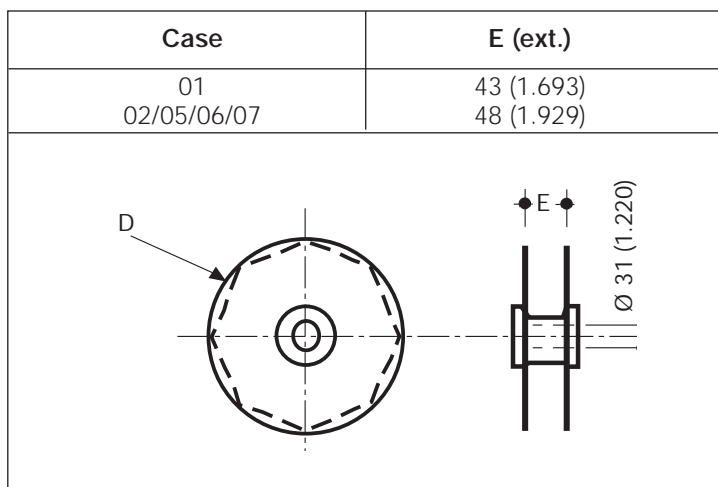

BT 07/10/15/22/27

CPM-85 — 7.5/10/15/22.5/27.5 Radial Leads

63/100/160/250/400/630 V-



APPLICATIONS

Non-inductive, self-healing, metallized polyester film capacitor. Insulated* thermoplastic casing, epoxy resin sealed with stand-offs*. Radial connections.

* Flame retardant resin and case according to UL 94 VO.

Some examples of use:

Supply decoupling, filter, integrators, treatment of analog signals, rejection of line perturbations, etc.

STANDARDIZATION

Generic specifications:

CEI 384-1/CECC 30000/UTE 83100

Sectional specifications:

CEI 384-2/CECC 30400/UTE 83151

On the LNZ list:

Complies with type CPM85 – CPM-R

Schematic Cross Section

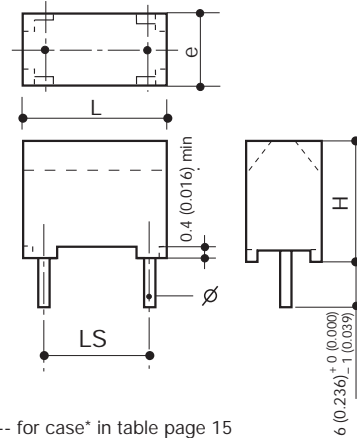
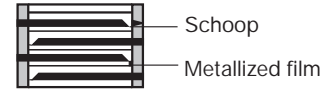

---- for case* in table page 15

DIMENSIONS:

Size Code	L max.	H max.	e max.	LS ±0.4	ø ^{+10%} _{-0.05}	Observations
07	9.25 ... 10.1 (0.364 ... 0.398)	8.0 ... 12.0 (0.315 ... 0.472)	3.25 ... 6.0 (0.128 ... 0.236)	7.5 (0.295)	0.6 (0.024)	1nF ≤ C _R ≤ 1μF
10	12.5 (0.492)	9.0 ... 13.5 (0.354 ... 0.531)	4.0 / 5.0 (0.157 / 0.197)	10.0 (0.394)	0.6 (0.024)	4.7nF ≤ C _R ≤ 470nF
15	17.5 (0.689)	10.5 ... 14.5 (0.413 ... 0.571)	5.0 ... 8.5 (0.197 ... 0.335)	15.0 (0.591)	0.8 (0.031)	33nF ≤ C _R ≤ 2.2μF
22	26.25 (1.033)	15.0 ... 19.5 (0.591 ... 0.768)	7.5 / 10.0 (0.295 / 0.394)	22.5 (0.886)	0.8 (0.031)	100nF ≤ C _R ≤ 6.8μF
27	31.25 (1.230)	19.5 ... 30.0 (0.768 ... 1.181)	10.0 ... 17.5 (0.394 ... 0.689)	27.5 (1.083)	0.8 (0.031)	330nF ≤ C _R ≤ 22μF

HOW TO ORDER

BT 10
Type

4
Class

G
Voltage

0104
Capacitance Value

K
Tolerance

--
Suffix
Tape and Reel
See page 27

PERFORMANCE CHARACTERISTICS

Climatic category:	55/100/56 - Performance Class 1
Capacitance range:	C _R 1 nF to 2.2 μF (E6)
Tolerances on C _R :	±5%, ±10%, ±20% (other values on request)
Nominal voltages:	V _{R-} 63/100/160/250/400/630 V V _{R-} 40/63/80/160/200/220 V
Category voltage:	V _C = 0.8 V _{R-} at 100°C
Test voltage:	V _e = 1.6 V _{R-} /2 s at 25°C
Tangent of loss angle:	D.F. (see page 4)
Insulation resistance:	IR (see page 5)
Max. voltage gradient:	(dv/dt) _R (see page 5)

Size	V _{R-} / dv/dt V/μs					
	63	100	160	250	400	630
07	35	50	-	72	150	300
10	18	28	30	45	90	180
15	12	15	20	30	55	100
22	4	5	-	9	12	20
27	3	4	6	7	10	15

MARKING

Logo
Nominal capacitance
Tolerance (EIA code)
DC nominal voltage

**NOMINAL VOLTAGE (V_R) AND CAPACITANCE VALUES (C_R)
DEPENDING ON THE DIMENSIONS**

S i z e	C a s e	DIMENSIONS: millimeters (inches)					Reference					
							BT					
		Max L	Max H	Max e	\varnothing ^{+10%} _{-0.05}	LS ± 0.4	V_{R+}/V_{R-}					
							63/40	100/63	160/80	250/160	400/200	630/220
Range of Capacitance (C_R min. ... max.)												
07	1	9.25 (0.364)	8.0 (0.315)	3.25 (0.128)	0.6 (0.024)	7.5 (0.295)	68 nF ... 220 nF	22 nF ... 150 nF	-	6.8 nF ... 47 nF	1 nF ... 22 nF	1 nF ... 3.3 nF
	2	10.1 (0.398)	10.0 (0.394)	5.0 (0.197)	0.6 (0.024)		330 nF/470 nF	220 nF/330 nF	-	68 nF ... 100 nF	-	4.7 nF/6.8 nF
	C	10.1 (0.398)	11.0 (0.433)	5.0 (0.197)	0.6 (0.024)		680 nF	-	-	-	-	10 nF
	D	10.1 (0.398)	12.0 (0.472)	6.0 (0.236)	0.6 (0.024)		1 μ F	-	-	150 nF	33 nF ... 47 nF	15 nF
10	EO	12.5 (0.492)	9.0 (0.354)	4.0 (0.157)	0.6 (0.024)	10.0 (0.394)	220 nF ... 470 nF	100 nF ... 220 nF	100 nF ... 220 nF	33 nF ... 100 nF	6.8 nF ... 33 nF	-
	4	12.5 (0.492)	10.0 (0.394)	5.0 (0.197)	0.6 (0.024)		-	-	-	-	47 nF	4.7 nF/22 nF
15	6	17.5 (0.689)	10.5 (0.413)	5.0 (0.197)	0.8 (0.031)	15.0 (0.591)	680 nF ... 1 μ F	150 nF ... 1 μ F	330 nF/470 nF	68 nF ... 220 nF	47 nF/68 nF	33 nF
	7	17.5 (0.689)	13.5 (0.531)	5.0 (0.197)	0.8 (0.031)		-	-	-	-	100 nF	-
	IO	17.5 (0.689)	12.0 (0.472)	6.0 (0.236)	0.8 (0.031)		2.2 μ F	-	680 nF	330 nF	-	-
	8	17.5 (0.689)	13.5 (0.531)	6.25 (0.246)	0.8 (0.031)		-	-	1 μ F	390 nF	150 nF	47 nF
	9	17.5 (0.689)	14.5 (0.571)	8.5 (0.335)	0.8 (0.031)		-	-	2.2 μ F	-	-	68 nF
22	11	26.25 (1.033)	15.0 (0.591)	7.5 (0.295)	0.8 (0.031)	22.5 (0.886)	-	1.5 μ F	-	470 nF/680 nF	220 nF	100 nF
	12	26.25 (1.033)	17.5 (0.689)	7.5 (0.295)	0.8 (0.031)		3.3 μ F	2.2 μ F	-	-	330 nF	150 nF
	13	26.25 (1.033)	19.5 (0.768)	10.0 (0.394)	0.8 (0.031)		4.7 μ F/6.8 μ F	3.3 μ F	-	1 μ F/1.5 μ F	470 nF	220 nF
27	16	31.25 (1.230)	19.5 (0.768)	10.0 (0.394)	0.8 (0.031)	27.5 (1.083)	6.8 μ F	4.7 μ F	3.3 μ F	1.5 μ F	470 nF 680 nF	330 nF
	17*	31.25 (1.230)	22.5 (0.886)	12.5 (0.492)	0.8 (0.031)		10 μ F	6.8 μ F	-	2.2 μ F	1 μ F	470 nF
	18*	31.25 (1.230)	26.0 (1.024)	15.0 (0.591)	0.8 (0.031)		15 μ F	10 μ F	-	3.3 μ F	1.5 μ F	680 nF
	19*	31.25 (1.230)	30.0 (1.181)	17.5 (0.689)	0.8 (0.031)		22 μ F	-	-	4.7 μ F	2.2 μ F	1 μ F

CHARACTERISTIC CURVES

Influence of the frequency on the impedance (room temperature)

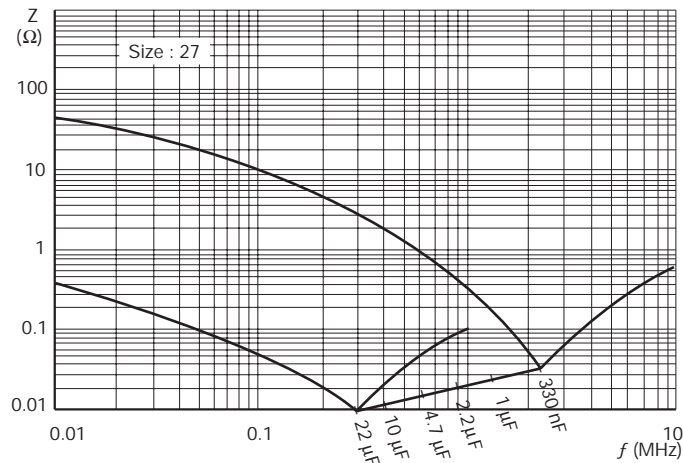
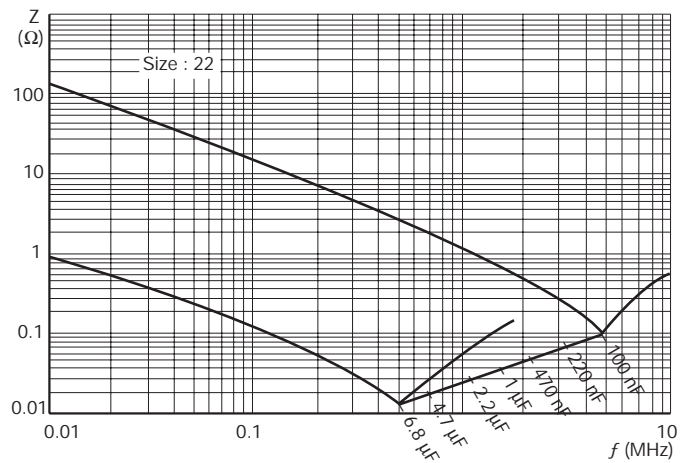
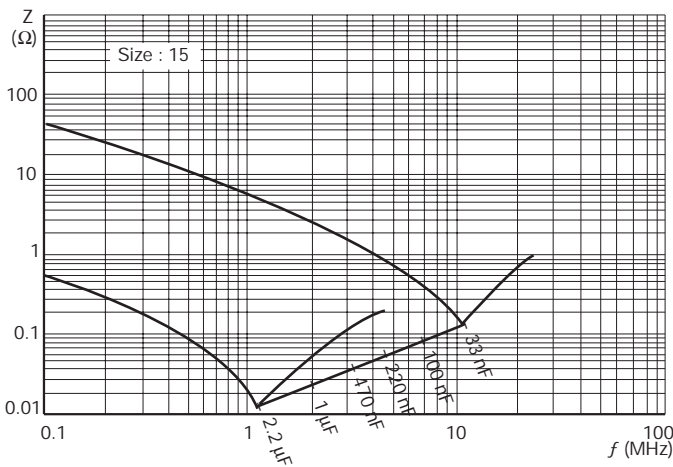
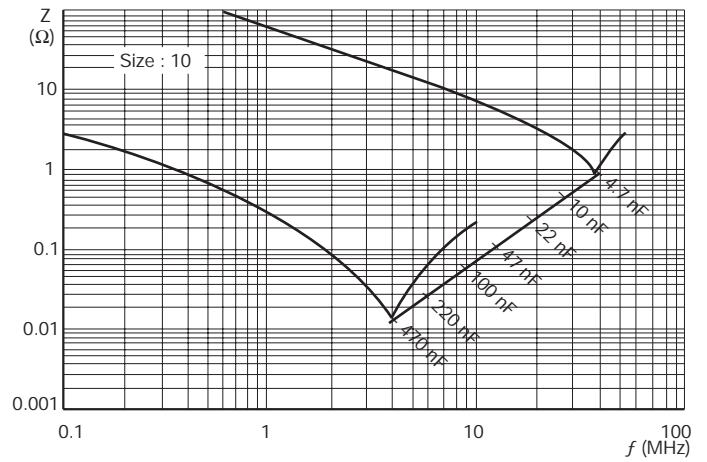
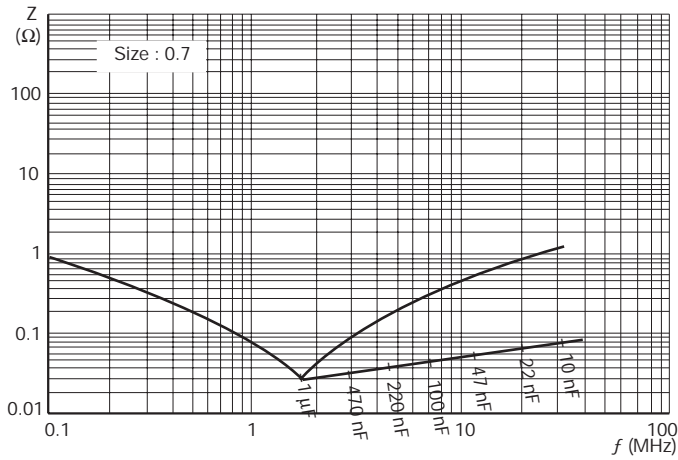

CHARACTERISTIC CURVES

Nominal RMS voltage vs. frequency (room temperature) allowing a 10°C increase of the external temperature of the box.

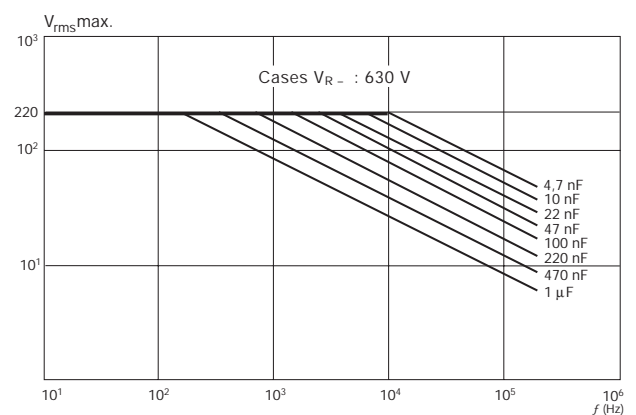
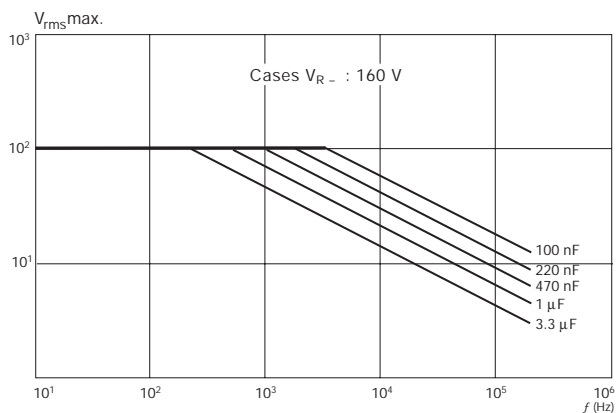
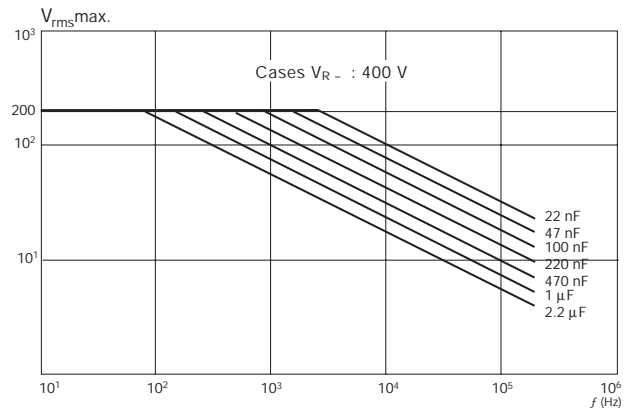
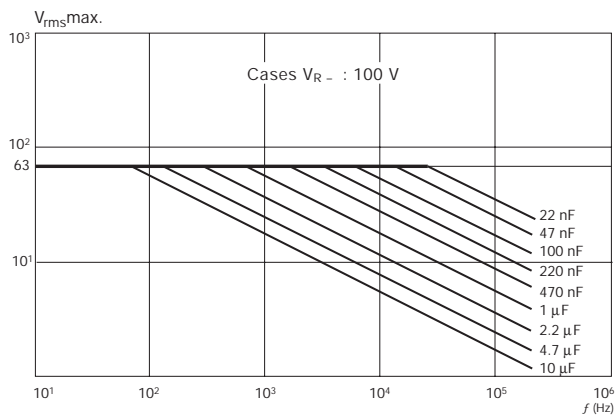
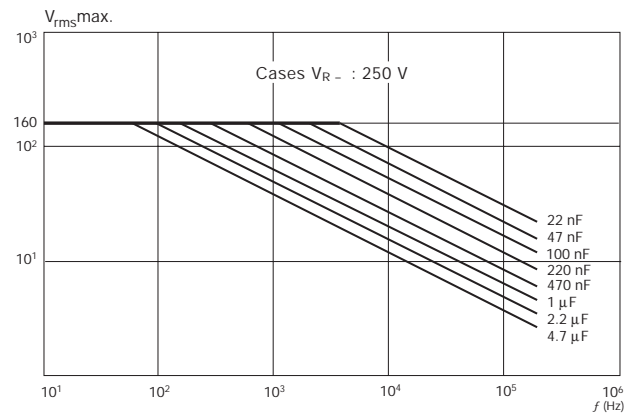
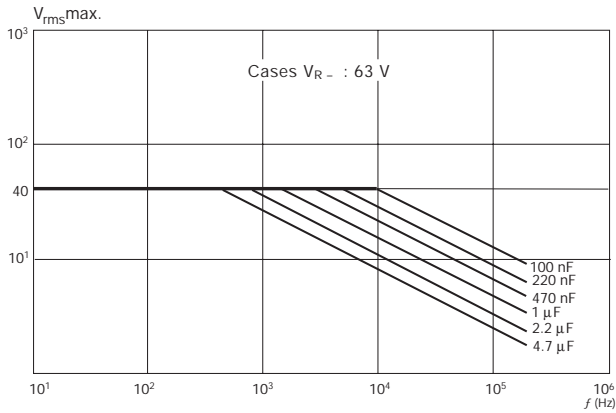

BG 07/10/15/22/27

CPM-85 – 7.5/10/15/22.5/27.5

Boxed Metallized Polyester Capacitor



APPLICATIONS

Non-inductive, self-healing, metallized polyester film capacitor. Insulated* thermoplastic casing, epoxy resin sealed with stand-offs*. Radial connections.

* Flame retardant resin and case according to UL 94 VO .

Some examples of use:

Supply decoupling, filter, integrators, treatment of analog-signals, rejection of line perturbations, etc.

STANDARDIZATION

Generic specifications:

CEI 384-1/CECC 30000/UTE 83100

Sectional specifications:

CEI 384-2/CECC 30400/UTE 83151

On the LNZ list:

Complies with type CPM85 – CPM-R

MARKING

Logo - Voltage
Capacitance Tolerance

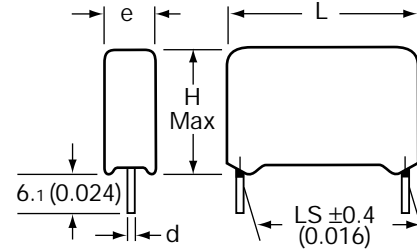

millimeters (inches)

Lead Spacing (LS)	Diameter Ø
7.5 (0.295)	0.6 (0.024)
10 (0.394)	0.6 ⁽¹⁾ (0.024) / 0.8 (0.031)
> 10 (0.394)	0.8 (0.031)

(1): 0.6 (0.024) for capacitors with $e \leq 6$ (0.024)

PERFORMANCE CHARACTERISTICS

Protection:	Plastic casing, epoxy resin sealed flame retardant case (UL 94 VO)
Temperature range:	-55°C to +100°C with voltage derating of 1.25%/°C between 85°C and 100°C
Climatic category:	55/100/56
Voltage range:	63 VDC to 1000 VDC
Capacitance range:	1 nF to 22 µF
Tolerances on C_R :	±5%, ±10%, ±20%
Test voltage:	1.6 $V_n/2$ s
Insulation resistance:	
Measurement condition:	
Temperature:	25°C ± 5°C
Duration:	1 minute
Measurement Voltage:	100 V for $V_n \geq 100$ V 50 V for $V_n < 100$ V

Requirements:

For $U_n \leq 100$ V:	$C \leq 0.33 \mu\text{F} \geq 15,000 \text{ M}\Omega$ $C > 0.33 \mu\text{F} \geq 5,000 \text{ S}$
For $U_n > 100$ V:	$C \leq 0.33 \mu\text{F} \geq 30,000 \text{ M}\Omega$ $C > 0.33 \mu\text{F} \geq 10,000 \text{ S}$

Tangent of loss angle:

LIMIT VALUES

	$C \leq 0.1 \mu\text{F}$	$0.1 \mu\text{F} < C \leq 1 \mu\text{F}$	$C > 1 \mu\text{F}$
1 kHz	8×10^{-3}	8×10^{-3}	10×10^{-3}
10 kHz	15×10^{-3}	15×10^{-3}	
100 Hz	30×10^{-3}		

HOW TO ORDER

BG 10



Type

Pitch 10mm = 10
Pitch 15mm = 15
Pitch 22.5mm = 22
Pitch 27.5mm = 27

4



Class

G



Voltage

0104



Capacitance Value

K



Tolerance

--



Suffix

Range

millimeters (inches)

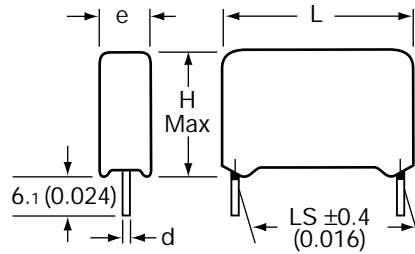

Capacitance	63 V DC / 40 V AC				100 V DC / 63 V AC				250 V DC / 160 V AC				
	e	H	L	LS	e	H	L	LS	e	H	L	LS	
0.01 μF													
0.01 μF									2.5 (0.098)	7.5 (0.295)	10.0 (0.394)	7.5 (0.295)	
0.015 μF													
0.015 μF									2.5 (0.098)	7.5 (0.295)	10.0 (0.394)	7.5 (0.295)	
0.022 μF													
0.022 μF					2.5 (0.098)	7.0 (0.276)	10.0 (0.394)	7.5 (0.295)	3.0 (0.118)	8.6 (0.339)	10.0 (0.394)	7.5 (0.295)	
0.033 μF									4.0 (0.157)	9.0 (0.354)	10.0 (0.394)	7.5 (0.295)	
0.033 μF					3.0 (0.118)	8.6 (0.339)	10.0 (0.394)	7.5 (0.295)	4.0 (0.157)	9.0 (0.354)	13.0 (0.512)	10.0 (0.394)	
0.047 μF													
0.047 μF									4.0 (0.157)	9.0 (0.354)	10.0 (0.394)	7.5 (0.295)	
0.047 μF					3.0 (0.118)	8.6 (0.339)	10.0 (0.394)	7.5 (0.295)	9.0 (0.354)	9.0 (0.354)	13.0 (0.512)	10.0 (0.394)	
0.068 μF													
0.068 μF					3.0 (0.118)	8.6 (0.339)	10.0 (0.394)	7.5 (0.295)	5.0 (0.197)	11.0 (0.433)	10.0 (0.394)	7.5 (0.295)	
0.068 μF					4.0 (0.157)	9.0 (0.354)	13.0 (0.512)	10.0 (0.394)	4.0 (0.157)	9.0 (0.354)	13.0 (0.512)	10.0 (0.394)	
0.1 μF									5.0 (0.197)	11.0 (0.433)	10.0 (0.394)	7.5 (0.295)	
0.1 μF					4.0 (0.157)	9.0 (0.354)	10.0 (0.394)	7.5 (0.295)	4.0 (0.157)	9.0 (0.354)	13.0 (0.512)	10.0 (0.394)	
0.1 μF					4.0 (0.157)	9.0 (0.354)	13.0 (0.512)	10.0 (0.394)	5.5 (0.216)	10.5 (0.413)	18.0 (0.709)	15.0 (0.591)	
0.15 μF									6.0 (0.236)	12.0 (0.472)	10.4 (0.409)	7.5 (0.295)	
0.15 μF					4.0 (0.157)	9.0 (0.354)	10.0 (0.394)	7.5 (0.295)	4.0 (0.157)	9.0 (0.354)	13.0 (0.512)	10.0 (0.394)	
0.15 μF	2.5 (0.098)	7.0 (0.276)	10.0 (0.394)	7.5 (0.295)	4.0 (0.157)	9.0 (0.354)	13.0 (0.512)	10.0 (0.394)	5.5 (0.216)	10.5 (0.413)	18.0 (0.709)	15.0 (0.591)	
0.22 μF													
0.22 μF					5.0 (0.197)	11.0 (0.433)	10.0 (0.394)	7.5 (0.295)	5.0 (0.197)	11.0 (0.433)	13.0 (0.512)	10.0 (0.394)	
0.22 μF	4.0 (0.157)	9.0 (0.354)	10.0 (0.394)	7.5 (0.295)	4.0 (0.157)	9.0 (0.354)	13.0 (0.512)	10.0 (0.394)	5.5 (0.216)	10.5 (0.413)	18.0 (0.709)	15.0 (0.591)	
0.33 μF									5.0 (0.197)	11.0 (0.433)	10.0 (0.394)	7.5 (0.295)	
0.33 μF	4.0 (0.157)	9.0 (0.354)	10.0 (0.394)	7.5 (0.295)	5.0 (0.197)	11.0 (0.433)	13.0 (0.512)	10.0 (0.394)	6.0 (0.236)	11.0 (0.433)	13.0 (0.512)	10.0 (0.394)	
0.33 μF	4.0 (0.157)	9.0 (0.354)	13.0 (0.512)	10.0 (0.394)	5.5 (0.216)	10.5 (0.413)	18.0 (0.709)	15.0 (0.591)	5.5 (0.216)	10.5 (0.413)	18.0 (0.709)	15.0 (0.591)	
0.47 μF									6.0 (0.236)	12.0 (0.472)	10.4 (0.409)	7.5 (0.295)	
0.47 μF	5.0 (0.197)	11.0 (0.433)	10.0 (0.394)	7.5 (0.295)	5.0 (0.197)	11.0 (0.433)	13.0 (0.512)	10.0 (0.394)	5.5 (0.216)	10.5 (0.413)	18.0 (0.709)	15.0 (0.591)	
0.47 μF	4.0 (0.157)	9.0 (0.354)	13.0 (0.512)	10.0 (0.394)	5.5 (0.216)	10.5 (0.413)	18.0 (0.709)	15.0 (0.591)	7.0 (0.276)	15.0 (0.591)	25.5 (1.004)	22.5 (0.886)	
0.68 μF													
0.68 μF	5.0 (0.197)	11.0 (0.433)	13.0 (0.512)	10.0 (0.394)	6.0 (0.236)	11.0 (0.433)	13.0 (0.512)	10.0 (0.394)	7.0 (0.276)	12.5 (0.492)	18.0 (0.709)	15.0 (0.591)	
0.68 μF	5.5 (0.216)	10.5 (0.413)	18.0 (0.709)	15.0 (0.591)	5.5 (0.216)	10.5 (0.413)	18.0 (0.709)	15.0 (0.591)	7.0 (0.276)	15.0 (0.591)	25.5 (1.004)	22.5 (0.886)	
1 μF													
1 μF	6.0 (0.236)	12.0 (0.472)	10.4 (0.409)	7.5 (0.295)									
1 μF	5.0 (0.197)	11.0 (0.433)	13.0 (0.512)	10.0 (0.394)	6.0 (0.236)	11.0 (0.433)	13.0 (0.512)	10.0 (0.394)	9.0 (0.354)	14.5 (0.571)	18.0 (0.709)	15.0 (0.591)	
1 μF	5.5 (0.216)	10.5 (0.413)	18.0 (0.709)	15.0 (0.591)	5.5 (0.216)	10.5 (0.413)	18.0 (0.709)	15.0 (0.591)	7.0 (0.276)	15.0 (0.591)	25.5 (1.004)	22.5 (0.886)	
1.5 μF													
1.5 μF	6.0 (0.236)	11.0 (0.433)	13.0 (0.512)	10.0 (0.394)	7.0 (0.276)	12.5 (0.492)	18.0 (0.709)	15.0 (0.591)	8.5 (0.335)	16.5 (0.650)	25.5 (1.004)	22.5 (0.886)	
1.5 μF	5.5 (0.216)	10.5 (0.413)	18.0 (0.709)	15.0 (0.591)	7.0 (0.276)	15.0 (0.591)	25.5 (1.004)	22.5 (0.886)	11.0 (0.433)	20.0 (0.787)	32.0 (1.260)	27.5 (1.083)	
2.2 μF													
2.2 μF	7.0 (0.276)	14.0 (0.551)	13.0 (0.512)	10.0 (0.394)	7.0 (0.276)	14.0 (0.551)	18.0 (0.709)	15.0 (0.591)	10.5 (0.413)	19.5 (0.768)	25.5 (1.004)	22.5 (0.886)	
2.2 μF	7.0 (0.276)	12.5 (0.492)	18.0 (0.709)	15.0 (0.591)	7.0 (0.276)	15.0 (0.591)	25.5 (1.004)	22.5 (0.886)	11.0 (0.433)	20.0 (0.787)	32.0 (1.260)	27.5 (1.083)	
3.3 μF													
3.3 μF	7.0 (0.276)	12.5 (0.492)	18.0 (0.709)	15.0 (0.591)	9.0 (0.354)	14.5 (0.571)	18.0 (0.709)	15.0 (0.591)					
3.3 μF	7.0 (0.276)	15.0 (0.591)	25.5 (1.004)	22.5 (0.886)	8.5 (0.335)	16.5 (0.650)	25.5 (1.004)	22.5 (0.886)	11.0 (0.433)	20.0 (0.787)	32.0 (1.260)	27.5 (1.083)	
4.7 μF													
4.7 μF	9.0 (0.354)	14.5 (0.571)	18.0 (0.709)	15.0 (0.591)	8.5 (0.335)	16.5 (0.650)	25.5 (1.004)	22.5 (0.886)					
4.7 μF	8.5 (0.335)	16.5 (0.650)	25.5 (1.004)	22.5 (0.886)	11.0 (0.433)	20.0 (0.787)	32.0 (1.260)	27.5 (1.083)	14.0 (0.551)	25.0 (0.984)	32.0 (1.260)	27.5 (1.083)	
6.8 μF													
6.8 μF					10.5 (0.413)	19.5 (0.768)	25.5 (1.004)	22.5 (0.886)					
6.8 μF	8.5 (0.335)	16.5 (0.650)	25.5 (1.004)	22.5 (0.886)	11.0 (0.433)	20.0 (0.787)	32.0 (1.260)	27.5 (1.083)					
10 μF													
10 μF	10.5 (0.413)	19.5 (0.768)	25.5 (1.004)	22.5 (0.886)									
10 μF	11.0 (0.433)	20.0 (0.787)	32.0 (1.260)	27.5 (1.083)	11.0 (0.433)	20.0 (0.787)	32.0 (1.260)	27.5 (1.083)					
15 μF													
15 μF	14.0 (0.551)	25.0 (0.984)	32.0 (1.260)	27.5 (1.083)									
22 μF													
22 μF	14.0 (0.551)	25.0 (0.984)	32.0 (1.260)	27.5 (1.083)									

Range

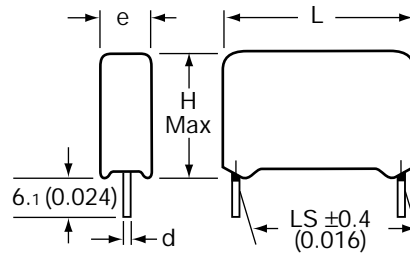

millimeters (inches)

Capacitance	400 V DC / 200 V AC				630 V DC / 220 V AC				1000 V DC / 250 V AC			
	e	H	L	LS	e	H	L	LS	e	H	L	LS
1 nF					2.5 (0.098)	7.0 (0.276)	10.0 (0.394)	7.5 (0.295)	4.0 (0.157)	9.0 (0.354)	13.0 (0.512)	10.0 (0.394)
1.5 nF												
1.5 nF					2.5 (0.098)	7.0 (0.276)	10.0 (0.394)	7.5 (0.295)	4.0 (0.157)	9.0 (0.354)	13.0 (0.512)	10.0 (0.394)
2.2 nF												
2.2 nF					3.0 (0.118)	8.6 (0.339)	10.0 (0.394)	7.5 (0.295)	4.0 (0.157)	9.0 (0.354)	13.0 (0.512)	10.0 (0.394)
3.3 nF												
3.3 nF					3.0 (0.118)	8.6 (0.339)	10.0 (0.394)	7.5 (0.295)	4.0 (0.157)	9.0 (0.354)	13.0 (0.512)	10.0 (0.394)
4.7 nF					4.0 (0.157)	9.0 (0.354)	10.0 (0.394)	7.5 (0.295)				
4.7 nF	2.5 (0.098)	7.0 (0.276)	10.0 (0.394)	7.5 (0.295)	4.0 (0.157)	9.0 (0.354)	13.0 (0.512)	10.0 (0.394)	4.0 (0.157)	9.0 (0.354)	13.0 (0.512)	10.0 (0.394)
6.8 nF					4.0 (0.157)	9.0 (0.354)	10.0 (0.394)	7.5 (0.295)				
6.8 nF	3.0 (0.118)	8.6 (0.339)	10.0 (0.394)	7.5 (0.295)	4.0 (0.157)	9.0 (0.354)	13.0 (0.512)	10.0 (0.394)	6.0 (0.236)	11.0 (0.433)	13.0 (0.512)	10.0 (0.394)
0.01 µF					5.0 (0.197)	11.0 (0.433)	10.0 (0.394)	7.5 (0.295)				
0.01 µF	4.0 (0.157)	9.0 (0.354)	10.0 (0.394)	7.5 (0.295)	4.0 (0.157)	9.0 (0.354)	13.0 (0.512)	10.0 (0.394)	5.5 (0.216)	10.5 (0.413)	18.0 (0.709)	15.0 (0.591)
0.015 µF					6.0 (0.236)	12.0 (0.472)	10.4 (0.409)	7.5 (0.295)				
0.015 µF	4.0 (0.157)	9.0 (0.354)	13.0 (0.512)	10.0 (0.394)	5.0 (0.197)	11.0 (0.433)	13.0 (0.512)	10.0 (0.394)	5.5 (0.216)	10.5 (0.413)	18.0 (0.709)	15.0 (0.591)
0.022 µF					5.0 (0.197)	11.0 (0.433)	10.0 (0.394)	7.5 (0.295)				
0.022 µF	4.0 (0.157)	9.0 (0.354)	13.0 (0.512)	10.0 (0.394)	5.0 (0.197)	11.0 (0.433)	13.0 (0.512)	10.0 (0.394)	7.0 (0.276)	12.5 (0.492)	18.0 (0.709)	15.0 (0.591)
0.033 µF					6.0 (0.236)	11.0 (0.433)	13.0 (0.512)	10.0 (0.394)				
0.033 µF	4.0 (0.157)	9.0 (0.354)	13.0 (0.512)	10.0 (0.394)	5.5 (0.216)	10.5 (0.413)	18.0 (0.709)	15.0 (0.591)	7.0 (0.276)	15.0 (0.591)	25.5 (1.004)	22.5 (0.886)
0.047 µF					6.0 (0.236)	12.0 (0.472)	10.4 (0.409)	7.5 (0.295)				
0.047 µF	4.0 (0.157)	9.0 (0.354)	13.0 (0.512)	10.0 (0.394)	6.0 (0.236)	11.0 (0.433)	13.0 (0.512)	10.0 (0.394)				
0.047 µF	5.5 (0.216)	10.5 (0.413)	18.0 (0.709)	15.0 (0.591)	5.5 (0.216)	10.5 (0.413)	18.0 (0.709)	15.0 (0.591)	7.0 (0.276)	15.0 (0.591)	25.5 (1.004)	22.5 (0.886)
0.068 µF					6.0 (0.236)	12.0 (0.472)	10.4 (0.409)	7.5 (0.295)				
0.068 µF	6.0 (0.236)	12.0 (0.472)	10.4 (0.409)	7.5 (0.295)								
0.068 µF	5.0 (0.197)	11.0 (0.433)	13.0 (0.512)	10.0 (0.394)	7.0 (0.276)	14.0 (0.551)	13.0 (0.512)	10.0 (0.394)				
0.068 µF	5.5 (0.216)	10.5 (0.413)	18.0 (0.709)	15.0 (0.591)	5.5 (0.216)	10.5 (0.413)	18.0 (0.709)	15.0 (0.591)	7.0 (0.276)	15.0 (0.591)	25.5 (1.004)	22.5 (0.886)
0.1 µF												
0.1 µF	6.0 (0.236)	11.0 (0.433)	13.0 (0.512)	10.0 (0.394)	7.0 (0.276)	12.5 (0.492)	18.0 (0.709)	15.0 (0.591)				
0.1 µF	5.5 (0.216)	10.5 (0.413)	18.0 (0.709)	15.0 (0.591)	7.0 (0.276)	15.0 (0.591)	25.5 (1.004)	22.5 (0.886)	8.5 (0.335)	16.5 (0.650)	25.5 (1.004)	22.5 (0.886)
0.15 µF												
0.15 µF	7.0 (0.276)	14.0 (0.551)	13.0 (0.512)	10.0 (0.394)	9.0 (0.354)	14.5 (0.571)	18.0 (0.709)	15.0 (0.591)				
0.15 µF	5.5 (0.216)	10.5 (0.413)	18.0 (0.709)	15.0 (0.591)	7.0 (0.276)	15.0 (0.591)	25.5 (1.004)	22.5 (0.886)	11.0 (0.433)	20.0 (0.787)	32.0 (1.260)	27.5 (1.083)
0.22 µF												
0.22 µF	5.5 (0.216)	10.5 (0.413)	18.0 (0.709)	15.0 (0.591)	9.0 (0.354)	14.5 (0.571)	18.0 (0.709)	15.0 (0.591)				
0.22 µF	7.0 (0.276)	15.0 (0.591)	25.5 (1.004)	22.5 (0.886)	7.0 (0.276)	15.0 (0.591)	25.5 (1.004)	22.5 (0.886)	11.0 (0.433)	20.0 (0.787)	32.0 (1.260)	27.5 (1.083)
0.33 µF												
0.33 µF	7.0 (0.276)	12.5 (0.492)	18.0 (0.709)	15.0 (0.591)	10.5 (0.413)	19.5 (0.768)	25.5 (1.004)	22.5 (0.886)				
0.33 µF	7.0 (0.276)	15.0 (0.591)	25.5 (1.004)	22.5 (0.886)	11.0 (0.433)	20.0 (0.787)	32.0 (1.260)	27.5 (1.083)	14.0 (0.551)	25.0 (0.984)	32.0 (1.260)	27.5 (1.083)
0.47 µF												
0.47 µF	9.0 (0.354)	14.5 (0.571)	18.0 (0.709)	15.0 (0.591)								
0.47 µF	7.0 (0.276)	15.0 (0.591)	25.5 (1.004)	22.5 (0.886)	11.0 (0.433)	20.0 (0.787)	32.0 (1.260)	27.5 (1.083)	14.0 (0.551)	25.0 (0.984)	32.0 (1.260)	27.5 (1.083)
0.68 µF												
0.68 µF	7.0 (0.276)	15.0 (0.591)	25.5 (1.004)	22.5 (0.886)								
0.68 µF	11.0 (0.433)	20.0 (0.787)	32.0 (1.260)	27.5 (1.083)	14.0 (0.551)	25.0 (0.984)	32.0 (1.260)	27.5 (1.083)				
1 µF												
1 µF	7.0 (0.276)	15.0 (0.591)	25.5 (1.004)	22.5 (0.886)								
1 µF	11.0 (0.433)	20.0 (0.787)	32.0 (1.260)	27.5 (1.083)	14.0 (0.551)	25.0 (0.984)	32.0 (1.260)	27.5 (1.083)				
1.5 µF												
1.5 µF	10.5 (0.413)	19.5 (0.768)	25.5 (1.004)	22.5 (0.886)								
1.5 µF	11.0 (0.433)	20.0 (0.787)	32.0 (1.260)	27.5 (1.083)								
2.2 µF												
2.2 µF	14.0 (0.551)	25.0 (0.984)	32.0 (1.260)	27.5 (1.083)								

Packaging

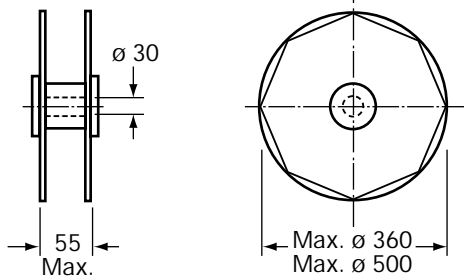
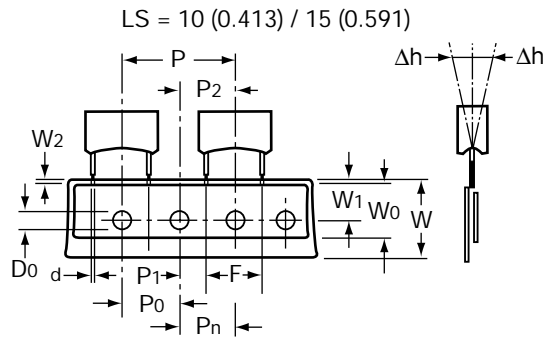
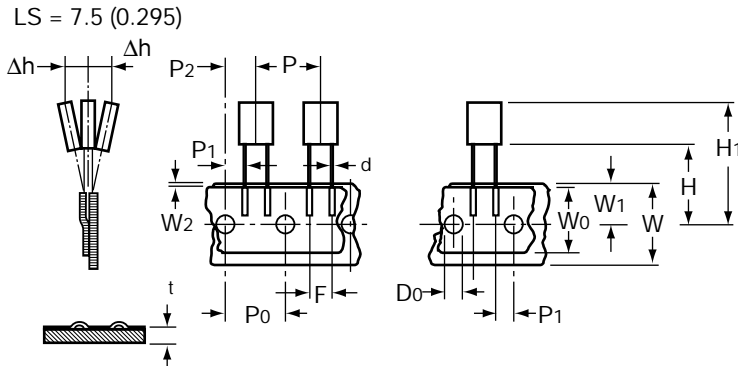

LS = 7.5 (0.295)
LS = 10 (0.394) or 15 (0.591)

LS	Dimensions	Primary Quantity	Minimum Qty. Order
7.5 (0.295)	2.5 x 7 x 10 (0.098 x 0.276 x 0.394)	2500	2500
	3 x 8 x 10 (0.118 x 0.315 x 0.394)	2500	2500
	4 x 9 x 10 (0.157 x 0.354 x 0.394)	2500	2500
	5 x 11 x 10 (0.197 x 0.433 x 0.394)	2000	2000
	6 x 12 x 10 (0.236 x 0.472 x 0.394)	1200	1200
10 (0.394)	4 x 9 x 13 (0.157 x 0.354 x 0.512)	2200	2200
	5 x 11 x 13 (0.197 x 0.433 x 0.512)	1500	1500
	6 x 11 x 13 (0.236 x 0.433 x 0.512)	1200	1200
15 (0.591)	7 x 14 x 13 (0.276 x 0.551 x 0.512)	800	800
	5.5 x 10.5 x 18 (0.216 x 0.413 x 0.709)	1700	1700
22.5 (0.886)	9 x 14.5 x 18 (0.354 x 0.571 x 0.709)	1200	1200
	7 x 12.5 x 18 (0.276 x 0.492 x 0.709)	800	800
	7 x 15 x 25.5 (0.276 x 0.591 x 1.004)	700	700
27.5 (1.083)	8.5 x 16.5 x 25.5 (0.335 x 0.650 x 1.004)	500	500
	10 x 19.5 x 25.5 (0.394 x 0.768 x 1.004)	350	350
27.5 (1.083)	11 x 20 x 32 (0.433 x 0.787 x 1.260)	300	6000
	14 x 25 x 32 (0.551 x 0.984 x 1.260)	200	6000

millimeters (inches)

LS	e	Quantity per reel
7.5 (0.295)	e = 2.5 (0.098)	2500
	e = 3 (0.118)	2000
	e = 4 (0.157)	1500
	e = 5 (0.197)	1200
	e = 6 (0.236)	1000
10 (0.394)	e = 4 (0.157)	1500
	e = 5 (0.197)	1300
	e = 6 (0.236)	1000
15 (0.591)	e = 7 (0.276)	900
	e = 5.5 (0.216)	1100
	e = 7 (0.276)	900
15 (0.591)	e = 9 (0.354)	600

Symbol	Dimensions			Tol	Note
	P=7.5 (0.295)	P=10 (0.394)	P=15 (0.591)		
d	0.6 (0.024)	0.6 (0.024)	0.8 (0.031)	±0.05	
P ₁	2.6 (0.103)	7.7 (0.303)	5.2 (0.205)	±0.7	
P ₂	6.35 (0.250)	12.7 (0.500)	12.7 (0.500)	±1	
F	7.5 (0.295)	10 (0.000)	15 (0.000)	±0.6 -0.1	
P	12.7 (0.500)	25.4 (1.000)	25.4 (1.000)	±1	
P ₀	12.7 (0.500)	12.7 (0.500)	12.7 (0.500)	±0.2	
Ah	0 (0.000)	0 (0.000)	0 (0.000)	±0.2	
W	18 (0.709)	18 (0.709)	18 (0.709)	±0.5	
W ₀	15 (0.591)	15 (0.591)	15 (0.591)		Max.
W ₁	9 (0.354)	9 (0.354)	9 (0.354)	±0.5	
W ₂	0.5 [±] (0.020)	0.5 [±] (0.020)	0.5 [±] (0.020)		
H	16.5 (0.650)	16.0 (0.630)	16.0 (0.630)	±0.3	
	18.5 (0.728)	18.5 (0.728)	18.5 (0.728)	±0.5	
H ₁	32 (1.260)	32 (1.260)	32 (1.260)		Max.
D ₀	4 (0.157)	4 (0.157)	4 (0.157)	±0.2	

BC/BD 15



15 Radial Leads — 250 V-

APPLICATIONS

Non-inductive, self-healing, metallized polyester film capacitor. Insulated* thermoplastic casing, epoxy resin sealed with stand-offs*. Radial connections.

* Flame retardant resin and case according to UL 94 VO.

Some examples of use:

Telecom applications, linking function in the ringing circuit.

STANDARDIZATION

Generic specifications:

CEI 384-1/CECC 30000/UTE 83100

Sectional specifications:

CEI 384-2/CECC 30400/UTE 83151

Schematic Cross Section

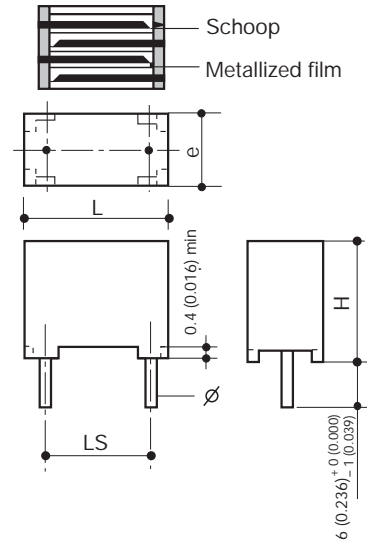

DIMENSIONS:

millimeters (inches)

Type	Case	C_R (μF)	L max	h max	e max	LS ± 0.4	\varnothing $+10\% -0.05$
BC 15	i0	0.47	17.5 (0.689)	12.0 (0.472)	6.0 (0.236)	15.0 (0.591)	0.8 (0.031)
	8	0.68	17.5 (0.689)	13.5 (0.531)	6.25 (0.246)	15.0 (0.591)	0.8 (0.031)
	9	0.80	17.5 (0.689)	14.5 (0.571)	8.5 (0.335)	15.0 (0.591)	0.8 (0.031)
	9	0.82	17.5 (0.689)	14.5 (0.571)	8.5 (0.335)	15.0 (0.591)	0.8 (0.031)
	9	1.0	17.5 (0.689)	14.5 (0.571)	8.5 (0.335)	15.0 (0.591)	0.8 (0.031)
	9	1.5	17.5 (0.689)	14.5 (0.571)	8.5 (0.335)	15.0 (0.591)	0.8 (0.031)
	9	2.2	17.5 (0.689)	14.5 (0.571)	8.5 (0.335)	15.0 (0.591)	0.8 (0.031)
BD 15	8	0.80	17.5 (0.689)	13.5 (0.531)	6.25 (0.246)	15.0 (0.591)	0.8 (0.031)
	8	0.82	17.5 (0.689)	13.5 (0.531)	6.25 (0.246)	15.0 (0.591)	0.8 (0.031)
	8	1.0	17.5 (0.689)	13.5 (0.531)	6.25 (0.246)	15.0 (0.591)	0.8 (0.031)

HOW TO ORDER

BC 15



Type

4



Class

G



Voltage

0105



Capacitance Value

K



Tolerance

--



Suffix
Tape and Reel
See page 27

PERFORMANCE CHARACTERISTICS

Climatic category:	55/100/56
Capacitance (C_R):	See table
Tolerance:	$\pm 5\%$, $\pm 10\%$
Nominal voltage (V_R):	250 V ₋
Test voltage ($1.4 V_R$):	350 V ₋
Category voltage (V_C at 100°C):	$0.75 V_R$
Tangent of loss angle at 1 kHz (D.F.):	$\leq 80 \cdot 10^{-4}$
Insulation resistance between terminals (IR under 100 V-):	$I_R \cdot C_R \geq 10 \text{ G}\Omega \mu\text{F}$
Insulation resistance between terminals and case:	$\geq 30 \text{ G}\Omega$
Voltage gradient (max. dv/dt peak):	30 V/ μs

MARKING

BC 1 μ0 K
250 V-

Logo
Nominal capacitance
Tolerance (EIA code)
DC nominal voltage

CHARACTERISTIC CURVES

Nominal RMS voltage vs. frequency (room temperature) allowing a 10°C increase of the external temperature of the box.

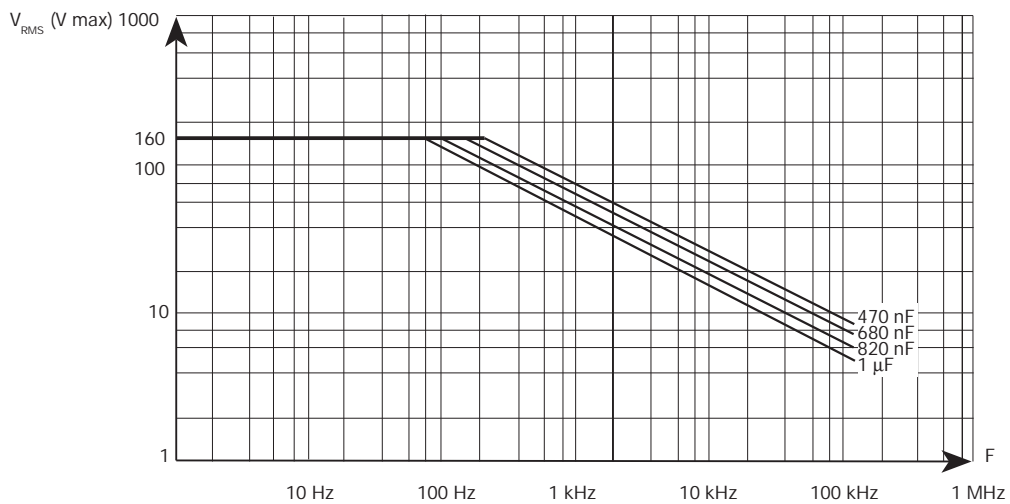

BO 07/10/15/27

CPM-50 — 7.5/10/15/27.5 Radial Leads

40/63/160/250/400 V-



APPLICATIONS

Non-inductive, capacitor for professional use with radial leads. Insulated thermoplastic casing, epoxy resin sealed with stand-offs.

Some examples of use:

Oscillating circuit, LF filter, coupling and decoupling, frequency discriminator.

STANDARDIZATION

Generic specifications:

CEI 384-1/CECC 30000/UTE 83100

Sectional specifications:

CEI 384-2/CECC 30400/UTE 83151

On the LNZ 44-04 list:

Complies with type CPM50

On the GAM-T1 list:

ARIANE qualified

Schematic Cross Section

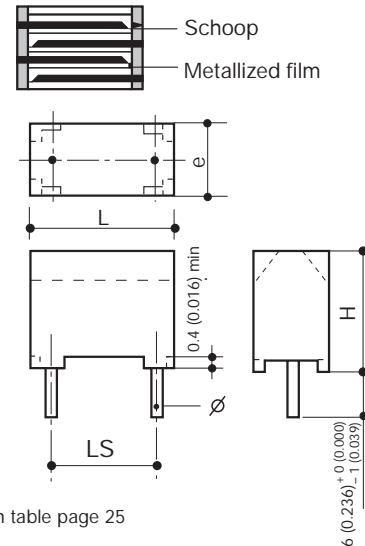

DIMENSIONS:

millimeters (inches)

Size Code	L max.	H max.	e max.	LS ±0.4	Ø ^{+10%} _{-0.05}	Observations
07	10.1 (0.398)	10.0 (0.394)	5.0 (0.197)	7.5 (0.295)	0.6 (0.024)	1nF ≤ C _R ≤ 8.2nF
10	12.5 (0.492)	10.0 (0.394)	5.0 (0.197)	10.0 (0.394)	0.6 (0.024)	4.7nF ≤ C _R ≤ 220nF
15	17.5 (0.689)	10.5 ... 16.5 (0.413 ... 0.650)	5.0 ... 10.0 (0.197 ... 0.394)	15.0 (0.591)	0.8 (0.031)	15nF ≤ C _R ≤ 2.2µF
27	31.25 (1.230)	15.0 ... 30.0 (0.591 ... 1.181)	7.5 ... 17.5 (0.295 ... 0.689)	27.5 (1.083)	0.8 (0.031)	150nF ≤ C _R ≤ 22µF

HOW TO ORDER

BO 15



Type

4



Class

G



Voltage

0104



Capacitance Value

K



Tolerance

--



Suffix
Tape and Reel
See page 27

PERFORMANCE CHARACTERISTICS

Climatic category: 55/125/56 - Performance Class 1

Capacitance range: C_R 1 nF to 2.2 µF

Tolerances on C_R: ±5%, ±10%, ±20% (E6)
(assoc. series) (other values on request)

Nominal voltages: V_{R-} 40/63/160/250/400 V
V_{R-} 25/40/100/180/200 V

Category voltage: V_C = 0.5 V_{R-} at 125°C

Test voltage: V_e = 1.6 V_{R-}

Tangent of loss angle: D.F. (see page 4)

Insulation resistance: IR (see page 5)

MARKING

Logo - CPM50B

Capacitance and tolerance
(CEI 62 code)

Nominal voltage

Date of manufacture

2 letter code

(year - month) according
to CEI 62

NOMINAL VOLTAGE (V_R) AND CAPACITANCE VALUES (C_R) DEPENDING ON THE DIMENSIONS

S i z e	C a s e	DIMENSIONS: millimeters (inches)					Reference				
							BO				
		Max L	Max H	Max e	\varnothing ^{+10%} _{-0.05}	LS ± 0.4	V_{R-}/V_{R-}				
							40/25	63/40	160/100	250/180	400/200
							Range of Capacitance (C_R min. ... max.)				
07	2	10.1 (0.398)	10.0 (0.394)	5.0 (0.197)	0.6 (0.024)	7.5 (0.295)	-	-	-	4.7 nF/8.2 nF	1 nF ... 3.3 nF
10	4	12.5 (0.492)	10.0 (0.394)	5.0 (0.197)	0.6 (0.024)	10.0 (0.394)	68 nF ... 220 nF	33 nF ... 100 nF	10 nF ... 47 nF	10 nF ... 22 nF	4.7 nF ... 10 nF
15	6	17.5 (0.689)	10.5 (0.413)	5.0 (0.197)	0.8 (0.031)	15.0 (0.591)	330 nF/470 nF	150 nF/220 nF	68 nF ... 150 nF	33 nF/47 nF	15 nF/22 nF
	7	17.5 (0.689)	13.5 (0.531)	5.0 (0.197)	0.8 (0.031)		680 nF	330 nF	220 nF	68 nF	33 nF
	8	17.5 (0.689)	13.5 (0.531)	6.25 (0.246)	0.8 (0.031)		1 μ F	470 nF	-	100 nF	47 nF
	9	17.5 (0.689)	14.5 (0.571)	8.5 (0.335)	0.8 (0.031)		1.5 μ F	680 nF	330 nF	150 nF	68 nF
	10	17.5 (0.689)	16.5 (0.650)	10.0 (0.394)	0.8 (0.031)		2.2 μ F	1 μ F	470 nF	220 nF	100 nF
27	14	31.25 (1.230)	15.0 (0.591)	7.5 (0.295)	0.8 (0.031)	27.5 (1.083)	3.3 μ F	1.5 μ F	680 nF/1 μ F	330 nF	330 nF
	15	31.25 (1.230)	17.5 (0.689)	8.75 (0.344)	0.8 (0.031)		4.7 μ F	2.2 μ F	1.5 μ F/2.2 μ F	470 nF	220 nF
	16	31.25 (1.230)	19.5 (0.768)	10.0 (0.394)	0.8 (0.031)		6.8 μ F	3.3 μ F	-	680 nF	330 nF
	17*	31.25 (1.230)	22.5 (0.886)	12.5 (0.492)	0.8 (0.031)		10 μ F	4.7 μ F	-	1 μ F	470 nF
	18*	31.25 (1.230)	26.0 (1.024)	15.0 (0.591)	0.8 (0.031)		15 μ F	6.8 μ F	3.3 μ F	1.5 μ F	680 nF
	19*	31.25 (1.230)	30.0 (1.181)	17.5 (0.689)	0.8 (0.031)		22 μ F	10 μ F	4.7 μ F/6.8 μ F	2.2 μ F	1 μ F

CHARACTERISTIC CURVES

Influence of the frequency on the impedance (room temperature).

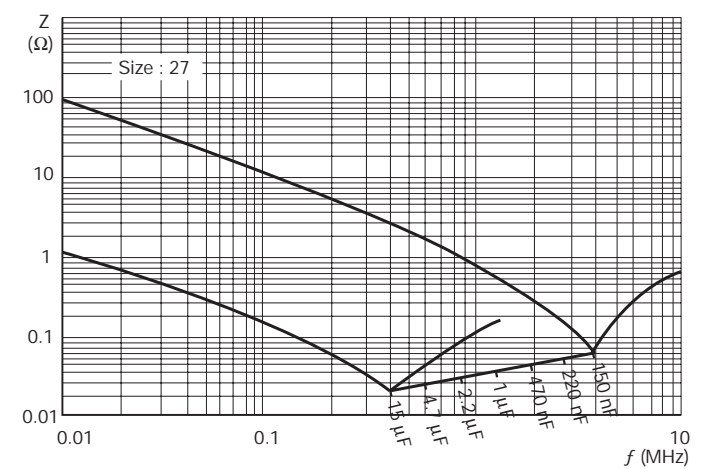
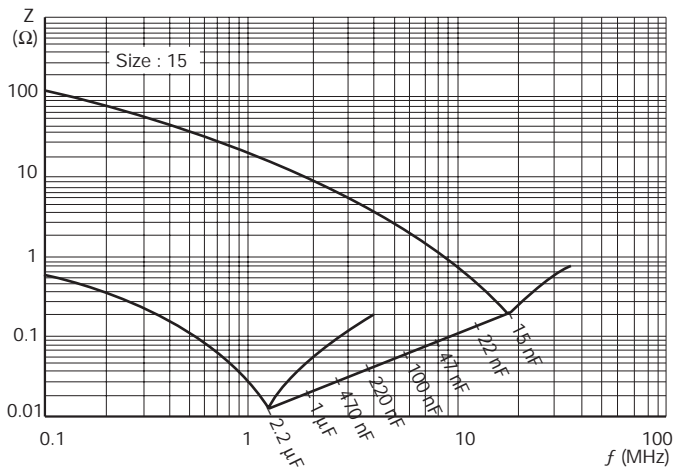
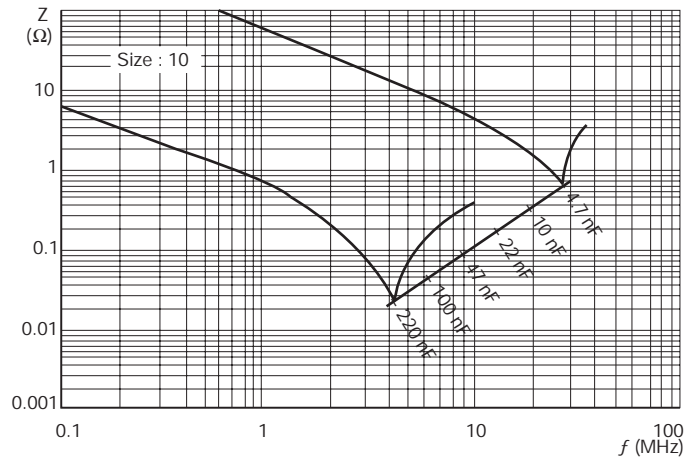
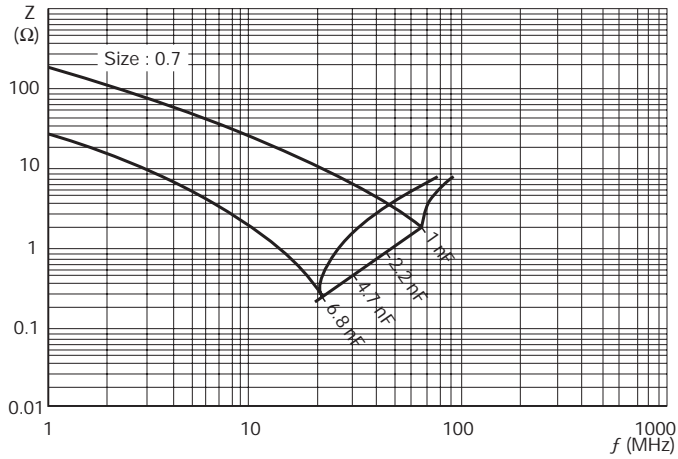

CHARACTERISTICS OF THE REEL –

Suffixes to be used (see page 7) millimeters (inches)

	Taping Suffix EN		
	Lead Spacing tol ± 0.4 (0.016)		
	7.5 (0.295)	10 (0.394)	15 (0.590)
P	12.7 ± 1.0 (0.5 ± 0.039)	25.4 ± 1.0 (1.0 ± 0.039)	
H	16.5 ± 0.3 (0.650 ± 0.012)		$16^{+1.5}_{-0.5}$ ($0.630^{+0.058}_{-0.020}$)

PACKAGING

Size	Case Code	Minimum Quantity*	
		Reel	Bulk
7.5	1	2000	3000
	2	1250	1750
	C	1250	1500
	D	1000	1000
10	E0	850	1750
	4	700	1250
	5	700	1000
15	6	1000	750
	7	1000	3000
	10	1000	750
	8	833	3000
	9	625	2000
22	11	-	200
	12	-	200
	13	-	150
27	14	-	160
	15	-	140
	16	-	120
	17	-	100
	18	-	80
	19	-	65

* Ordering quantities must be a multiple of the above figures

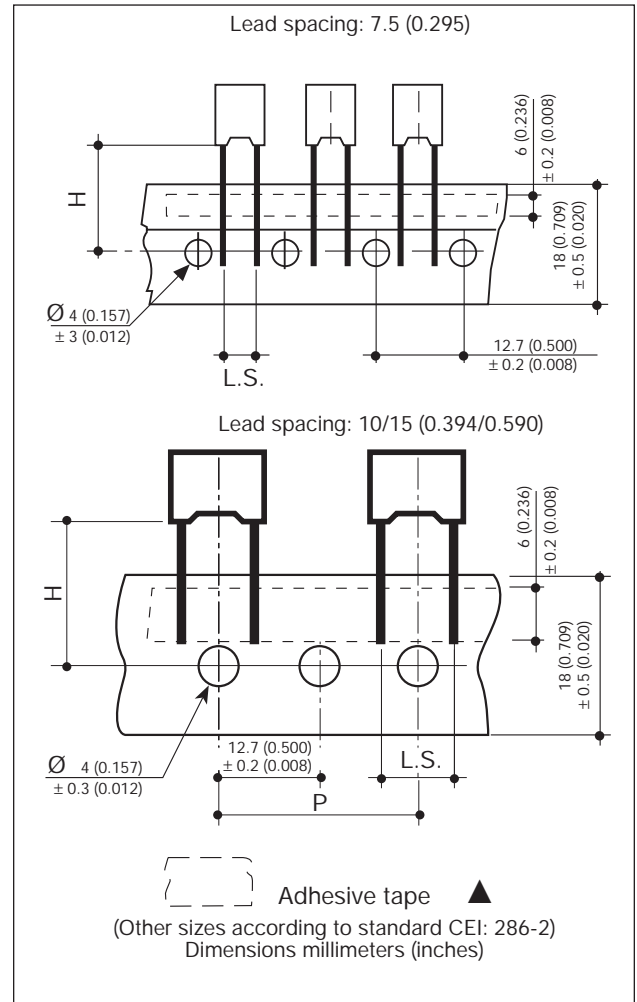

Lead Spacing	D	E (ext)
7.5/10	360 (14.173)	48 (1.890)
15	500 (19.685)	52 (2.047)

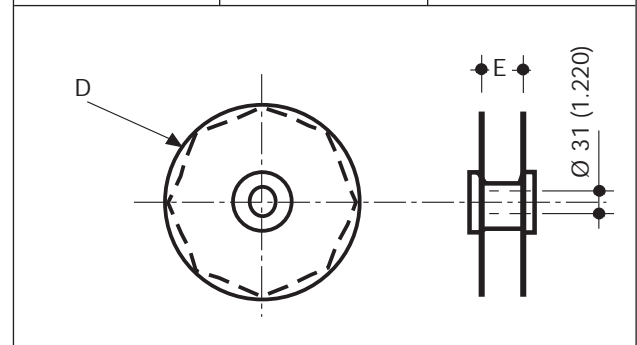

APPLICATIONS

Non-inductive, capacitor for professional use with radial leads. Flat, insulated (polyester tape wrapping) epoxy resin sealed.

Some examples of use:

Oscillating circuit, LF filter, coupling and decoupling, frequency discriminator.

STANDARDIZATION

Generic specifications:

CEI 384-1/CECC 30000/UTE 83100

Sectional specifications:

CEI 384-2/CECC 30400/UTE 83151

On the LNZ 44-04 list:

Complies with type CPM13

On the GAM-T1 list.

Schematic Cross Section

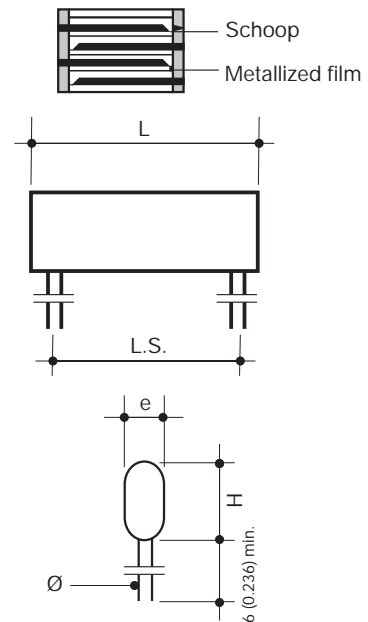

DIMENSIONS:

millimeters (inches)

Size Code	L max.	H max.	e max.	LS ±0.5	$\varnothing^{+10\%}_{-0.05}$	Observations
07	12.0 (0.472)	7.5 (0.295)	4.5 (0.177)	7.62 (0.300)	0.6 (0.024)	$1\text{nF} \leq C_R \leq 6.8\text{nF}$
10	14.5 (0.571)	7.5 / 8.0 (0.295 / 0.315)	4.5 / 5.0 (0.177 / 0.197)	10.16 (0.400)	0.6 (0.024)	$4.7\text{nF} \leq C_R \leq 100\text{nF}$
15	20.0 (0.787)	8.0 ... 15.5 (0.315 ... 0.610)	4.5 ... 10.5 (0.177 ... 0.413)	15.24 (0.600)	0.8 (0.031)	$15\text{nF} \leq C_R \leq 1\mu\text{F}$
27	33.0 (1.299)	11.0 ... 27.5 (0.433 ... 1.083)	8.0 ... 18.0 (0.315 ... 0.709)	27.94 (1.100)	1.0 (0.039)	$150\text{nF} \leq C_R \leq 10\mu\text{F}$

HOW TO ORDER

S4 15



Type

4



Class

G



Voltage

0104



Capacitance Value

K



Tolerance

--



Suffix
Tape and Reel
See page 47

PERFORMANCE CHARACTERISTICS

Climatic category: 55/125/21 - Performance Class 1

Capacitance range: C_R 1 nF to 10 μF

Tolerances on C_R : $\pm 5\%$, $\pm 10\%$, $\pm 20\%$ (E6)
(assoc. series) (other values on request)

Nominal voltages: V_{R-} 63/160/250/400 V
 V_{R-} 40/100/160/200 V

Category voltage: $V_C = 0.5 V_{R-}$ at 125°C

Test voltage: $V_e = 1.6 V_{R-}$

Tangent of loss angle: D.F. (see page 4)

Insulation resistance: IR (see page 5)

MARKING

Logo - CPM13B

Capacitance and tolerance
(CEI 62 code)

Nominal voltage

Date of manufacture

2 letter code

(year - month) according
to CEI 62

except for L = 12 and 14.5mm

NOMINAL VOLTAGE (V_R) AND CAPACITANCE VALUES (C_R) DEPENDING ON THE DIMENSIONS

Size Code	DIMENSIONS: millimeters (inches)					Reference			
						S4			
	Max L	Max H	Max e	\varnothing ^{+10%} _{-0.05}	LS ± 0.5	V_{R-}/V_{R-}			
						63/40	160/100	250/160	400/200
						Range of Capacitance (C_R min. ... max.)			
07	12.0 (0.472)	7.5 (0.295)	4.5 (0.177)	0.6 (0.024)	7.62 (0.300)	-	-	4.7 nF/6.8 nF	1 nF ... 3.3 nF
10	14.5 (0.571)	7.5 (0.295)	4.5 (0.177)	0.6 (0.024)	10.16 (0.400)	33 nF ... 100 nF	10 nF ... 33 nF	10 nF ... 22 nF	4.7 nF ... 10 nF
	14.5 (0.571)	8.0 (0.315)	5.0 (0.197)	0.6 (0.024)		-	47 nF	-	-
15	20.0 (0.787)	8.0 (0.315)	4.5 (0.177)	0.8 (0.031)	15.24 (0.600)	-	68 nF	33 nF	15 nF
	20.0 (0.787)	8.0 (0.315)	5.5 (0.217)	0.8 (0.031)		-	100 nF	-	-
	20.0 (0.787)	8.5 (0.335)	4.5 (0.177)	0.8 (0.031)		150 nF	-	-	-
	20.0 (0.787)	8.5 (0.335)	5.0 (0.197)	0.8 (0.031)		220nF	-	-	22 nF
	20.0 (0.787)	9.0 (0.354)	5.0 (0.197)	0.8 (0.031)		-	-	47 nF	-
	20.0 (0.787)	9.0 (0.354)	6.0 (0.236)	0.8 (0.031)		330 nF	-	68 nF	-
	20.0 (0.787)	9.5 (0.374)	6.0 (0.236)	0.8 (0.031)		-	-	-	33 nF
	20.0 (0.787)	9.5 (0.374)	6.5 (0.256)	0.8 (0.031)		-	150 nF	-	-
	20.0 (0.787)	10.0 (0.394)	7.0 (0.276)	0.8 (0.031)		470 nF	-	100 nF	-
	20.0 (0.787)	10.5 (0.413)	6.5 (0.256)	0.8 (0.031)		-	-	-	47 nF
	20.0 (0.787)	10.5 (0.413)	7.5 (0.295)	0.8 (0.031)		-	220 nF	-	-
	20.0 (0.787)	11.5 (0.453)	8.5 (0.335)	0.8 (0.031)		680 nF	-	-	-
	20.0 (0.787)	13.5 (0.531)	6.5 (0.256)	0.8 (0.031)		-	-	-	68 nF
	20.0 (0.787)	13.5 (0.531)	8.0 (0.315)	0.8 (0.031)		-	-	150 nF	-
	20.0 (0.787)	13.5 (0.531)	10.5 (0.413)	0.8 (0.031)		1 μ F	-	-	-
	20.0 (0.787)	14.0 (0.551)	7.5 (0.295)	0.8 (0.031)		-	330 nF	-	-
	20.0 (0.787)	15.0 (0.591)	8.5 (0.335)	0.8 (0.031)		-	-	220 nF	100 nF
	20.0 (0.787)	15.5 (0.610)	9.0 (0.354)	0.8 (0.031)		-	470 nF	-	-
27	33.0 (1.299)	11.0 (0.433)	8.0 (0.315)	1.0 (0.039)	27.94 (1.100)	1.5 μ F	-	-	-
	33.0 (1.299)	13.0 (0.512)	7.0 (0.276)	1.0 (0.039)		-	-	-	150 nF
	33.0 (1.299)	13.0 (0.512)	10.0 (0.394)	1.0 (0.039)		2.2 μ F	-	-	-
	33.0 (1.299)	13.5 (0.531)	7.5 (0.295)	1.0 (0.039)		-	680 nF	330 nF	-
	33.0 (1.299)	14.5 (0.571)	8.5 (0.335)	1.0 (0.039)		-	-	470 nF	220 nF
	33.0 (1.299)	14.5 (0.571)	11.5 (0.453)	1.0 (0.039)		3.3 μ F	-	-	-
	33.0 (1.299)	15.0 (0.591)	9.0 (0.354)	1.0 (0.039)		-	1 μ F	-	-
	33.0 (1.299)	15.0 (0.591)	10.5 (0.413)	1.0 (0.039)		-	-	-	330 nF
	33.0 (1.299)	15.5 (0.610)	11.0 (0.433)	1.0 (0.039)		-	-	680 nF	-
	33.0 (1.299)	16.0 (0.630)	11.5 (0.453)	1.0 (0.039)		-	1.5 μ F	-	-
	33.0 (1.299)	18.5 (0.728)	14.0 (0.551)	1.0 (0.039)		4.7 μ F	-	-	-
	33.0 (1.299)	20.0 (0.787)	12.0 (0.472)	1.0 (0.039)		-	2.2 μ F	-	-
	33.0 (1.299)	20.5 (0.807)	11.0 (0.433)	1.0 (0.039)		-	-	1 μ F	470 nF
	33.0 (1.299)	21.0 (0.827)	16.5 (0.650)	1.0 (0.039)		6.8 μ F	-	-	-
	33.0 (1.299)	23.5 (0.925)	14.0 (0.551)	1.0 (0.039)		-	-	-	680 nF
	33.0 (1.299)	24.0 (0.945)	14.5 (0.571)	1.0 (0.039)		-	-	1.5 μ F	-
	33.0 (1.299)	24.5 (0.965)	15.0 (0.591)	1.0 (0.039)		-	3.3 μ F	-	-
	33.0 (1.299)	26.5 (1.043)	17.0 (0.669)	1.0 (0.039)		-	-	-	1 μ F
33.0 (1.299)	27.5 (1.083)	18.0 (0.709)	1.0 (0.039)	10 μ F	4.7 μ F	2.2 μ F	-		

CHARACTERISTIC CURVES

Influence of the frequency on the impedance (room temperature).

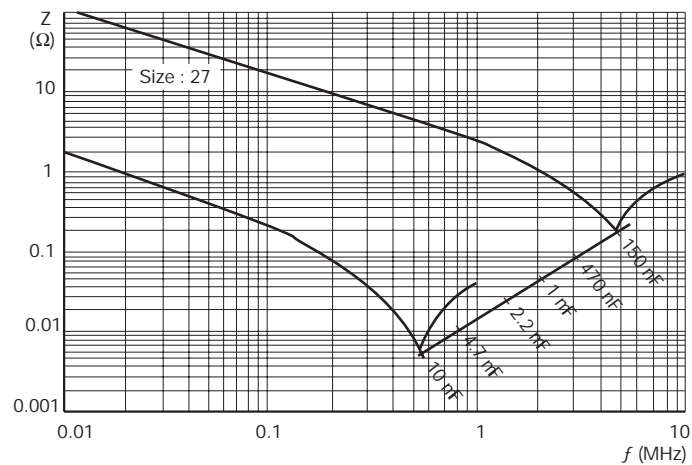
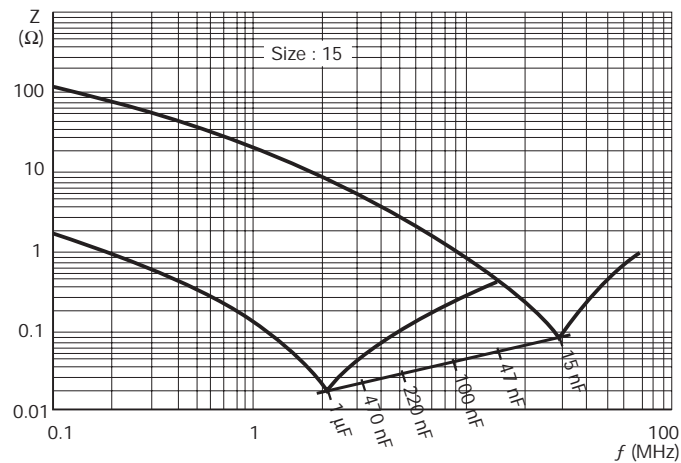
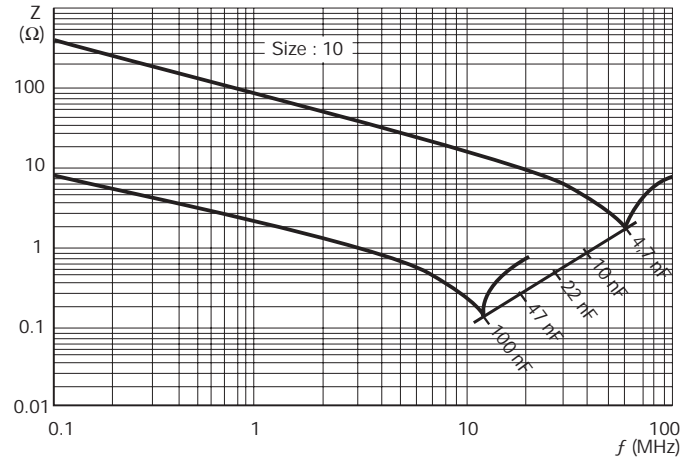

APPLICATIONS

Non-inductive, capacitor for professional use. Flat axial, polyester wrapped, epoxy resin sealed.

Some examples of use:

Oscillating circuit, LF filter, coupling and decoupling, frequency discriminator.

STANDARDIZATION

Generic specifications:

CEI 384-1/CECC 30000/UTE 83100

Sectional specifications:

CEI 384-2/CECC 30400/UTE 83151

On the LNZ 44-04 list:

Complies with type CPM8

NOTE: For new design, please refer to SH series (optimized range)

Schematic Cross Section

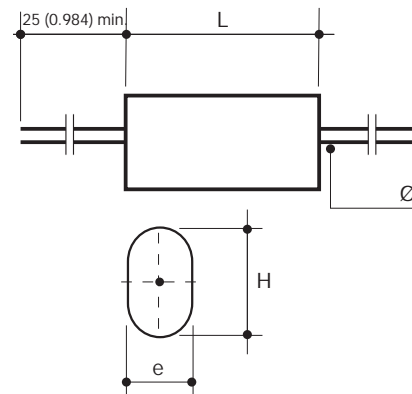

DIMENSIONS:

millimeters (inches)

Size Code	L max.	H max.	e max.	$\varnothing^{+10\%}_{-0.05}$	Observations
10	12.0 (0.472)	6.5 (0.256)	4.0 (0.157)	0.6 (0.024)	$1\text{nF} \leq C_R \leq 6.8\text{nF}$
14	14.5 (0.571)	6.0 ... 8.0 (0.236...0.315)	3.5 / 5.0 (0.138 / 0.197)	0.6 (0.024)	$4.7\text{nF} \leq C_R \leq 100\text{nF}$
18	20.0 (0.787)	8.0 ... 15.5 (0.315...0.610)	4.5 ... 10.5 (0.177...0.413)	0.8 (0.031)	$15\text{nF} \leq C_R \leq 1\mu\text{F}$
31	33.0 (1.299)	11.0... 27.5 (0.433...1.083)	7.0 ... 18.0 (0.276...0.709)	1.0 (0.039)	$150\text{nF} \leq C_R \leq 10\mu\text{F}$

HOW TO ORDER

S8 15



Type

4



Class

G



Voltage

0104



Capacitance Value

K



Tolerance

--



Suffix
Tape and Reel
See page 47

PERFORMANCE CHARACTERISTICS

Climatic category: 55/125/21 - Performance Class 1

Capacitance range: C_R 1 nF to 10 μF

Tolerances on C_R (assoc. series): $\pm 5\%$, $\pm 10\%$, $\pm 20\%$ (E6)
(other values on request)

Nominal voltages: V_{R-} 63/160/250/400 V
 V_{R-} 40/100/160/200 V

Category voltage: $V_C = 0.5 V_{R-}$ at 125°C

Test voltage: $V_e = 1.6 V_{R-}$

Tangent of loss angle: D.F. (see page 4)

Insulation resistance: IR (see page 5)

MARKING

Logo - CPM8B

Capacitance and tolerance
(CEI 62 code)

Nominal voltage

Date of manufacture

2 letter code

(year - month) according
to CEI 62

except for L = 12 and 14.5mm

NOMINAL VOLTAGE (V_R) AND CAPACITANCE VALUES (C_R) DEPENDING ON THE DIMENSIONS

Size Code	DIMENSIONS: millimeters (inches)				Reference			
					S8			
	Max L	Max H	Max e	\varnothing ^{+10%} _{-0.05}	V_R/V_{R-}			
					63/40	160/100	250/160	400/200
					Range of Capacitance (C_R min. ... max.)			
10	12.0 (0.472)	6.5 (0.256)	4.0 (0.157)	0.6 (0.024)	-	-	4.7 nF/6.8 nF	1 nF ... 3.3 nF
14	14.5 (0.571)	6.0 (0.236)	3.5 (0.138)	0.6 (0.024)	33 nF	-	-	-
	14.5 (0.571)	6.5 (0.256)	3.5 (0.138)	0.6 (0.024)	47 nF	-	-	-
	14.5 (0.571)	6.5 (0.256)	4.0 (0.157)	0.6 (0.024)	-	10 nF/22 nF	10 nF	4.7 nF
	14.5 (0.571)	7.0 (0.276)	4.0 (0.157)	0.6 (0.024)	68 nF	-	15 nF	-
	14.5 (0.571)	7.0 (0.276)	4.5 (0.177)	0.6 (0.024)	-	-	-	6.8 nF/10 nF
	14.5 (0.571)	7.5 (0.295)	4.5 (0.177)	0.6 (0.024)	100 nF	33 nF	22 nF	-
	14.5 (0.571)	8.0 (0.315)	5.0 (0.197)	0.6 (0.024)	-	47 nF	-	-
18	20.0 (0.787)	8.0 (0.315)	4.5 (0.177)	0.8 (0.031)	-	68 nF	33 nF	15 nF
	20.0 (0.787)	8.0 (0.315)	5.5 (0.217)	0.8 (0.031)	-	100 nF	-	-
	20.0 (0.787)	8.5 (0.335)	4.5 (0.177)	0.8 (0.031)	150 nF	-	-	-
	20.0 (0.787)	8.5 (0.335)	5.0 (0.197)	0.8 (0.031)	220 nF	-	-	22 nF
	20.0 (0.787)	9.0 (0.354)	5.0 (0.197)	0.8 (0.031)	-	-	47 nF	-
	20.0 (0.787)	9.0 (0.354)	6.0 (0.236)	0.8 (0.031)	330 nF	-	68 nF	-
	20.0 (0.787)	9.5 (0.374)	6.0 (0.236)	0.8 (0.031)	-	-	-	33 nF
	20.0 (0.787)	9.5 (0.374)	6.5 (0.256)	0.8 (0.031)	-	150 nF	-	-
	20.0 (0.787)	10.0 (0.394)	7.0 (0.276)	0.8 (0.031)	470 nF	-	100 nF	-
	20.0 (0.787)	10.5 (0.413)	6.5 (0.256)	0.8 (0.031)	-	-	-	47 nF
	20.0 (0.787)	10.5 (0.413)	7.5 (0.295)	0.8 (0.031)	-	220 nF	-	-
	20.0 (0.787)	11.5 (0.453)	8.5 (0.335)	0.8 (0.031)	680 nF	-	-	-
	20.0 (0.787)	13.5 (0.531)	6.5 (0.256)	0.8 (0.031)	-	-	-	68 nF
	20.0 (0.787)	13.5 (0.531)	8.0 (0.315)	0.8 (0.031)	-	-	150 nF	-
	20.0 (0.787)	13.5 (0.531)	10.5 (0.413)	0.8 (0.031)	1 μ F	-	-	-
	20.0 (0.787)	14.0 (0.551)	7.5 (0.295)	0.8 (0.031)	-	330 nF	-	-
	20.0 (0.787)	15.0 (0.591)	8.5 (0.335)	0.8 (0.031)	-	-	220 nF	100 nF
20.0 (0.787)	15.5 (0.610)	9.0 (0.354)	0.8 (0.031)	-	470 nF	-	-	
31	33.0 (1.299)	11.0 (0.433)	8.0 (0.315)	1.0 (0.039)	1.5 μ F	-	-	-
	33.0 (1.299)	13.0 (0.512)	7.0 (0.276)	1.0 (0.039)	-	-	-	150 nF
	33.0 (1.299)	13.0 (0.512)	10.0 (0.394)	1.0 (0.039)	2.2 μ F	-	-	-
	33.0 (1.299)	13.5 (0.531)	7.5 (0.295)	1.0 (0.039)	-	680 nF	330 nF	-
	33.0 (1.299)	14.5 (0.571)	8.5 (0.335)	1.0 (0.039)	-	-	470 nF	220 nF
	33.0 (1.299)	14.5 (0.571)	11.5 (0.453)	1.0 (0.039)	3.3 μ F	-	-	-
	33.0 (1.299)	15.0 (0.591)	9.0 (0.354)	1.0 (0.039)	-	1 μ F	-	-
	33.0 (1.299)	15.0 (0.591)	10.5 (0.413)	1.0 (0.039)	-	-	-	330 nF
	33.0 (1.299)	15.5 (0.610)	11.0 (0.433)	1.0 (0.039)	-	-	680 nF	-
	33.0 (1.299)	16.0 (0.630)	11.5 (0.453)	1.0 (0.039)	-	1.5 μ F	-	-
	33.0 (1.299)	18.5 (0.728)	14.0 (0.551)	1.0 (0.039)	4.7 μ F	-	-	-
	33.0 (1.299)	20.0 (0.787)	12.0 (0.472)	1.0 (0.039)	-	2.2 μ F	-	-
	33.0 (1.299)	20.5 (0.807)	11.0 (0.433)	1.0 (0.039)	-	-	1 μ F	470 nF
	33.0 (1.299)	21.0 (0.827)	16.5 (0.650)	1.0 (0.039)	6.8 μ F	-	-	-
	33.0 (1.299)	23.5 (0.925)	14.0 (0.551)	1.0 (0.039)	-	-	-	680 nF
	33.0 (1.299)	24.0 (0.945)	14.5 (0.571)	1.0 (0.039)	-	-	1.5 μ F	-
	33.0 (1.299)	24.5 (0.965)	15.0 (0.591)	1.0 (0.039)	-	3.3 μ F	-	-
	33.0 (1.299)	26.5 (1.043)	17.0 (0.669)	1.0 (0.039)	-	-	-	1 μ F
	33.0 (1.299)	27.5 (1.083)	18.0 (0.709)	1.0 (0.039)	10 μ F	4.7 μ F	2.2 μ F	-

CHARACTERISTIC CURVES

Influence of the frequency on the impedance (room temperature).

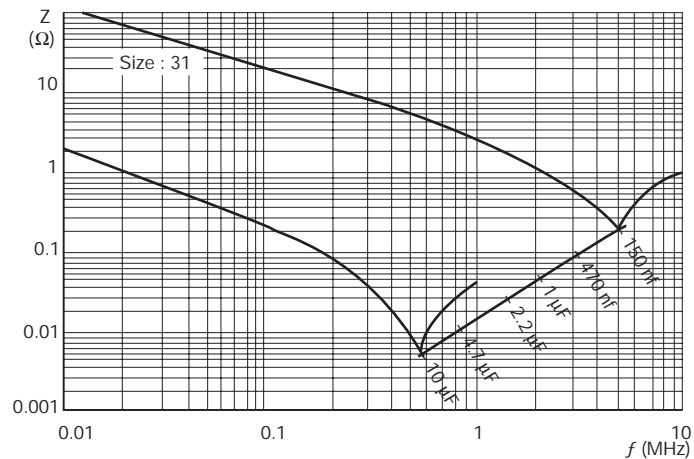
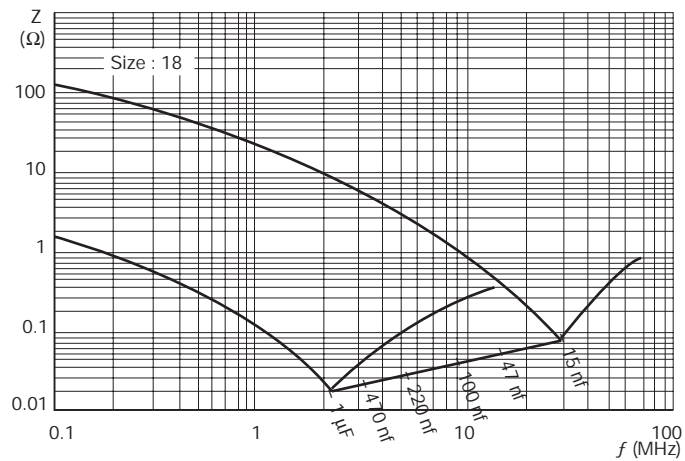
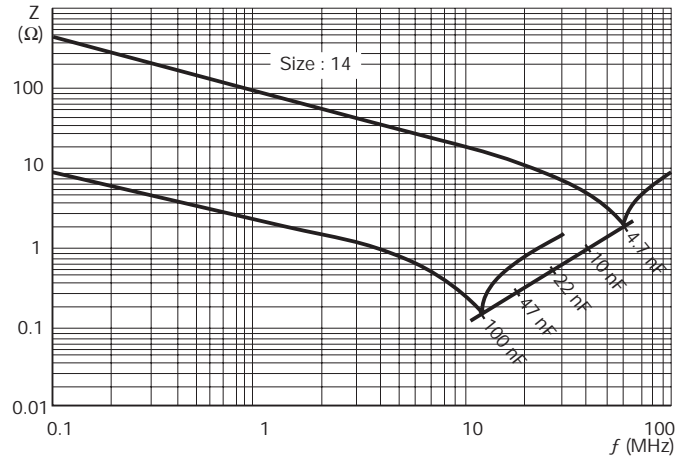

SH 13/18/15/25/30/40



CPM-8 – Axial Leads 63/100/250/400/630/1000 V-

APPLICATIONS

Non-inductive, capacitor for professional use. Flat axial, polyester wrapped, epoxy resin sealed.

Some examples of use:

Oscillating circuit, LF filter, coupling and decoupling, frequency discriminator.

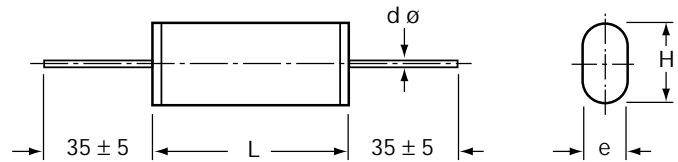

STANDARDIZATION

Generic specifications:

CEI 384-1/CECC 30000/UTE 83100

Sectional specifications:

CEI 384-2/CECC 30400/UTE 83151

On the LNZ 44-04 list:

Complies with type CPM8

millimeters (inches)

e max.	≤ 5	> 5	≥ 7
Ø d ± 0.05 (0.002)	0.6 (0.024)	0.8 (0.031)	1.0 (0.039)

PERFORMANCE CHARACTERISTICS

Protection:	Flat axial leads, polyester wrapped, epoxy resin sealed
Temperature range:	-55°C to +100°C with voltage derating of 1.25%/°C between 85°C and 100°C
Climatic category:	55/100/56
Voltage range:	63 VDC to 1000 VDC
Capacitance range:	1 nF to 22 µF
Tolerances on C _R :	±5%, ±10%, ±20%
Test voltage:	1.6 V _n /2 s
Insulation resistance:	

Measurement condition:

Temperature:	25°C ± 5°C
Duration:	1 minute
Measurement Voltage:	100 V for V _n ≥ 100 V 50 V for V _n < 100 V

Requirements:

For Un ≤ 100 V:	C ≤ 0.33 µF ≥ 15 000 MΩ C > 0.33 µF ≥ 5 000 S
For Un > 100 V:	C ≤ 0.33 µF ≥ 30 000 MΩ C > 0.33 µF ≥ 10 000 S

Tangent of loss angle:

LIMIT VALUES

	C ≤ 0.1 µF	0.1 µF < C ≤ 1 µF	C > 1 µF
1 kHz	8 x 10 ⁻³	8 x 10 ⁻³	10 x 10 ⁻³
10 kHz	15 x 10 ⁻³	15 x 10 ⁻³	
100 Hz	30 x 10 ⁻³		

SH 13/18/15/25/30/40



Range

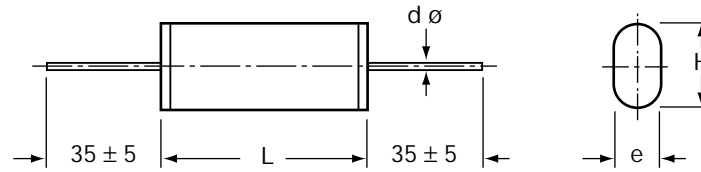

millimeters (inches)

Capacitance	63 V DC / 40 V AC				100 V DC / 63 V AC				250 V DC / 160 V AC			
	Size Code	e	H	L	Size Code	e	H	L	Size Code	e	H	L
0.01 μ F									13	4.0 (0.157)	7.0 (0.276)	13.0 (0.512)
0.015 μ F									13	4.0 (0.157)	7.0 (0.276)	13.0 (0.512)
0.022 μ F					13	4.0 (0.157)	7.0 (0.276)	13.0 (0.512)	13	4.0 (0.157)	8.0 (0.315)	13.0 (0.512)
0.033 μ F					13	4.0 (0.157)	7.0 (0.276)	13.0 (0.512)	13	4.0 (0.157)	8.0 (0.315)	13.0 (0.512)
0.047 μ F					13	4.0 (0.157)	7.0 (0.276)	13.0 (0.512)	13	5.0 (0.197)	8.0 (0.315)	13.0 (0.512)
0.068 μ F					13	4.0 (0.157)	7.0 (0.276)	13.0 (0.512)	13	5.0 (0.197)	8.0 (0.315)	13.0 (0.512)
0.1 μ F					13	4.0 (0.157)	7.0 (0.276)	13.0 (0.512)	18	4.0 (0.157)	8.0 (0.315)	18.0 (0.709)
0.15 μ F					13	4.0 (0.157)	7.0 (0.276)	13.0 (0.512)	18	5.0 (0.197)	9.0 (0.354)	18.0 (0.709)
0.22 μ F	13	4.0 (0.157)	7.0 (0.276)	13.0 (0.512)	13	5.0 (0.197)	8.0 (0.315)	13.0 (0.512)	18	5.0 (0.197)	10.0 (0.394)	18.0 (0.709)
0.33 μ F	13	4.0 (0.157)	7.0 (0.276)	13.0 (0.512)	18	5.0 (0.197)	8.0 (0.315)	18.0 (0.709)	18	6.0 (0.236)	11.0 (0.433)	18.0 (0.709)
0.47 μ F	13	5.0 (0.197)	9.0 (0.354)	13.0 (0.512)	18	5.0 (0.197)	9.0 (0.354)	18.0 (0.709)	25	5.0 (0.197)	12.0 (0.472)	25.0 (0.984)
0.68 μ F	13	6.0 (0.236)	9.0 (0.354)	13.0 (0.512)	18	6.0 (0.236)	9.0 (0.354)	18.0 (0.709)	25	6.0 (0.236)	13.0 (0.512)	25.0 (0.984)
1 μ F	13	6.0 (0.236)	9.0 (0.354)	13.0 (0.512)	13	8.0 (0.315)	11.0 (0.433)	13.0 (0.512)	18	9.0 (0.354)	14.0 (0.551)	18.0 (0.709)
1 μ F	18	5.0 (0.197)	10.0 (0.394)	18.0 (0.709)	18	7.0 (0.276)	11.0 (0.433)	18.0 (0.709)	25	7.0 (0.276)	15.0 (0.591)	25.0 (0.984)
1.5 μ F	13	7.0 (0.276)	10.0 (0.394)	13.0 (0.512)	18	9.0 (0.354)	13.0 (0.512)	18.0 (0.709)	25	9.0 (0.354)	15.0 (0.591)	25.0 (0.984)
1.5 μ F	18	6.5 (0.260)	11.0 (0.433)	18.0 (0.709)	25	6.0 (0.236)	14.0 (0.551)	25.0 (0.984)	30	8.0 (0.315)	16.0 (0.630)	30.0 (1.181)
2.2 μ F	13	9.0 (0.354)	12.0 (0.472)	13.0 (0.512)	18	11.0 (0.433)	15.0 (0.591)	18.0 (0.709)	25	9.0 (0.354)	17.0 (0.669)	25.0 (0.984)
2.2 μ F	18	7.0 (0.276)	12.0 (0.472)	18.0 (0.709)	25	7.0 (0.276)	16.0 (0.630)	25.0 (0.984)	30	10.0 (0.394)	18.0 (0.709)	30.0 (1.181)
3.3 μ F	18	8.5 (0.335)	13.5 (0.531)	18.0 (0.709)	18	13.0 (0.512)	17.0 (0.669)	18.0 (0.709)	25	15.0 (0.591)	19.0 (0.748)	25.0 (0.984)
3.3 μ F	25	6.0 (0.236)	14.0 (0.551)	25.0 (0.984)	25	9.0 (0.354)	16.0 (0.630)	25.0 (0.984)	30	12.0 (0.472)	20.0 (0.787)	30.0 (1.181)
4.7 μ F	18	10.0 (0.394)	15.0 (0.591)	18.0 (0.709)	25	12.0 (0.472)	18.0 (0.709)	25.0 (0.984)	30	16.0 (0.630)	22.0 (0.866)	30.0 (1.181)
4.7 μ F	25	7.0 (0.276)	15.0 (0.591)	25.0 (0.984)	30	10.0 (0.394)	18.0 (0.709)	30.0 (1.181)	40	12.0 (0.472)	27.0 (1.063)	40.0 (1.575)
6.8 μ F	18	14.0 (0.551)	19.0 (0.748)	18.0 (0.709)	25	15.0 (0.591)	21.0 (0.827)	25.0 (0.984)	30	18.0 (0.709)	24.0 (0.945)	30.0 (1.181)
6.8 μ F	25	8.0 (0.315)	16.0 (0.630)	25.0 (0.984)	30	13.0 (0.512)	21.0 (0.827)	30.0 (1.181)	40	11.0 (0.433)	21.0 (0.827)	40.0 (1.575)
10 μ F	25	11.0 (0.433)	18.0 (0.709)	25.0 (0.984)	25	18.0 (0.709)	25.0 (0.984)	25.0 (0.984)	30	21.0 (0.827)	26.0 (1.024)	30.0 (1.181)
10 μ F	30	9.0 (0.354)	17.0 (0.669)	30.0 (1.181)	30	14.0 (0.551)	26.0 (1.024)	30.0 (1.181)	40	14.0 (0.551)	23.0 (0.906)	40.0 (1.575)
15 μ F		upon request				upon request						
22 μ F		upon request				upon request						

SH 13/18/15/25/30/40



Range

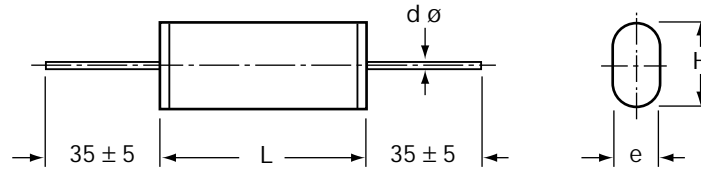

millimeters (inches)

Capacitance	400 V DC / 200 V AC				630 V DC / 220 V AC				1000 V DC / 250 V AC			
	Size Code	e	H	L	Size Code	e	H	L	Size Code	e	H	L
0.01 μ F	13	4.0 (0.157)	8.0 (0.315)	13.0 (0.512)	13	5.0 (0.197)	8.0 (0.315)	13.0 (0.512)	18	5.0 (0.197)	10.0 (0.394)	18.0 (0.709)
0.015 μ F	13	4.0 (0.157)	8.0 (0.315)	13.0 (0.512)	13	5.0 (0.197)	8.0 (0.315)	13.0 (0.512)	18	5.0 (0.197)	10.0 (0.394)	18.0 (0.709)
0.022 μ F	13	5.0 (0.197)	8.0 (0.315)	13.0 (0.512)	13	5.0 (0.197)	8.0 (0.315)	13.0 (0.512)	18	5.5 (0.217)	11.0 (0.433)	18.0 (0.709)
0.033 μ F	13	5.0 (0.197)	8.0 (0.315)	13.0 (0.512)	18	5.0 (0.197)	9.0 (0.354)	18.0 (0.709)	25	5.0 (0.197)	11.0 (0.433)	25.0 (0.984)
0.047 μ F	13	5.0 (0.197)	8.0 (0.315)	13.0 (0.512)	18	6.0 (0.236)	10.0 (0.394)	18.0 (0.709)	25	6.0 (0.236)	12.0 (0.472)	25.0 (0.984)
0.068 μ F	13	5.0 (0.197)	8.0 (0.315)	13.0 (0.512)	18	6.0 (0.236)	12.0 (0.472)	18.0 (0.709)	25	7.0 (0.276)	16.0 (0.630)	25.0 (0.984)
0.1 μ F	18	5.0 (0.197)	9.0 (0.354)	18.0 (0.709)	18	6.0 (0.236)	13.0 (0.512)	18.0 (0.709)	25	9.0 (0.354)	16.0 (0.630)	25.0 (0.984)
0.15 μ F	18	6.0 (0.236)	10.0 (0.394)	18.0 (0.709)	25	6.0 (0.236)	13.0 (0.512)	25.0 (0.984)	30	9.0 (0.354)	16.0 (0.630)	30.0 (1.181)
0.22 μ F	25	5.0 (0.197)	10.0 (0.394)	25.0 (0.984)	25	7.0 (0.276)	15.0 (0.591)	25.0 (0.984)	30	10.0 (0.394)	20.0 (0.787)	30.0 (1.181)
0.33 μ F	25	6.0 (0.236)	12.0 (0.472)	25.0 (0.984)	30	8.0 (0.315)	18.0 (0.709)	30.0 (1.181)	30	14.0 (0.551)	23.0 (0.906)	30.0 (1.181)
0.47 μ F	25	7.0 (0.276)	14.0 (0.551)	25.0 (0.984)	30	11.0 (0.433)	18.0 (0.709)	30.0 (1.181)	40	10.0 (0.394)	22.0 (0.866)	40.0 (1.575)
0.68 μ F	25	8.0 (0.315)	16.0 (0.630)	25.0 (0.984)	30	12.0 (0.472)	21.0 (0.827)	30.0 (1.181)				
1 μ F	25	11.0 (0.433)	18.0 (0.709)	25.0 (0.984)	25	11.0 (0.433)	20.0 (0.787)	25.0 (0.984)				
1 μ F	30	10.0 (0.394)	17.0 (0.669)	30.0 (1.181)	30	14.0 (0.551)	23.0 (0.906)	30.0 (1.181)				
1.5 μ F	30	11.0 (0.433)	20.0 (0.787)	30.0 (1.181)	30	16.0 (0.630)	25.0 (0.984)	30.0 (1.181)				
1.5 μ F	40	9.0 (0.354)	18.0 (0.709)	40.0 (1.575)	40	13.0 (0.512)	25.0 (0.984)	40.0 (1.575)				
2.2 μ F	30	12.0 (0.472)	22.0 (0.866)	30.0 (1.181)	30	19.0 (0.748)	27.0 (1.063)	30.0 (1.181)				
2.2 μ F	40	10.0 (0.394)	20.0 (0.787)	40.0 (1.575)	40	15.0 (0.591)	30.0 (1.181)	40.0 (1.575)				
3.3 μ F	30	13.0 (0.512)	25.0 (0.984)	30.0 (1.181)								
3.3 μ F	40	12.0 (0.472)	23.0 (0.906)	40.0 (1.575)								
4.7 μ F	30	15.0 (0.591)	26.0 (1.024)	30.0 (1.181)								
4.7 μ F	40	14.0 (0.551)	26.0 (1.024)	40.0 (1.575)								
6.8 μ F												
6.8 μ F												
10 μ F												
10 μ F												
15 μ F												
15 μ F												
22 μ F												

BULK: Quantity Per Voltage

Capacitance	Voltage					
	63 V	100 V	250 V	400 V	630V	1000 V
0.01 μ F			2000	2000	2000	1250
0.015 μ F			2000	2000	2000	1250
0.022 μ F		2000	2000	2000	1250	1250
0.033 μ F		2000	2000	2000	1250	700
0.047 μ F		2000	1500	1500	1250	700
0.068 μ F		2000	1250	1250	1250	700
0.10 μ F		2000	2000	1250	1250	700
0.15 μ F		2000	1250	1250	700	300
0.22 μ F	2000	2000	1250	700	700	200
0.33 μ F	2000	1250	1250	700	300	200
0.47 μ F	2000	1250	700	700	250	200
0.38 μ F	2000	1250	700	700	200	
1 μ F	2000	1250	700	300	200	
1.5 μ F	1250	700	300	200	200	
2.2 μ F	750	700	250	200	200	
3.3 μ F	700	700	200	200		
4.7 μ F	700	300	200	150		
6.8 μ F	700	250	150			
10 μ F	300	200	150			

APPLICATIONS

Non-inductive, insulated capacitor for professional use. Cylindrical axial leads, polyester wrapped, epoxy resin sealed.

Some examples of use:

Oscillating circuit, LF filter, coupling and decoupling, frequency discriminator.

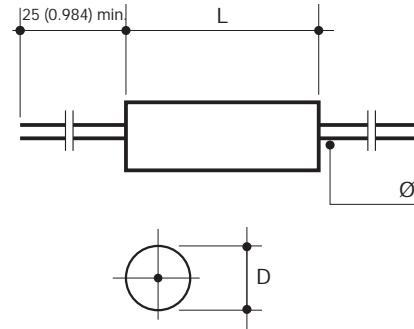

STANDARDIZATION

Generic specifications:

CEI 384-1/CECC 30000/UTE 83100

Sectional specifications:

CEI 384-2/CECC 30400/UTE 83151

On the LNZ 44-04 list:

Complies with type CPM72

NOTE: For new design, please refer to SG series (optimized range)

DIMENSIONS:

millimeters (inches)

Size Code	L max.	D max.	$\varnothing^{+10\%}_{-0.05}$	Observations
10	12.0 (0.472)	5.0 (0.197)	0.6 (0.024)	$1\text{nF} \leq C_R \leq 100\text{nF}$
13	14.5 (0.571)	5.0 ... 7.5 (0.197 ... 0.295)	0.6 (0.024)	$4.7\text{nF} \leq C_R \leq 300\text{nF}$
18	20.0 (0.787)	7.5 ... 10.0 (0.295 ... 0.394)	0.8 (0.031)	$33\text{nF} \leq C_R \leq 1\mu\text{F}$
27	27.5 (1.083)	8.75 ... 12.5 (0.344 ... 0.492)	0.8 (0.031)	$100\text{nF} \leq C_R \leq 3.3\mu\text{F}$
31	33.0 (1.299)	12.5 ... 21.5 (0.492 ... 0.846)	.08 (0.031)	$330\text{nF} \leq C_R \leq 10\mu\text{F}$

HOW TO ORDER

S9 13



Type

4



Class

G



Voltage

0104



Capacitance Value

K



Tolerance

--



Suffix
Tape and Reel
See page 47

PERFORMANCE CHARACTERISTICS

Climatic category:	55/100/21 - Performance Class 1
Capacitance range:	C_R 1 nF to 10 μF
Tolerances on C_R (assoc. series):	$\pm 5\%$, $\pm 10\%$, $\pm 20\%$ (E6) (other values on request)
Nominal voltages:	V_{R-} 100/250/400/630 V V_{R-} 40/100/160/200 V
Category voltage:	$V_C = 0.75 V_{R-}$ at 100°C
Test voltage:	$V_e = 1.6 V_{R-}$
Tangent of loss angle:	D.F. (see page 4)
Insulation resistance:	IR (see page 5)

MARKING

Logo - CPM72B
Capacitance and tolerance (CEI 62 code)
Nominal voltage
Date of manufacture
2 letter code
(year - month) according to CEI 62 and available space

NOMINAL VOLTAGE (V_R) AND CAPACITANCE VALUES (C_R) DEPENDING ON THE DIMENSIONS

Size Code	DIMENSIONS: millimeters (inches)			Reference			
				S9			
	Max L	Max D	\varnothing <small>+10% -0.05</small>	V_R / V_{R-}			
				100/40	250/100	400/160	630/200
	Range of Capacitance (C_R min. ... max.)						
10	12.0 (0.472)	5.0 (0.197)	0.6 (0.024)	33 nF ... 100 nF	10 nF ... 22 nF	4.7 nF/6.8 nF	1 nF ... 3.3 nF
13	14.5 (0.571)	5.0 (0.197)	0.6 (0.024)	-	33 nF	10 nF/15nF	4.7 nF/6.8 nF
	14.5 (0.571)	6.25 (0.246)	0.6 (0.024)	150 nF	47 nF/68 nF	22 nF/33 nF	10 nF
	14.5 (0.571)	7.5 (0.295)	0.6 (0.024)	220 nF/330 nF	100 nF	47 nF	15 nF/22 nF
18	20.0 (0.787)	7.5 (0.295)	0.8 (0.031)	470 nF	150 nF/220 nF	68 nF	33 nF
	20.0 (0.787)	8.75 (0.344)	0.8 (0.031)	680 nF	330 nF	100 nF	47 nF
	20.0 (0.787)	10.0 (0.394)	0.8 (0.031)	1 μ F	470 nF	150 nF	68 nF
27	27.5 (1.083)	8.75 (0.344)	0.8 (0.031)	-	-	220 nF	100 nF
	27.5 (1.083)	10.0 (0.394)	0.8 (0.031)	1.5 μ F	680 nF	330 nF	150 nF
	27.5 (1.083)	11.25 (0.443)	0.8 (0.031)	2.2 μ F	1 μ F	-	-
	27.5 (1.083)	12.5 (0.492)	0.8 (0.031)	3.3 μ F	-	470 nF	220 nF
31	33.0 (1.299)	12.5 (0.492)	0.8 (0.031)	-	1.5 μ F	680 nF	330 nF
	33.0 (1.299)	13.5 (0.531)	0.8 (0.031)	4.7 μ F	2.2 μ F	-	-
	33.0 (1.299)	15.0 (0.591)	0.8 (0.031)	-	-	1 μ F	470 nF
	33.0 (1.299)	16.5 (0.650)	0.8 (0.031)	6.8 μ F	3.3 μ F	-	-
	33.0 (1.299)	17.5 (0.689)	0.8 (0.031)	-	-	1.5 μ F	-
	33.0 (1.299)	18.75 (0.738)	0.8 (0.031)	-	-	-	680 nF
	33.0 (1.299)	20.0 (0.787)	0.8 (0.031)	10 μ F	4.7 μ F	-	-
	33.0 (1.299)	21.25 (0.837)	0.8 (0.031)	-	-	2.2 μ F	1 μ F

CHARACTERISTIC CURVES

Influence of the frequency on the impedance (room temperature).

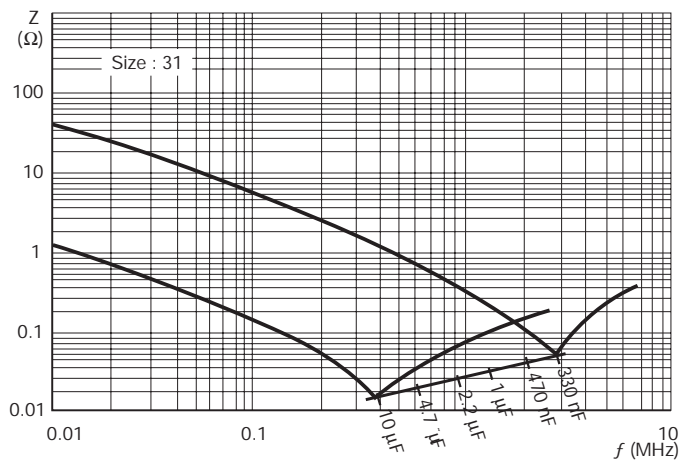
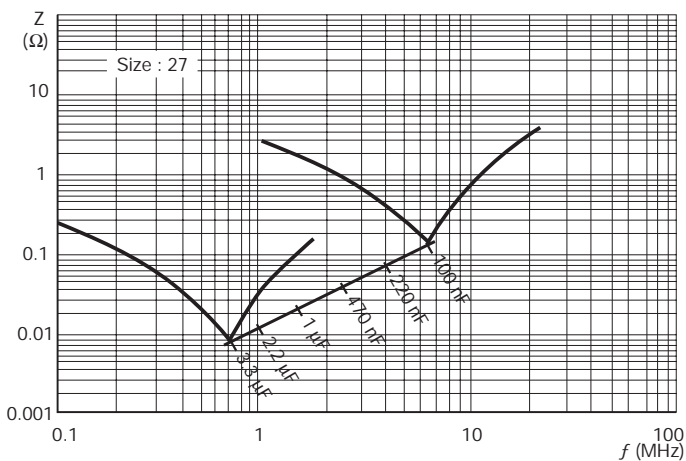
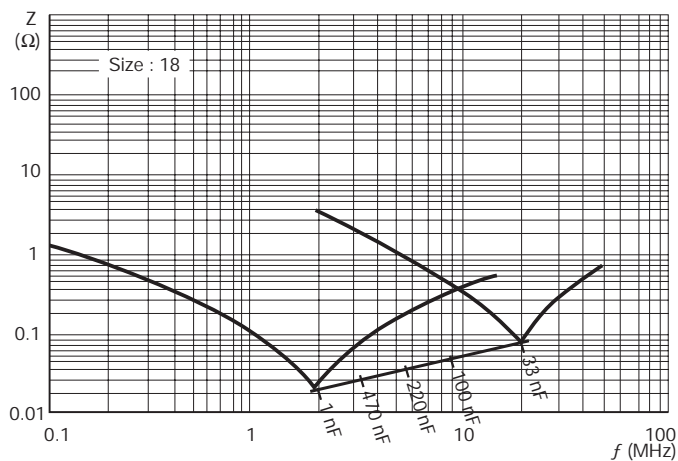
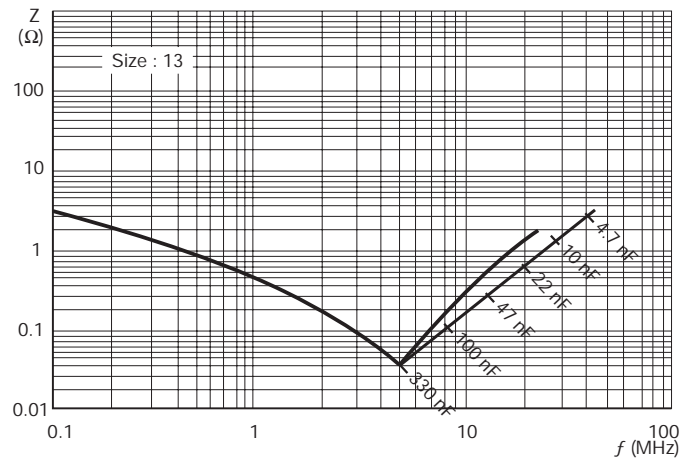
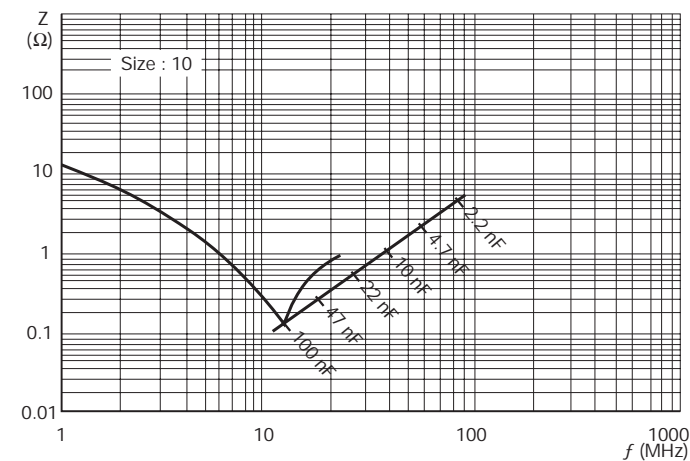

SG 13/18/25/30/40



CPM72 – Axial Leads 63/100/250/400/630/1000 V-

APPLICATIONS

Non-inductive, insulated capacitor for professional use. Cylindrical axial leads, polyester wrapped, epoxy resin sealed.

Some examples of use:

Oscillating circuit, LF filter, coupling and decoupling, frequency discriminator.

STANDARDIZATION

Generic specifications:

CEI 384-1/CECC 30000/UTE 83100

Sectional specifications:

CEI 384-2/CECC 30400/UTE 83151

On the LNZ 44-04 list:

Complies with type CPM72

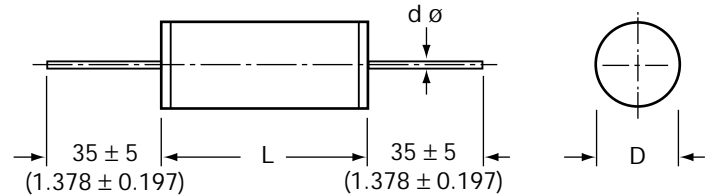

PERFORMANCE CHARACTERISTICS

Protection: Cylindrical axial leads, polyester wrapped, epoxy resin sealed

Temperature range: -55°C to +100°C with voltage derating of 1.25%/°C between 85°C and 100°C

Climatic category: 55/100/56

Voltage range: 63 VDC to 1000 VDC

Capacitance range: 10 nF to 22 µF

Tolerances on C_p : ±5%, ±10%, ±20%

Test voltage: 1.6 $V_n / 2$ s

Insulation resistance:

Measurement condition:

Temperature: 25°C ± 5°C

Duration: 1 minute

Measurement Voltage: 100 V for $V_n \geq 100$ V
50 V for $V_n < 100$ V

Requirements:

For $U_n \leq 100$ V: $C \leq 0.33 \mu\text{F} \geq 15\,000 \text{ M}\Omega$
 $C > 0.33 \mu\text{F} \geq 5\,000 \text{ S}$

For $U_n > 100$ V: $C \leq 0.33 \mu\text{F} \geq 30\,000 \text{ M}\Omega$
 $C > 0.33 \mu\text{F} \geq 10\,000 \text{ S}$

Tangent of loss angle:

LIMIT VALUES

	$C \leq 0.1 \mu\text{F}$	$0.1 \mu\text{F} < C \leq 1 \mu\text{F}$	$C > 1 \mu\text{F}$
1 kHz	8×10^{-3}	8×10^{-3}	10×10^{-3}
10 kHz	15×10^{-3}	15×10^{-3}	
100 Hz	30×10^{-3}		

millimeters (inches)

D max.	≤ 8mm	> 8mm	≥ 15mm
∅ d ± 0.05 (0.002)	0.6 (0.024)	0.8 (0.031)	1.0 (0.039)

SG 13/18/25/30/40



Range

millimeters (inches)

Capacitance	63 V DC / 40 V AC			100 V DC / 63 V AC			250 V DC / 160 V AC		
	Size Code	D	L	Size Code	D	L	Size Code	D	L
0.01 μ F									
0.015 μ F									
0.022 μ F									
0.033 μ F									
0.047 μ F							13	6.5 (0.256)	13.0 (0.512)
0.068 μ F				13	6.5 (0.256)	13.0 (0.512)	13	7.0 (0.276)	13.0 (0.512)
0.1 μ F				13	6.5 (0.256)	13.0 (0.512)	13	7.0 (0.276)	13.0 (0.512)
0.15 μ F				13	6.5 (0.256)	13.0 (0.512)	13	7.5 (0.295)	13.0 (0.512)
0.22 μ F	13	6.5 (0.256)	13.0 (0.512)	13	6.5 (0.256)	13.0 (0.512)	13	8.0 (0.315)	13.0 (0.512)
0.33 μ F	13	6.5 (0.256)	13.0 (0.512)	18	6.0 (0.236)	18.0 (0.709)	18	8.0 (0.315)	18.0 (0.709)
0.47 μ F	13	7.0 (0.276)	13.0 (0.512)	18	7.0 (0.276)	18.0 (0.709)	18	9.0 (0.354)	18.0 (0.709)
0.68 μ F	13	7.0 (0.276)	13.0 (0.512)	18	8.0 (0.315)	18.0 (0.709)	18	10.0 (0.394)	18.0 (0.709)
0.68 μ F	18	6.5 (0.256)	18.0 (0.709)						
1 μ F	13	8.0 (0.315)	13.0 (0.512)	13	11.0 (0.433)	13.0 (0.512)	18	12.0 (0.472)	18.0 (0.709)
1 μ F	18	7.5 (0.276)	18.0 (0.709)	18	9.0 (0.354)	18.0 (0.709)	25	10.0 (0.394)	25.0 (0.984)
1.5 μ F	13	8.0 (0.315)	13.0 (0.512)	18	11.0 (0.433)	18.0 (0.709)	25	10.0 (0.394)	25.0 (0.984)
1.5 μ F	18	8.5 (0.335)	18.0 (0.709)	25	9.0 (0.354)	25.0 (0.984)	30	11.0 (0.433)	30.0 (1.181)
2.2 μ F	18	9.5 (0.374)	18.0 (0.709)	18	13.0 (0.512)	18.0 (0.709)	25	14.0 (0.551)	25.0 (0.984)
2.2 μ F	25	8.5 (0.335)	25.0 (0.984)	25	11.0 (0.433)	25.0 (0.984)	30	13.0 (0.512)	30.0 (1.181)
3.3 μ F	18	11.0 (0.433)	18.0 (0.709)	18	15.0 (0.591)	18.0 (0.709)	25	17.0 (0.669)	25.0 (0.984)
3.3 μ F	25	10.0 (0.394)	25.0 (0.984)	25	12.0 (0.472)	25.0 (0.984)	30	14.0 (0.551)	30.0 (1.181)
4.7 μ F	18	13.0 (0.512)	18.0 (0.709)	25	15.0 (0.591)	25.0 (0.984)	30	18.0 (0.709)	30.0 (1.181)
4.7 μ F	25	12.0 (0.472)	25.0 (0.984)	30	14.0 (0.551)	30.0 (1.181)	40	11.0 (0.433)	40.0 (1.575)
6.8 μ F	25	15.0 (0.591)	25.0 (0.984)	25	17.0 (0.669)	25.0 (0.984)	30	21.0 (0.827)	30.0 (1.181)
6.8 μ F	30	12.0 (0.472)	30.0 (1.181)	30	16.0 (0.630)	30.0 (1.181)	40	13.0 (0.512)	40.0 (1.575)
10 μ F	25	17.0 (0.669)	25.0 (0.984)	30	18.0 (0.709)	30.0 (1.181)	30	23.0 (0.906)	30.0 (1.181)
10 μ F	30	14.5 (0.571)	30.0 (1.181)	40	16.0 (0.630)	40.0 (1.575)	40	14.0 (0.551)	40.0 (1.575)
15 μ F		upon request			upon request				
22 μ F		upon request			upon request				

SG 13/18/25/30/40



Range

Capacitance	400 V DC / 200 V AC			630 V DC / 220 V AC			1000 V DC / 250 V AC		
	Size Code	D	L	Size Code	D	L	Size Code	D	L
0.01 μ F				13	6.5 (0.256)	13.0 (0.512)	13	8.0 (0.315)	13.0 (0.512)
0.015 μ F				13	7.0 (0.276)	13.0 (0.512)	18	8.0 (0.315)	18.0 (0.709)
0.022 μ F	13	6.5 (0.256)	13.0 (0.512)	13	8.0 (0.315)	13.0 (0.512)	18	9.0 (0.354)	18.0 (0.709)
0.033 μ F	13	6.5 (0.256)	13.0 (0.512)	18	6.5 (0.256)	18.0 (0.709)	18	11.0 (0.433)	18.0 (0.709)
0.047 μ F	13	7.5 (0.276)	13.0 (0.512)	18	7.0 (0.276)	18.0 (0.709)	18	12.0 (0.472)	18.0 (0.709)
0.068 μ F	13	8.0 (0.315)	13.0 (0.512)	18	8.0 (0.315)	18.0 (0.709)	25	11.0 (0.433)	25.0 (0.984)
0.1 μ F	18	7.0 (0.276)	18.0 (0.709)	18	10.0 (0.394)	18.0 (0.709)	25	13.0 (0.512)	25.0 (0.984)
0.15 μ F	18	8.5 (0.335)	18.0 (0.709)	25	10.0 (0.394)	25.0 (0.984)	30	14.0 (0.551)	30.0 (1.181)
0.22 μ F	25	9.0 (0.354)	25.0 (0.984)	25	12.5 (0.492)	25.0 (0.984)	30	16.0 (0.630)	30.0 (1.181)
0.33 μ F	25	9.5 (0.374)	25.0 (0.984)	25	13.0 (0.512)	25.0 (0.984)	40	16.0 (0.630)	40.0 (1.575)
0.47 μ F	25	11.0 (0.433)	25.0 (0.984)	25	14.0 (0.551)	25.0 (0.984)	40	19.0 (0.748)	40.0 (1.575)
0.68 μ F	30	10.0 (0.394)	30.0 (1.181)	30	12.0 (0.472)	30.0 (1.181)	40	21.0 (0.827)	40.0 (1.575)
0.68 μ F									
1 μ F	25	16.0 (0.630)	25.0 (0.984)	30	14.0 (0.551)	30.0 (1.181)			
1 μ F	30	11.0 (0.433)	30.0 (1.181)	40	15.0 (0.591)	40.0 (1.575)			
1.5 μ F	30	12.0 (0.472)	30.0 (1.181)	30	16.0 (0.630)	30.0 (1.181)			
1.5 μ F	40	14.0 (0.551)	40.0 (1.575)	40	16.0 (0.630)	40.0 (1.575)			
2.2 μ F	30	13.0 (0.512)	30.0 (1.181)	30	17.0 (0.669)	30.0 (1.181)			
2.2 μ F	40	17.0 (0.669)	40.0 (1.575)	40	18.0 (0.709)	40.0 (1.575)			
3.3 μ F	30	16.0 (0.630)	30.0 (1.181)						
3.3 μ F	40	20.0 (0.787)	40.0 (1.575)						
4.7 μ F									
4.7 μ F									
6.8 μ F									
6.8 μ F									
10 μ F									
10 μ F									
15 μ F									
22 μ F									

Packaging

BULK: Quantity Per Voltage

Suffix --

Capacitance	Voltage					
	63 V	100 V	250 V	400 V	630 V	1000 V
0.01 μ F					2000	1250
0.015 μ F					2000	1000
0.022 μ F				2000	1250	750
0.033 μ F				2000	1250	500
0.047 μ F			2000	1500	1250	750
0.068 μ F		2000	2000	1250	1000	500
0.10 μ F		2000	2000	1250	1000	500
0.15 μ F		2000	1500	1000	500	300
0.22 μ F	2000	2000	1250	500	300	200
0.33 μ F	2000	1250	1000	500	300	150
0.47 μ F	2000	1250	750	500	300	150
0.68 μ F	2000	1000	750	400	400	100
1 μ F	1500	750	750	400	300	
1.5 μ F	1500	500	500	400	200	
2.2 μ F	900	400	300	300	200	
3.3 μ F	800	400	300	150		
4.7 μ F	800	400	200			
6.8 μ F	250	400	150			
10 μ F	250	200	150			

AMMOPACK (upon request)

Suffix EN

\varnothing Capacitor (mm)	5.0 ... 9.0	10.0 ... 14.0	15.0 ... 19.0
Space between capacitors	10 \pm 0.5	15 \pm 0.75	20 \pm 1.0

Capacitance	Voltage					
	63 V	100 V	250 V	400 V	630 V	1000 V
0.01 μ F					1000	800
0.015 μ F					950	800
0.022 μ F				1000	800	700
0.033 μ F				1000	1000	400
0.047 μ F			1000	900	950	300
0.068 μ F		1000	950	800	800	400
0.10 μ F		1000	950	950	450	300
0.15 μ F		1000	900	800	450	300
0.22 μ F	1000	1000	800	700	350	200
0.33 μ F	1000	1100	800	700	300	200
0.47 μ F	950	950	700	400	300	
0.68 μ F	1000	800	450	450	350	
1 μ F	1000	400	300	200	300	
1.5 μ F	800	400	450	350	200	
2.2 μ F	700	300	300	300	200	
3.3 μ F	400	300	200	200		
4.7 μ F	300	300	400			
6.8 μ F	200	200	300			
10 μ F	200	200	300			

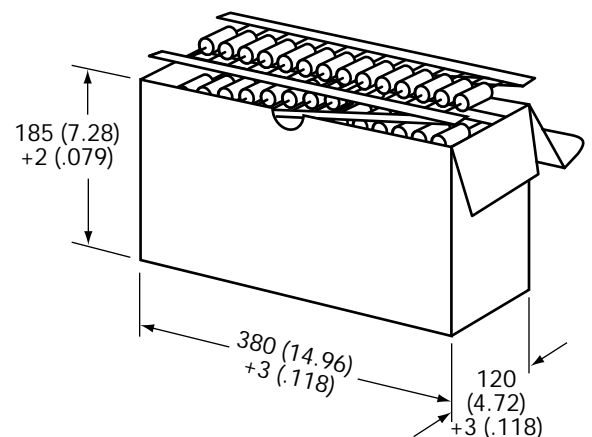
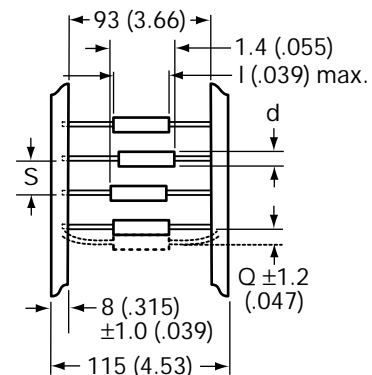

ST 22/36



Axial Leads 630 V- ... 10,000 V-

APPLICATIONS

Non-inductive, insulated capacitor. Cylindrical, axial leads, polyester wrapped, epoxy resin sealed.

Some examples of use:

High voltage filtering, TV line recuperation.

SPACELAB qualified.

Important: In frequency the voltages can be limited by the nominal RMS current.

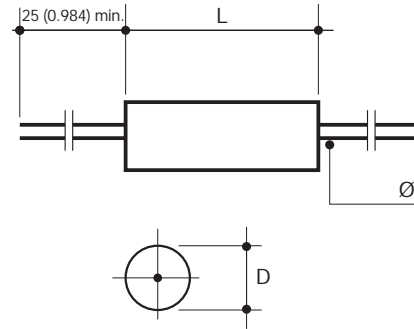

DIMENSIONS:

millimeters (inches)

Size Code	L max.	D max.	$\varnothing^{+10\%}_{-0.05}$	Observations
22	22.0 (0.866)	10.0 ... 17.5 (0.394 ... 0.689)	0.8 (0.031)	$150\text{pF} \leq C_R \leq 100\text{nF}$
36	36.0 (1.417)	10.0 ... 27.5 (0.394 ... 1.083)	1.0 (0.039)	$100\text{pF} \leq C_R \leq 1.5\mu\text{F}$

HOW TO ORDER

ST 36



Type

4



Class

V



Voltage

0102



Capacitance Value

M



Tolerance

--



Suffix
Tape and Reel
See page 47

PERFORMANCE CHARACTERISTICS

Climatic category: 40/085/21 - Performance Class 1

Capacitance range: C_R 100 pF to 1.5 μF

Tolerances on C_R (assoc. series): $\pm 5\%$, $\pm 10\%$, $\pm 20\%$ (E6) (other values on request)

Nominal voltages: V_{R-} 630 V to 10,000 V

Test voltage: $V_e = 1.25 V_{R-} / 1 \text{ mn}$

Tangent of loss angle: D.F. (see page 4)

Insulation resistance: IR (see page 5)

MARKING

Logo - IE---

Capacitance and tolerance (CEI 62 code)

Nominal voltage

Date of manufacture

2 letter code

(year - month) according to CEI 62

and available space

NOMINAL VOLTAGE (V_R) AND CAPACITANCE VALUES (C_R) DEPENDING ON THE DIMENSIONS

Size Code	DIMENSIONS: millimeters (inches)			Reference						
				ST						
				V_R						
				630	1,000	1,600	2,500	5,000	6,300	10,000
Range of Capacitances (C_R min. ... max.)										
22	22.0 (0.866)	10.0 (0.394)	0.8 (0.031)	-	15 nF/22 nF	6.8 nF ... 15 nF	2.2 nF ... 4.7 nF	150 pF/220 pF	-	-
	22.0 (0.866)	12.5 (0.492)	0.8 (0.031)	-	33 nF/47 nF	22 nF	6.8 nF	330 pF/470 pF	-	-
	22.0 (0.866)	15.0 (0.591)	0.8 (0.031)	-	68 nF	33 nF	10 nF/15 nF	680 pF	-	-
	22.0 (0.866)	17.5 (0.689)	0.8 (0.031)	-	100 nF	47 nF/68 nF	22 nF	1 nF	-	-
36	36.0 (1.417)	10.0 (0.394)	1.0 (0.031)	-	47 nF	15 nF... 33 nF	6.8 nF ... 10 nF	1.5 nF/2.2 nF	1 nF	100 pF/220 pF
	36.0 (1.417)	12.5 (0.492)	1.0 (0.031)	-	68 nF/100 nF	47 nF	15 nF/22 nF	3.3 nF/4.7 nF	1.5 nF	330 pF
	36.0 (1.417)	15.0 (0.591)	1.0 (0.031)	-	150 nF	68 nF/100 nF	33 nF	6.8 nF	2.2 nF/3.3 nF	470 pF/680 pF
	36.0 (1.417)	17.5 (0.689)	1.0 (0.031)	-	220 nF	150 nF	47 nF	10 nF	4.7 nF	1 nF
	36.0 (1.417)	20.0 (0.787)	1.0 (0.031)	-	330 nF	-	68 nF	15 nF	-	-
	36.0 (1.417)	22.5 (0.886)	1.0 (0.031)	1 μ F	470 nF	220 nF	100 nF	-	6.8 nF	1.5 nF
	36.0 (1.417)	25.0 (0.984)	1.0 (0.031)	1.5 μ F	-	330 nF	-	22 nF	10 nF	2.2 nF
	36.0 (1.417)	27.5 (1.083)	1.0 (0.031)	-	680 nF	-	150 nF	33 nF	-	-

CHARACTERISTIC CURVES

Influence of the frequency on the impedance (room temperature).

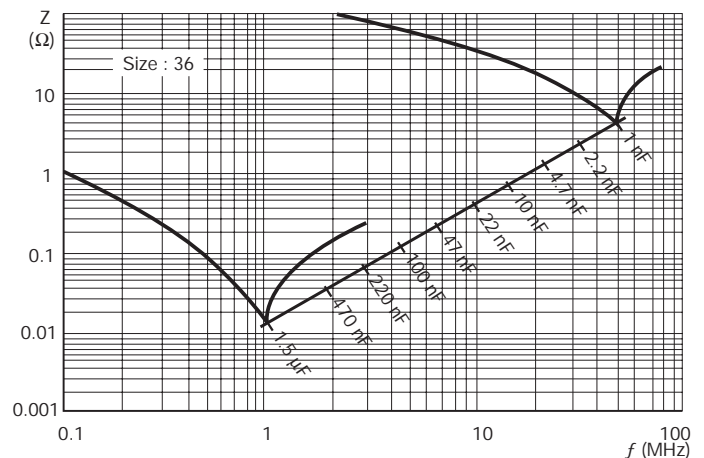
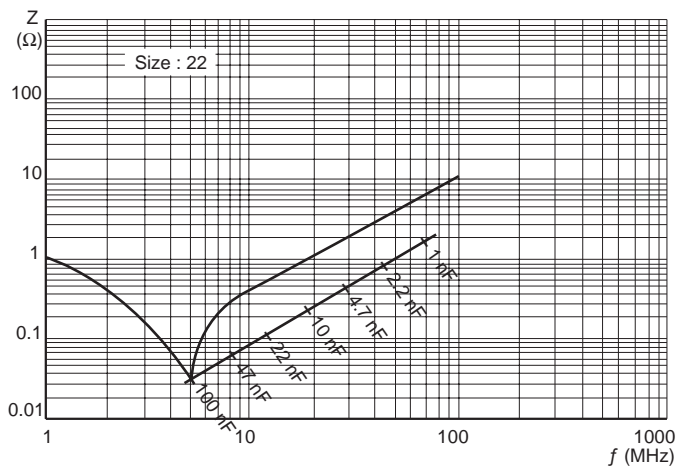

S4 07/10/15/27 – S8 10/14/18/31
 S9 10/13/18/27/31 – ST 22/36



Bulk	M.O.Q. = 200
------	--------------

millimeters (inches)

Tape & Reel	Ø capacitor	Quantities	Pitch
Suffix: GA & GB	< 4.0 (0.0 < 0.157)	1800	10.0 (0.394)
	4 < Ø ≤ 6 (0.161 < Ø ≤ 0.236)	1200	10.0 (0.394)
	6 < Ø ≤ 8 (0.240 < Ø ≤ 0.315)	1000	10.0 (0.394)
	8 < Ø ≤ 9 (0.319 < Ø ≤ 0.354)	800	10.0 (0.394)
Suffix: GA	9 < Ø ≤ 14.5 (0.358 < Ø ≤ 0.571)	300	20.0 (0.787)

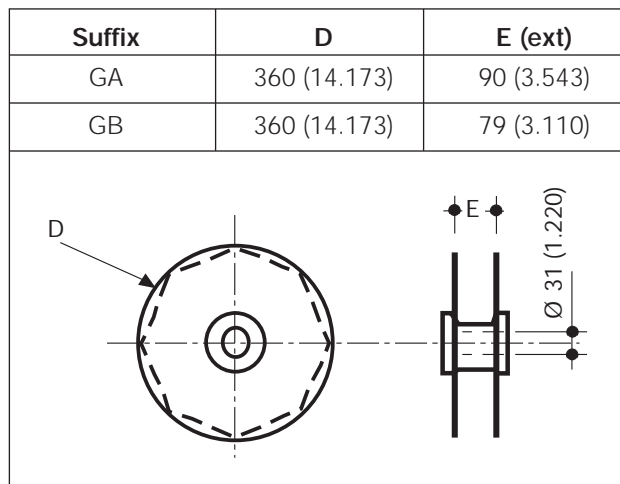

Guide for Customer's Specific Requirements

PRESENTATION	ELECTRICAL CHARACTERISTICS	
<p>- Required shape (rectangular or cylindrical case - molded unit, etc.)</p> <p>_____</p> <p>_____</p> <p>_____</p>	<p>Max. and min. operating temperatures from _____ to _____ °C</p>	
<p>- Max. dimensions</p> <p>_____</p> <p>_____</p> <p>_____</p>	<p>Max. and min. storage temperatures from _____ to _____ °C</p>	
<p>- Required output terminals type</p> <p>_____</p> <p>_____</p>	<p>Capacitance/Tolerance C _____ μF _____ %</p>	
<p>- One plate connected or not to the case</p> <p>_____</p> <p>_____</p> <p>_____</p>	<p>Max. operating voltages V_R DC _____ (DC and AC) V_R RMS _____ V (F _____ Hz)</p>	
<p>- Environment</p> <p>_____</p> <p>_____</p> <p>_____</p>	<p>Max. overvoltages V_S _____ V - Duration t _____ ms - Quantity N _____ - Frequency F _____ Hz</p>	
<p>- Drawing (if necessary)</p> <p>_____</p> <p>_____</p> <p>_____</p>	<p>Test voltage between terminals V_e DC _____ V V_e RMS _____ V (F _____ Hz)</p>	
<p>Marking</p> <p>Standard _____ <input type="checkbox"/></p> <p>Other _____ <input type="checkbox"/></p> <p>_____</p>	<p>Test voltage between shorted terminals and case V_i DC _____ V V_i RMS _____ V (F = 50 Hz)</p>	
<p>Packaging</p> <p>Bulk _____ <input type="checkbox"/></p> <p>One tape on reel _____ <input type="checkbox"/></p> <p>_____</p>	<p>Max. currents</p> <p>- Peak I_{cr} _____ A - RMS I/RMS _____ A - Frequency F _____ Hz</p>	
	<p>Voltage gradient $(dv/dt)_R$ _____ V/μs</p>	
	<p>Application: Diagram of the circuit</p>	<p>Other information (resistive (or) inductive coupling, ... Waveforms, etc.)</p> <p>_____</p> <p>_____</p> <p>_____</p> <p>_____</p> <p>_____</p> <p>_____</p> <p>_____</p> <p>_____</p> <p>_____</p> <p>_____</p> <p>_____</p>

Normalized Series and Associated Values

E 6 ±20%	E 12 ±10%	E 24 ±5%	E 48 ±2%	E 96 ±1%		
100	100	100	100	100		
			102	102		
			105	105		
			107	107		
		110	110	110		
			113	113		
			115	115		
	120	120	120	121	121	
				124	124	
		130	127	127	127	
				130	130	
				133	133	
			140	137	137	
				140	140	
				143	143	
		150	150	150	147	147
					150	150
160	154			154		
	158			158		
	162			162		
180	180		166	166		
			169	169		
			174	174		
			178	178		
			187	187		
200	200	191	191			
		196	196			
		200	200			
		205	205			
		210	210			
		215	215			
		221	221			
220	220	220	226	226		
			232	232		
			237	237		
		240	243	243		
			249	249		
			255	255		
	270	270	261	261		
			267	267		
			274	274		
			280	280		
			287	287		
			294	294		
			301	301		
309	309					

E 6 ±20%	E 12 ±10%	E 24 ±5%	E 48 ±2%	E 96 ±1%				
330	330	330	316	316				
			324	324				
			332	332				
			340	340				
			360	348	348			
				357	357			
				365	365			
			390	390	374	374		
					383	383		
					392	392		
					402	402	402	
						412	412	
						422	422	
					430	430	422	422
							432	432
							442	442
							453	453
464	464							
470	470	470	464	464				
			475	475				
			487	487				
			499	499				
			510	511	511			
				523	523			
				536	536			
				549	549			
				562	562			
			560	560	560	576	576	
						590	590	
						604	604	
						619	619	
634	634							
649	649							
665	665							
680	680	680	681	681				
			698	698				
			715	715				
			732	732				
			750	750	750			
				768	768			
				787	787			
			820	820	820	806	806	
						825	825	
						845	845	
						866	866	
887	887							
910	909	909						
	931	931						
	953	953						
	976	976						

USA

AVX Myrtle Beach, SC Corporate Offices

Tel: 843-448-9411
FAX: 843-448-1943

AVX Northwest, WA

Tel: 360-669-8746
FAX: 360-699-8751

AVX North Central, IN

Tel: 317-848-7153
FAX: 317-844-9314

AVX Northeast, MA

Tel: 508-485-8114
FAX: 508-485-8471

AVX Mid-Pacific, CA

Tel: 408-436-5400
FAX: 408-437-1500

AVX Southwest, AZ

Tel: 602-539-1496
FAX: 602-539-1501

AVX South Central, TX

Tel: 972-669-1223
FAX: 972-669-2090

AVX Southeast, NC

Tel: 919-878-6357
FAX: 919-878-6462

AVX Canada

Tel: 905-564-8959
FAX: 905-564-9728

EUROPE

AVX Limited, England European Headquarters

Tel: ++44 (0)1252 770000
FAX: ++44 (0)1252 770001

AVX S.A., France

Tel: ++33 (1) 69.18.46.00
FAX: ++33 (1) 69.28.73.87

AVX GmbH, Germany - AVX

Tel: ++49 (0) 8131 9004-0
FAX: ++49 (0) 8131 9004-44

AVX GmbH, Germany - Elco

Tel: ++49 (0) 2741 2990
FAX: ++49 (0) 2741 299133

AVX srl, Italy

Tel: ++390 (0)2 614571
FAX: ++390 (0)2 614 2576

AVX sro, Czech Republic

Tel: ++420 (0)467 558340
FAX: ++420 (0)467 558345

ASIA-PACIFIC

AVX/Kyocera, Singapore Asia-Pacific Headquarters

Tel: (65) 258-2833
FAX: (65) 350-4880

AVX/Kyocera, Hong Kong

Tel: (852) 2-363-3303
FAX: (852) 2-765-8185

AVX/Kyocera, Korea

Tel: (82) 2-785-6504
FAX: (82) 2-784-5411

AVX/Kyocera, Taiwan

Tel: (886) 2-2516-7010
FAX: (886) 2-2506-9774

AVX/Kyocera, China

Tel: (86) 21-6249-0314-16
FAX: (86) 21-6249-0313

AVX/Kyocera, Malaysia

Tel: (60) 4-228-1190
FAX: (60) 4-228-1196

Elco, Japan

Tel: 045-943-2906/7
FAX: 045-943-2910

Kyocera, Japan - AVX

Tel: (81) 75-604-3426
FAX: (81) 75-604-3425

Kyocera, Japan - KDP

Tel: (81) 75-604-3424
FAX: (81) 75-604-3425

Contact:



<http://www.avxcorp.com>

S-MPFDC13M599-C