

4

**QUAD PROGRAMMABLE OPERATIONAL AMPLIFIER
 QUAD PROGRAMMABLE COMPARATOR
 PROGRAMMABLE DUAL OP AMP/DUAL COMPARATOR**

The MC14573, MC14574, and MC14575 are a family of quad operational low power amplifiers and comparators using the complementary P-channel and N-channel enhancement MOS devices in a single monolithic structure. The operating current is externally programmed with a resistor to provide a choice in the tradeoff of power dissipation and slew rates. The operational amplifiers are internally compensated.

These low cost units are excellent building blocks for consumer, industrial, automotive and instrument applications. Active filters, voltage reference, function generators, oscillators, limit set alarms, TTL-to-CMOS or CMOS-to-CMOS up converters, A-to-D converters and zero crossing detectors are some applications. These units are useful in both battery and line operated systems.

- Operating Temperature Range: -40 to 85°C
- Power Supply - Single 3.0 to 15 V
Dual ±1.5 to ±7.5 V
- Wide Input Voltage Range
- Common Mode Range 0.0 to V_{DD} - 2.0 V for Single Supply
- Externally Programmable Power Consumption with One or Two Resistors
- Internally Compensated Operational Amplifiers
- High Input Impedance
- Comparators - JEDEC B-Series Compatible
- Chip Complexities: MC14573 - 30 FETs
MC14574 - 46 FETs
MC14575 - 38 FETs

**MC14573
 MC14574
 MC14575**

CMOS MSI

**QUAD PROGRAMMABLE
 OPERATIONAL AMPLIFIER
 QUAD PROGRAMMABLE
 COMPARATOR
 PROGRAMMABLE DUAL OP AMP/
 DUAL COMPARATOR**

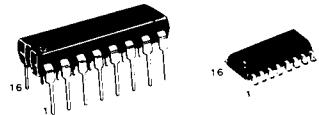

P SUFFIX
 PLASTIC DIP
 CASE 648

D SUFFIX
 SOG
 CASE 751B

ORDERING INFORMATION

MC1457xP
 MC1457xD

Plastic DIP
 SOG Package

PIN ASSIGNMENT

MC14573
 Quad Op Amplifier

MC14574
 Quad Comparator

MC14575
 Dual Op Amplifier (A & B) plus
 Dual Comparator (C & D)

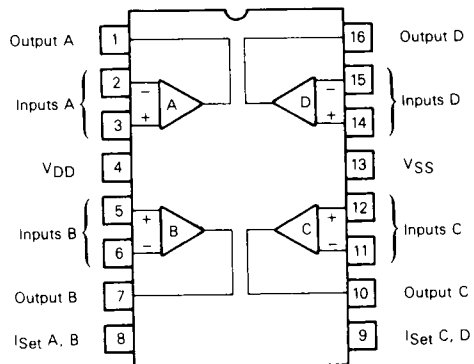

MAXIMUM RATINGS† (Voltages referenced to V_{SS})

Rating	Symbol	Value	Unit
DC Supply Voltage	V _{DD}	-0.5 to +18	V
Input Voltage, All Inputs	V _{in}	-0.5 to V _{DD} + 0.5	V
DC Input Current, per Pin	I _{in}	±10	mA
Programming Current Range	I _{Set}	2	mA
Operating Temperature Range	T _A	-40 to +85	°C
Storage Temperature Range	T _{stg}	-65 to +150	°C
Package Power Dissipation*	P _D	800	mW

This device contains circuitry to protect the inputs against damage due to high static voltages or electric fields, however, it is advised that normal precautions be taken to avoid application of any voltage higher than maximum rated voltages to this high impedance circuit. For proper operation it is recommended that V_{in} and V_{out} be constrained to the range V_{SS} ≤ (V_{in} or V_{out}) ≤ V_{DD}

*Derate above 25°C @ 4.6 mW/°C

†Maximum Ratings are those values beyond which damage to the device may occur.

RECOMMENDED OPERATING RANGE

Rating	Symbol	Value	Unit
DC Supply Voltage	V _{DD} to V _{SS}	+3.0 to +15	V
Programming Current	I _{Set}	2 to 50 2 to 750	μA

V_{DD} = 3V
5V < V_{DD} < 15V

OPERATIONAL AMPLIFIER ELECTRICAL CHARACTERISTICS

(I_{Set} = 20 μA, R_L = 10 MΩ, C_L = 15 pF, T_A = 25°C, unless otherwise indicated, Voltages Referenced to V_{SS})

Characteristic	Symbol	V _{DD} V	Min	Typ#	Max	Unit
Input Common Mode Voltage Range	V _{ICR}	3	0	—	1.5	V
		5	0	—	3.5	
		10	0	—	8.5	
		15	0	—	13.5	
Output Voltage Range R _L = 1 MΩ to V _{SS}	V _{OR}	3	0.05	—	2.95	V
		5	0.05	—	4.95	
		10	0.05	—	9.95	
		15	0.05	—	14.90	
Input Offset Voltage MC14573, MC14575	V _{IO}	3	—	±5	±30	mV
		5	—	±8	±30	
		10	—	±10	±30	
		15	—	±10	±30	
Average Temperature Coefficient of V _{IO}	ΔV _{IO} /ΔT	—	—	15	—	μV/°C
Input Capacitance	C _{in}	—	—	5	10	pF
Input Bias Current	I _{IB}	—	—	1	50	pA
Input Bias Current	I _{IB}	—	—	—	1	nA
Input Offset Current	I _{IO}	—	—	—	100	pA
Open Loop Voltage Gain V _O = 1 V p-p V _O = 3 V p-p V _O = 6 V p-p V _O = 9 V p-p	A _{VOL}	3	2	8	—	V/mV
		5	5	10	—	
		10	8	12	—	
		15	8	12	—	
Power Supply Rejection Ratio MC14573, MC14575	PSRR	3	45	57	—	dB
		5	54	67	—	
		10	54	67	—	
		15	54	67	—	
Common Mode Rejection Ratio MC14573, MC14575	CMRR	3	45	70	—	dB
		5	50	73	—	
		10	54	75	—	
		15	54	75	—	
Output Source Current V _{OH} = V _{DD} - 0.6 V	I _{OH}	5	55	80	—	μA
Output Sink Current V _{in+} = V _{DD} /2 + 0.5 V _{in-} = V _{DD} /2 - 0.5 V _{OL} = 0.4 V V _{OL} = 0.4 V V _{OL} = 0.5 V V _{OL} = 1.5 V	I _{OL}	3	2.1	4.2	—	mA
		5	2.5	5.0	—	
		10	5.5	11.0	—	
		15	15	30	—	
Slew Rate	S _R	—	0.6	0.8	—	V/μs
Unity Gain Bandwidth	GBW	5	0.5	1	—	MHz
Phase Margin	φ _M	—	—	45	—	Degrees
Channel Separation	—	—	—	80	—	dB
Supply Current, Per Pair R _L = ∞, I _{Set} = 20 μA, V _{in+} = 1.0 V, V _{in-} = 0 V (R _L = ∞, Pins 8 and 9 = V _{DD})	I _{DD}	5	—	260	340	μA
		15	—	0.05	1.0	

#Data labelled "Typ" is not to be used for design purposes but is intended as an indication of the IC's potential performance.



MC14573•MC14574•MC14575

OPERATIONAL AMPLIFIER ELECTRICAL CHARACTERISTICS

($I_{Set} = 200 \mu A$, $R_L = 10 M\Omega$, $C_L = 15 pF$, $T_A = 25^\circ C$, unless otherwise indicated, Voltages Referenced to V_{SS})

Characteristic	Symbol	V_{DD} V	Min	Typ#	Max	Unit
Input Common Mode Voltage Range	V_{ICR}	5 10 15	0 0 0	— — —	3 8 13	V
Output Voltage Range $R_L = 100 k$ to V_{SS}	V_{OR}	5 10 15	0.1 0.1 0.1	— — —	4.8 9.8 14.8	V
Input Offset Voltage MC14573, MC14575	V_{IO}	5 10 15	— — —	± 8 ± 10 ± 12	± 30 ± 30 ± 30	mV
Average Temperature Coefficient of V_{IO}	$\Delta V_{IO}/\Delta T$	—	—	20	—	$\mu V/^\circ C$
Input Capacitance	C_{in}	—	—	5	10	pF
Input Bias Current	I_{IB}	—	—	1	50	pA
Input Bias Current $T_A = -40^\circ C$ to $+85^\circ C$	I_{IB}	—	—	—	1	nA
Input Offset Current	I_{IO}	—	—	—	100	pA
Open Loop Voltage Gain $V_O = 3 V$ p-p $V_O = 6 V$ p-p $V_O = 9 V$ p-p	AV_{OL}	5 10 15	1 1 1	2 3 4	— — —	V/mV
Power Supply Rejection Ratio MC14573, MC14575	PSRR	5 10 15	45 54 54	54 67 67	— — —	dB
Common Mode Rejection Ratio MC14573, MC14575	CMRR	5 10 15	40 50 50	55 67 70	— — —	dB
Output Source Current $V_{OH} = V_{DD} - 1.5 V$	I_{OH}	15	550	800	—	μA
Output Sink Current $V_{OL} = 0.4 V$ $V_{OL} = 0.5 V$ $V_{OL} = 1.5 V$	I_{OL}	5 10 15	2.2 5.0 15	4.2 10.0 30	— — —	mA
Slew Rate	S_R	—	5	7	—	V/ μs
Unity Gain Bandwidth	GBW	5	1.5	3	—	MHz
Phase Margin	ϕ_M	—	—	48	—	Degrees
Channel Separation	—	—	—	80	—	dB
Supply Current, Per Pair ($R_L = \infty$, $V_{in+} = 1.0 V$, $V_{in-} = 0 V$)	I_{DD}	15	—	2.6	3.4	mA

#Data labelled "Typ" is not to be used for design purposes but is intended as an indication of the IC's potential performance.

COMPARATOR ELECTRICAL CHARACTERISTICS

(I_{Set} = 20 μA, R_L = 10 MΩ, C_L = 50 pF, T_A = 25°C, unless otherwise indicated, Voltages Referenced to V_{SS})

Characteristic	Symbol	V _{DD} V	Min	Typ #	Max	Unit
Input Common Mode Voltage Range	V _{ICR}	3	0	—	1.5	V
		5	0	—	3.5	
		10	0	—	8.5	
		15	0	—	13.5	
Output Voltage Range "0" Level	V _{OL}	3	—	0	0.05	V
		5	—	0	0.05	
		10	—	0	0.05	
		15	—	0	0.05	
Output Voltage Range "1" Level	V _{OH}	3	2.95	3	—	V
		5	4.95	5	—	
		10	9.95	10	—	
		15	14.95	15	—	
Input Offset Voltage MC14574, MC14575	V _{IO}	3	—	±8	±30	mV
		5	—	±8	±30	
		10	—	±10	±30	
		15	—	±10	±30	
Average Temperature Coefficient of V _{IO}	ΔV _{IO} /ΔT	—	—	15	—	μV/°C
Input Capacitance	C _{in}	—	—	5	10	pF
Input Bias Current	I _{IB}	—	—	1	50	pA
Input Bias Current T _A = -40°C to +85°C	I _{IB}	—	—	—	1	nA
Input Offset Current	I _{IO}	—	—	—	100	pA
Open Loop Voltage Gain V _O = 1 Vp-p V _O = 3 Vp-p V _O = 6 Vp-p V _O = 9 Vp-p	A _{VOL}	3	1	20	—	V/mV
		5	1	10	—	
		10	1	6	—	
		15	1	6	—	
Power Supply Rejection Ratio MC14574, MC14575	PSRR	3	45	57	—	dB
		5	54	67	—	
		10	54	67	—	
		15	54	67	—	
Common Mode Rejection Ratio MC14574, MC14575	CMRR	3	45	55	—	dB
		5	50	65	—	
		10	54	67	—	
		15	54	67	—	
Output Source Current V _{OH} = 2.6 V V _{OH} = 2.5 V V _{OH} = 4.6 V V _{OH} = 9.5 V V _{OH} = 13.5 V	I _{OH}	3	-0.35	-0.65	—	mA
		5	-2.5	-5.0	—	
		5	-0.60	-1.1	—	
		10	-1.3	-2.5	—	
		15	-5.0	-9.5	—	
Output Sink Current V _{OL} = 0.4 V V _{OL} = 0.4 V V _{OL} = 0.5 V V _{OL} = 1.5 V	I _{OL}	3	1.3	2.6	—	mA
		5	1.9	3.8	—	
		10	3.5	6.5	—	
		15	14	25	—	
Output Rise and Fall Time, 100 mV Overdrive	t _{TLH} , t _{THL}	3	—	140	250	ns
		5	—	100	180	
		10	—	120	200	
		15	—	140	250	
Propagation Delay Time, 5 mV Overdrive	t _d	3	—	15	30	μs
		5	—	10	20	
		10	—	12	24	
		15	—	15	30	
Propagation Delay Time, 100 mV Overdrive	t _d	3	—	4	8	μs
		5	—	2	4	
		10	—	3	6	
		15	—	4	8	
Channel Separation	—	—	—	80	—	dB
Supply Current, Per Pair (R _L = ∞, I _{Set} = 20 μA, V _{In+} = 1.0 V, V _{In-} = 0 V)	I _{DD}	5	—	180	250	μA

#Data labelled "Typ" is not to be used for design purposes but is intended as an indication of the IC's potential performance.

COMPARATOR ELECTRICAL CHARACTERISTICS

(I_{Set} = 200 μA, R_L = 10 MΩ, C_L = 50 pF, T_A = 25°C, unless otherwise indicated, Voltages Referenced to V_{SS})

Characteristic	Symbol	V _{DD} V	Min	Typ#	Max	Unit	
Input Common Mode Voltage Range	V _{ICR}	5 10 15	0 0 0	— — —	3 8 13	V	
Output Voltage Range "0" Level	V _{OL}	5 10 15	— — —	0 0 0	0.05 0.05 0.05	V	
Output Voltage Range "1" Level	V _{OH}	5 10 15	4.95 9.95 14.95	5 10 15	— — —	V	
Input Offset Voltage MC14574, MC14575	V _{IO}	5 10 15	— — —	±10 ±13 ±15	±30 ±30 ±30	mV	
Average Temperature Coefficient of V _{IO}	T _A = -40°C to +85°C	ΔV _{IO} /ΔT	—	—	20	—	μV/°C
Input Capacitance	C _{in}	—	—	5	10	—	pF
Input Bias Current	I _{IB}	—	—	1	50	—	pA
Input Bias Current	T _A = -40°C to +85°C	I _{IB}	—	—	1	—	nA
Input Offset Current	I _{IO}	—	—	—	100	—	pA
Open Loop Voltage Gain	V _O = 3 Vp-p V _O = 6 Vp-p V _O = 9 Vp-p	A _{VOL}	5 10 15	2 1 1	7 4 4	— — —	V/mV
Power Supply Rejection Ratio MC14574, MC14575	PSRR	5 10 15	45 54 54	67 67 67	— — —	—	dB
Common Mode Rejection Ratio MC14574, MC14575	CMRR	5 10 15	40 50 50	65 67 67	— — —	—	dB
Output Source Current	V _{OH} = 2.5 V V _{OH} = 4.6 V V _{OH} = 9.5 V V _{OH} = 13.5 V	I _{OH}	5 5 10 15	-2.5 -0.60 -1.3 -5.0	-5.0 -1.1 -2.5 -9.5	— — — —	mA
Output Sink Current	V _{OL} = 0.4 V V _{OL} = 0.5 V V _{OL} = 1.5 V	I _{OL}	5 10 15	1.9 3.5 14	3.8 6.5 25	— — —	mA
Output Rise and Fall Time, 100 mV Overdrive	t _{TLH} t _{THL}	5 10 15	— — —	75 50 45	150 100 90	—	ns
Propagation Delay Time, 5 mV Overdrive	t _d	5 10 15	— — —	2.5 3.5 5	5.0 7 10	—	μs
Propagation Delay Time, 100 mV Overdrive	t _d	5 10 15	— — —	0.6 0.75 0.75	1.2 1.5 1.5	—	μs
Channel Separation	—	—	—	80	—	—	dB
Supply Current, Per Pair (R _L = ∞, V _{in+} = 1.0 V, V _{in-} = 0 V)	I _{DD}	15	—	1.8	2.5	—	mA

#Data labelled "Typ" is not to be used for design purposes but is intended as an indication of the IC's potential performance.

The programming current I_{Set} is fixed by an external resistor R_{Set} connected between V_{SS} and either one or both of the I_{Set} pins (8 and 9). When two external programming resistors are used, the set currents for each op amp pair or comparator are given by:

$$I_{Set} (\mu A) \approx \frac{V_{DD} - V_{SS} - 1.5}{R_{Set} (M\Omega)}$$

Pins 8 and 9 may be tied together for use with a single programming resistor. The set currents for each op amp pair or comparator pair are then given by:

$$I_{Set A, B} = I_{Set C, D} (\mu A) \approx \frac{V_{DD} - V_{SS} - 1.5}{2 R_{Set} (M\Omega)}$$

The total device current is typically 13 times I_{Set} per pair if the outputs are in the low state, and 5 times I_{Set} per pair if the outputs are in the high state. For op amps with an output in the linear region the device current will be between the values of 5 times and 13 times I_{Set} .

If a pair of op amps is not used, the I_{Set} pin for that pair may be tied to V_{DD} for minimum power consumption. To minimize power consumption in an unused pair of comparators this is not effective. The comparators should use a high value set resistor and the inputs should be set to a voltage that will force the output to V_{DD} (i.e., $+in = V_{DD}$, $-in = V_{SS}$).

It should be noted that increasing I_{Set} for comparators will decrease propagation delay for that comparator.

For operational amplifiers, the maximum obtainable output voltage (V_{OH}) for a given load resistor connected to V_{SS} is given by:

$$V_{OH} = 4 \times I_{Set} \times R_L - 0.05 \text{ V, } R_L \text{ in } \Omega, I_{Set} \text{ in } \mu A$$

Note: $V_{OH} \text{ Max} = V_{DD}$

Typical op amp slew rates are given by:

$$S_R \approx 0.04 I_{Set} (\text{V}/\mu\text{s}), I_{Set} \text{ in } \mu A$$

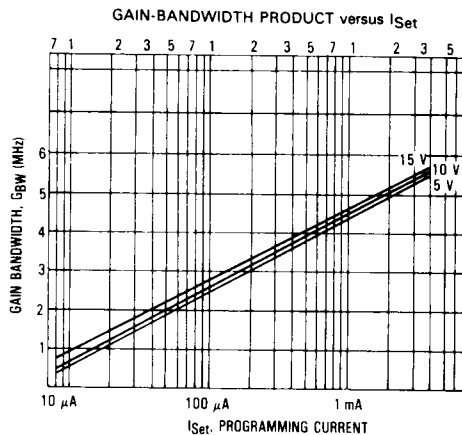
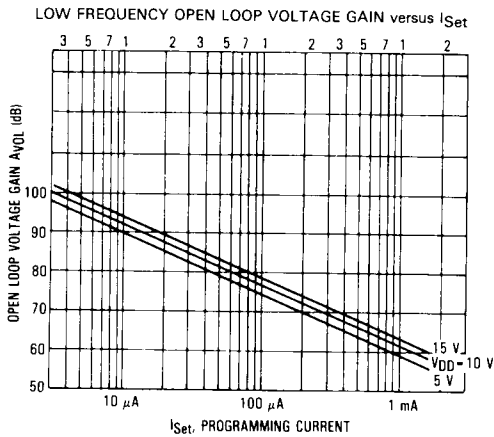
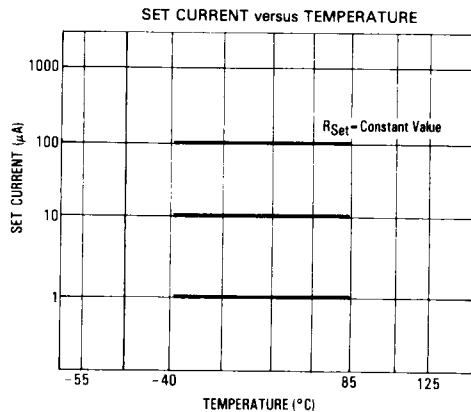
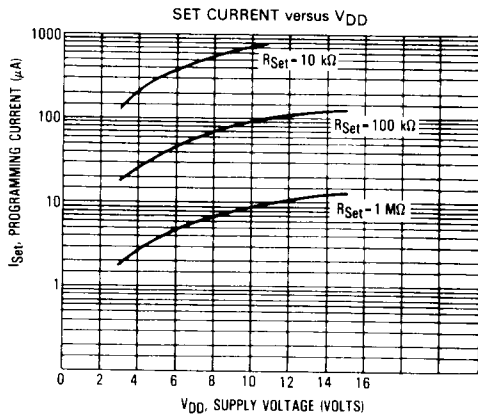

4

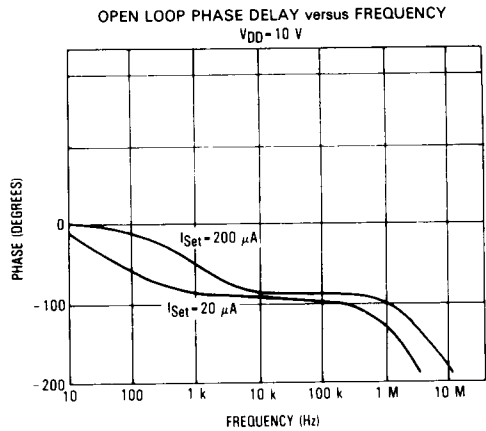
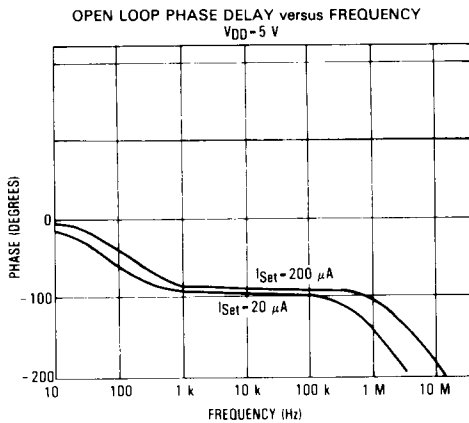
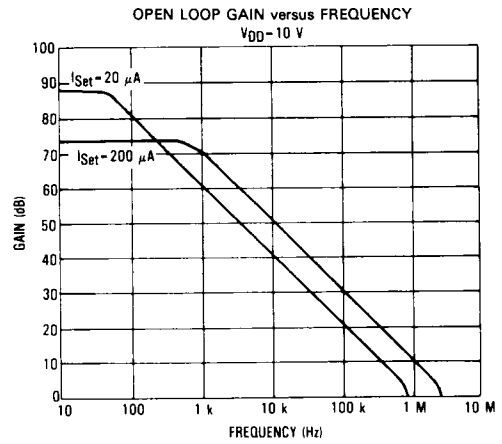
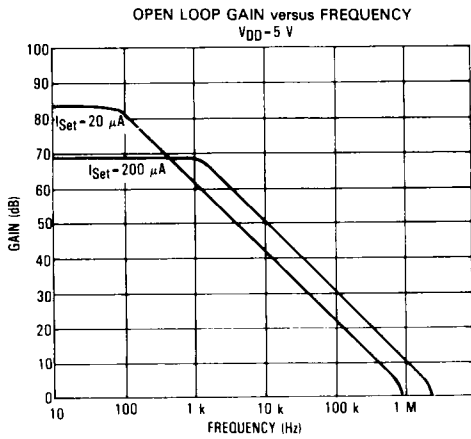
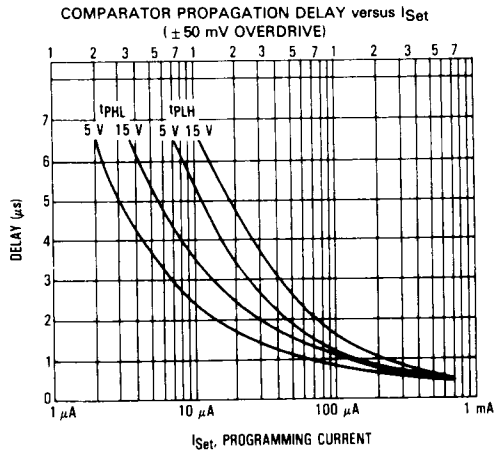
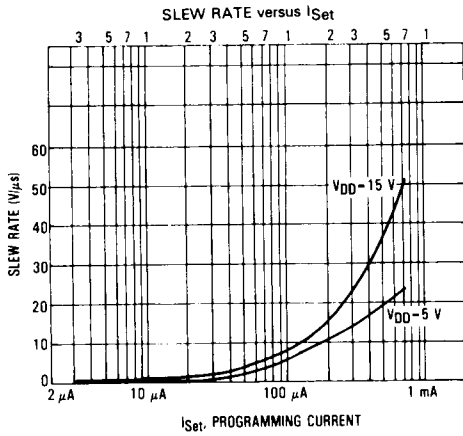

SMALL SIGNAL TRANSIENT RESPONSE
 $V_{DD} = 10\text{ V}$ NON-INVERTING UNITY GAIN
 $I_{Set} = 200\ \mu\text{A}$, V_{in} AVERAGE = 5 V

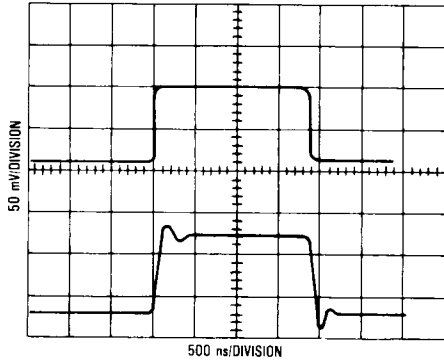

LARGE SIGNAL TRANSIENT RESPONSE
 $V_{DD} = 10\text{ V}$ NON-INVERTING UNITY GAIN
 $I_{Set} = 200\ \mu\text{A}$, V_{in} AVERAGE = 5 V

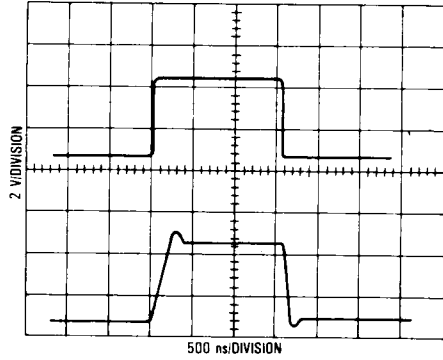

SMALL SIGNAL TRANSIENT RESPONSE
 $V_{DD} = 10\text{ V}$ NON-INVERTING UNITY GAIN
 $I_{Set} = 20\ \mu\text{A}$, V_{in} AVERAGE = 5 V

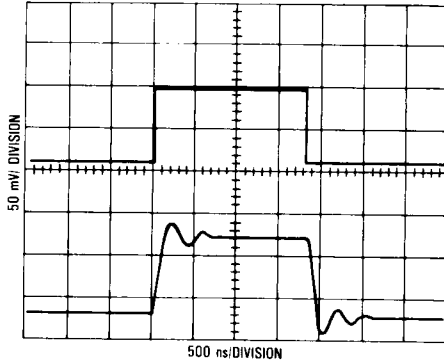

LARGE SIGNAL TRANSIENT RESPONSE
 $V_{DD} = 10\text{ V}$ NON-INVERTING UNITY GAIN
 $I_{Set} = 20\ \mu\text{A}$, V_{in} AVERAGE = 5 V

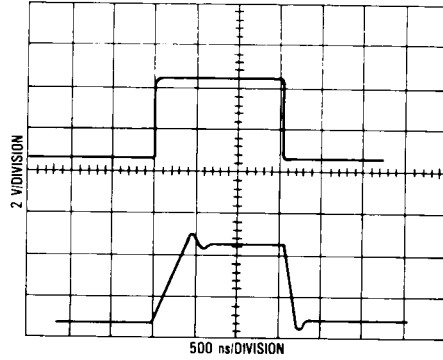

EQUIVALENT INPUT NOISE VOLTAGE (E_N) versus FREQUENCY

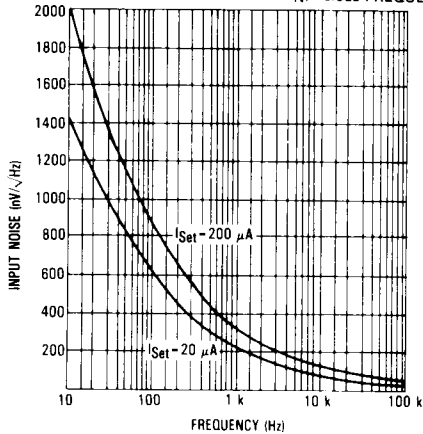

TYPICAL INPUT LEAKAGE versus TEMPERATURE
 $V_{DD} = 15\text{ V}$, $V_{in} = 7.5\text{ V}$

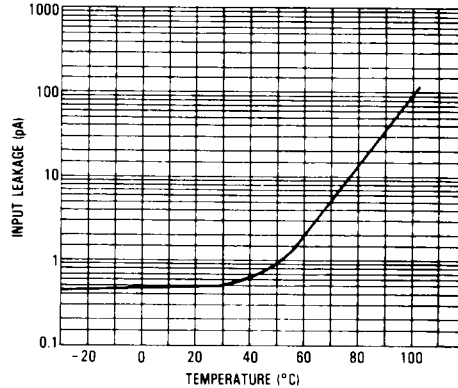

COMPARATOR PROPAGATION DELAY versus OVERDRIVE*
 $V_{DD} = 10\text{ V}$, t_{PLH} and t_{PHL}

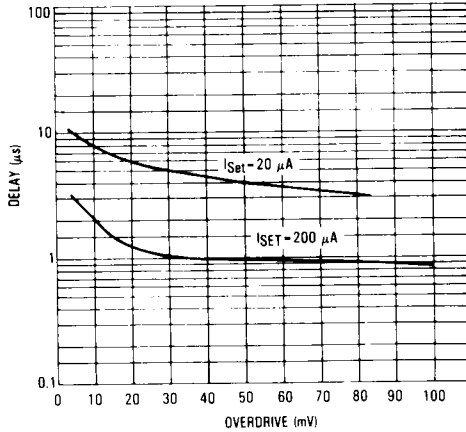

* A 10 mV overdrive is a signal on one input of a comparator that ranges from 10 mV less than the other input to 10 mV more than the other input.

4

OPERATIONAL AMPLIFIER SCHEMATIC
 1/4th CIRCUIT

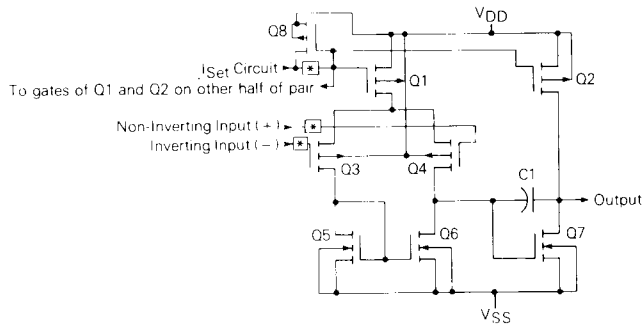

COMPARATOR SCHEMATIC
 1/4th CIRCUIT

