

# MURA130, SURA8130, MURA140, NRVUA140V, SURA8140

## Surface Mount Ultrafast Power Rectifiers

Ideally suited for high voltage, high frequency rectification, or as free wheeling and protection diodes in surface mount applications where compact size and weight are critical to the system.

### Features

- Small Compact Surface Mountable Package with J-Bend Leads
- Rectangular Package for Automated Handling
- High Temperature Glass Passivated Junction
- Low Forward Voltage Drop (0.89 V Max @ 1.0 A,  $T_J = 150^\circ\text{C}$ )
- NRVUA and SURA8 Prefixes for Automotive and Other Applications Requiring Unique Site and Control Change Requirements; AEC-Q101 Qualified and PPAP Capable\*
- These Devices are Pb-Free, Halogen Free/BFR Free and are RoHS Compliant

### Mechanical Characteristics:

- Case: Epoxy, Molded
- Weight: 70 mg (Approximately)
- Finish: All External Surfaces Corrosion Resistant and Terminal Leads are Readily Solderable
- Lead and Mounting Surface Temperature for Soldering Purposes:  $260^\circ\text{C}$  Max. for 10 Seconds
- Polarity: Polarity Band Indicates Cathode Lead
- ESD Protection:
  - ◆ Human Body Model > 4000 V (Class 3)
  - ◆ Machine Model > 400 V (Class C)



ON Semiconductor®

[www.onsemi.com](http://www.onsemi.com)

## ULTRAFAST RECTIFIERS 1 AMPERE, 300–400 VOLTS



SMA  
CASE 403D

### MARKING DIAGRAM

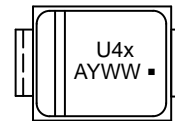

U4x = Device Code  
 x = F for MURA130  
    = G for MURA140  
 A = Assembly Location\*\*  
 Y = Year  
 WW = Work Week  
 ■ = Pb-Free Package

\*\* The Assembly Location Code (A) is front side optional. In cases where the Assembly Location is stamped in the package bottom (molding ejecter pin), the front side assembly code may be blank.

### ORDERING INFORMATION

Device	Package	Shipping†
MURA130T3G	SMA (Pb-Free)	5,000/Tape & Reel
SURA8130T3G*	SMA (Pb-Free)	5,000/Tape & Reel
MURA140T3G	SMA (Pb-Free)	5,000/Tape & Reel
NRVUA140VT3G*	SMA (Pb-Free)	5,000/Tape & Reel
SURA8140T3G*	SMA (Pb-Free)	5,000/Tape & Reel

†For information on tape and reel specifications, including part orientation and tape sizes, please refer to our Tape and Reel Packaging Specifications Brochure, BRD8011/D.

# MURA130, SURA8130, MURA140, NRVUA140V, SURA8140

## MAXIMUM RATINGS

Rating	Symbol	Value	Unit
Peak Repetitive Reverse Voltage Working Peak Reverse Voltage DC Blocking Voltage MURA130T3G/SURA8130T3G MURA140T3G/SURA8140T3G/NRVUA140VT3G/SURA8130T3G-VF01	$V_{RRM}$ $V_{RWM}$ $V_R$	300 400	V
Average Rectified Forward Current @ $T_L = 150^\circ\text{C}$ @ $T_L = 125^\circ\text{C}$	$I_{F(AV)}$	1.0 2.0	A
Non-Repetitive Peak Surge Current (Surge Applied at Rated Load Conditions Halfwave, Single Phase, 60 Hz)	$I_{FSM}$	35	A
Operating Junction Temperature Range	$T_J$	-65 to +175	$^\circ\text{C}$

Stresses exceeding those listed in the Maximum Ratings table may damage the device. If any of these limits are exceeded, device functionality should not be assumed, damage may occur and reliability may be affected.

## THERMAL CHARACTERISTICS

Characteristic	Symbol	Max	Unit
Thermal Resistance, Junction-to-Lead ( $T_L = 25^\circ\text{C}$ ) (Note 1)	$\Psi_{sJL}$ (Note 2)	24	$^\circ\text{C/W}$
Thermal Resistance, Junction-to-Ambient (Note 1)	$R_{\theta JA}$	216	

- Rating applies when surface mounted on the minimum pad size recommended, PC Board FR-4.
- In compliance with JEDEC 51, these values (historically represented by  $R_{\theta JL}$ ) are now referenced as  $\Psi_{sJL}$ .

## ELECTRICAL CHARACTERISTICS

Characteristic	Symbol	Max	Unit
Maximum Instantaneous Forward Voltage (Note 3) ( $i_F = 1.0\text{ A}$ , $T_J = 25^\circ\text{C}$ ) ( $i_F = 1.0\text{ A}$ , $T_J = 150^\circ\text{C}$ )	$V_F$	1.1 0.89	V
Maximum Instantaneous Reverse Current (Note 3) (Rated DC Voltage, $T_J = 25^\circ\text{C}$ ) (Rated DC Voltage, $T_J = 150^\circ\text{C}$ )	$i_R$	5.0 150	$\mu\text{A}$
Maximum Reverse Recovery Time ( $i_F = 1.0\text{ A}$ , $di/dt = 50\text{ A}/\mu\text{s}$ )	$t_{rr}$	65	ns

Product parametric performance is indicated in the Electrical Characteristics for the listed test conditions, unless otherwise noted. Product performance may not be indicated by the Electrical Characteristics if operated under different conditions.

- Pulse Test: Pulse Width = 300  $\mu\text{s}$ , Duty Cycle  $\leq 2.0\%$ .

MURA130, SURA8130, MURA140, NRVUA140V, SURA8140

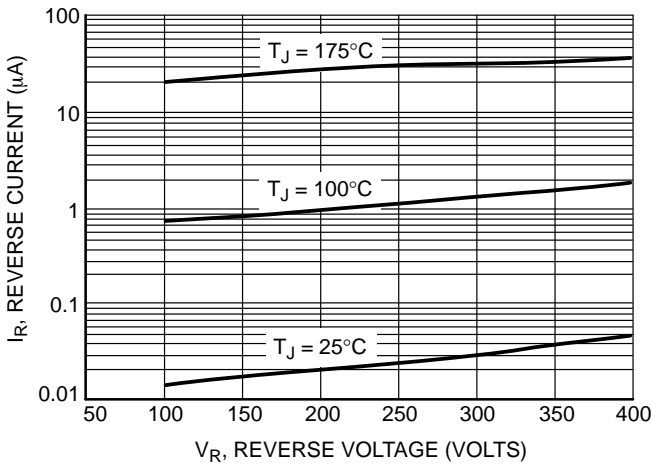

Figure 1. Typical Reverse Current

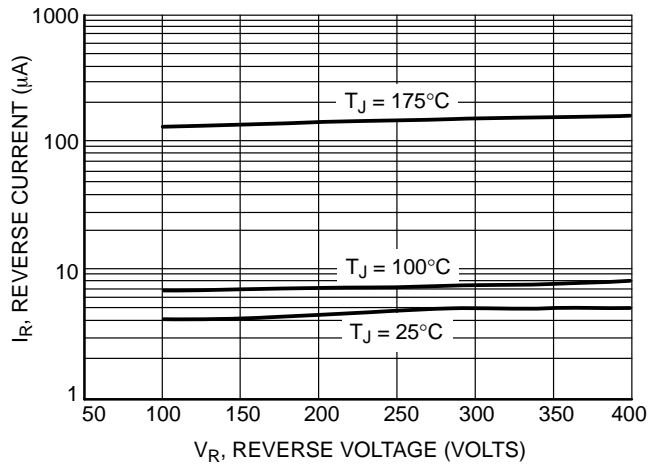

Figure 2. Maximum Reverse Current

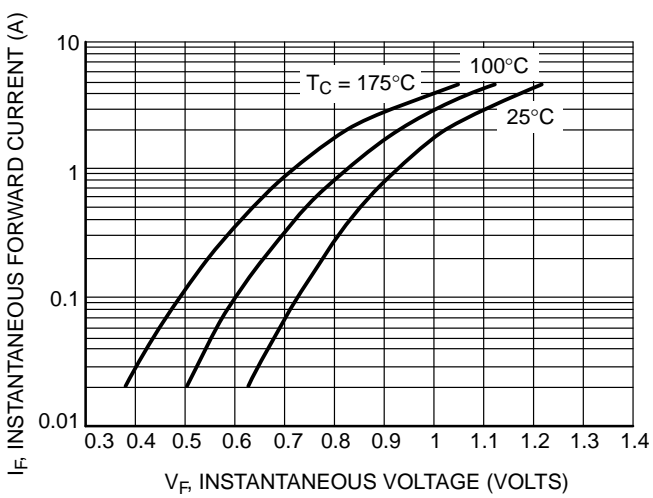

Figure 3. Typical Forward Voltage

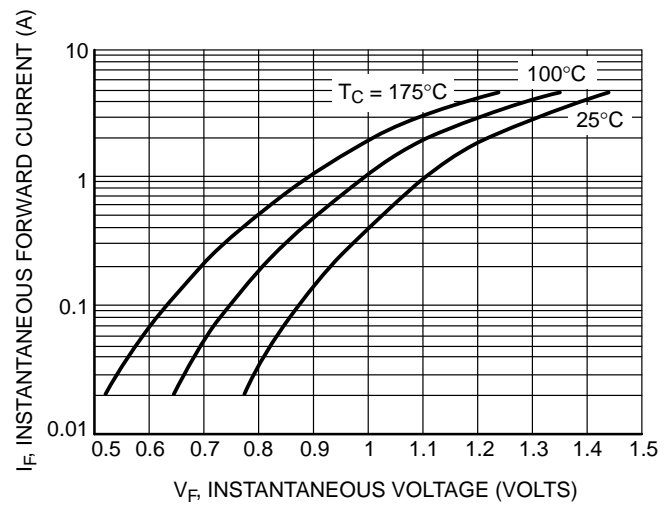

Figure 4. Maximum Forward Voltage

MURA130, SURA8130, MURA140, NRVUA140V, SURA8140

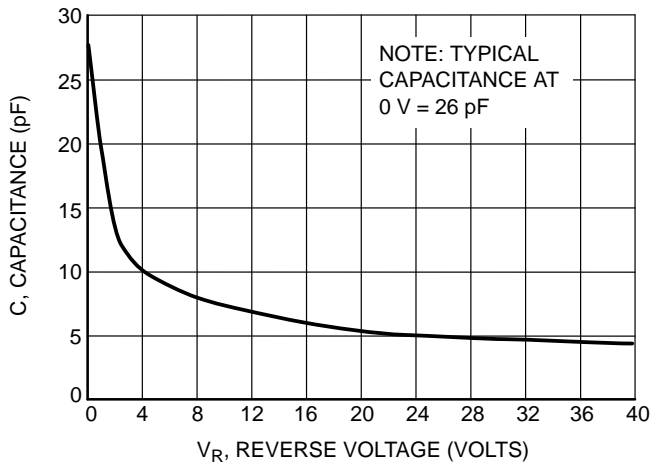

Figure 5. Typical Capacitance

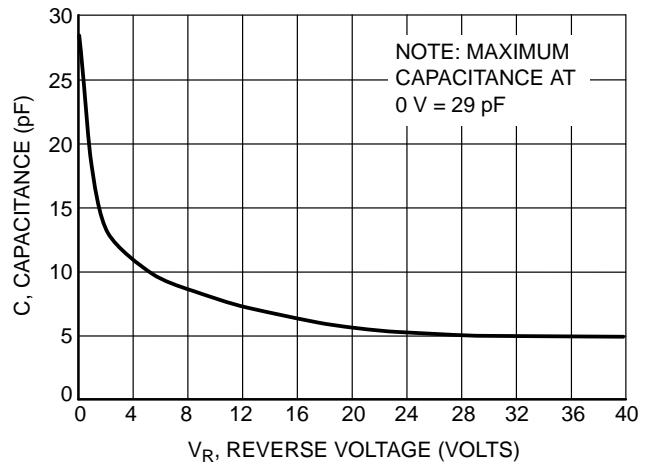

Figure 6. Maximum Capacitance

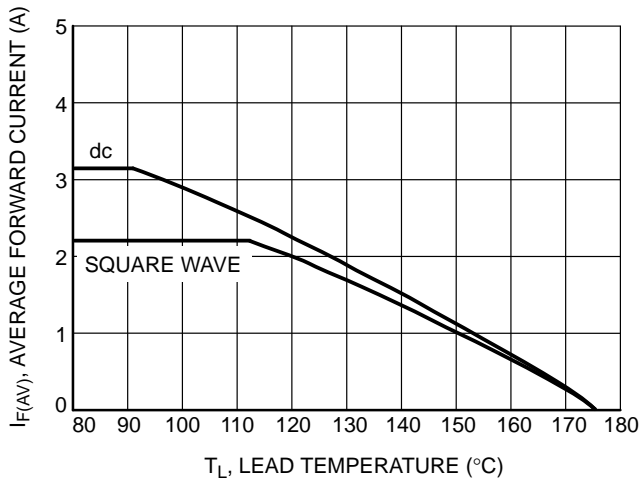

Figure 7. Current Derating, Lead

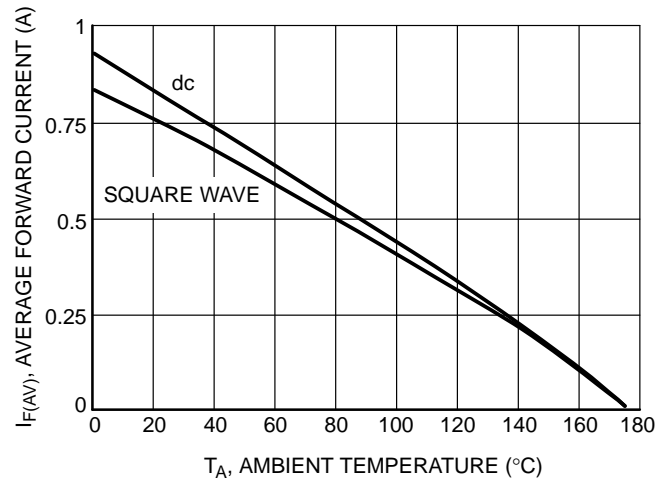

Figure 8. Current Derating, Ambient (FR-4 Board with Minimum Pad)

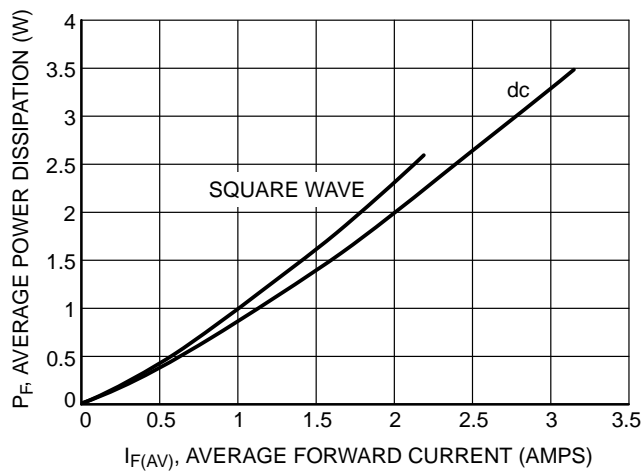
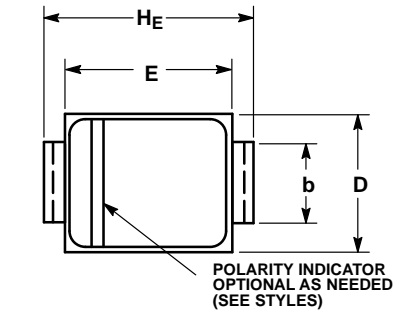

Figure 9. Power Dissipation

# MURA130, SURA8130, MURA140, NRVUA140V, SURA8140

## PACKAGE DIMENSIONS

### SMA CASE 403D ISSUE H



- NOTES:
1. DIMENSIONING AND TOLERANCING PER ANSI Y14.5M, 1982.
  2. CONTROLLING DIMENSION: INCH.
  3. DIMENSION b SHALL BE MEASURED WITHIN DIMENSION L.

DIM	MILLIMETERS			INCHES		
	MIN	NOM	MAX	MIN	NOM	MAX
A	1.97	2.10	2.20	0.078	0.083	0.087
A1	0.05	0.10	0.20	0.002	0.004	0.008
b	1.27	1.45	1.63	0.050	0.057	0.064
c	0.15	0.28	0.41	0.006	0.011	0.016
D	2.29	2.60	2.92	0.090	0.103	0.115
E	4.06	4.32	4.57	0.160	0.170	0.180
HE	4.83	5.21	5.59	0.190	0.205	0.220
L	0.76	1.14	1.52	0.030	0.045	0.060

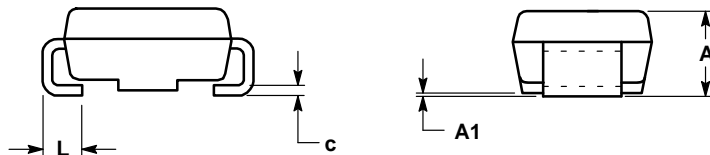

- STYLE 1:  
PIN 1. CATHODE (POLARITY BAND)  
2. ANODE

### SOLDERING FOOTPRINT\*

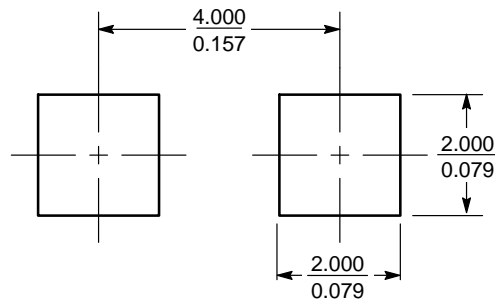

SCALE 8:1  $\left(\frac{\text{mm}}{\text{inches}}\right)$

\*For additional information on our Pb-Free strategy and soldering details, please download the ON Semiconductor Soldering and Mounting Techniques Reference Manual, SOLDERRM/D.

ON Semiconductor and are trademarks of Semiconductor Components Industries, LLC dba ON Semiconductor or its subsidiaries in the United States and/or other countries. ON Semiconductor owns the rights to a number of patents, trademarks, copyrights, trade secrets, and other intellectual property. A listing of ON Semiconductor's product/patent coverage may be accessed at [www.onsemi.com/site/pdf/Patent-Marking.pdf](http://www.onsemi.com/site/pdf/Patent-Marking.pdf). ON Semiconductor reserves the right to make changes without further notice to any products herein. ON Semiconductor makes no warranty, representation or guarantee regarding the suitability of its products for any particular purpose, nor does ON Semiconductor assume any liability arising out of the application or use of any product or circuit, and specifically disclaims any and all liability, including without limitation special, consequential or incidental damages. Buyer is responsible for its products and applications using ON Semiconductor products, including compliance with all laws, regulations and safety requirements or standards, regardless of any support or applications information provided by ON Semiconductor. "Typical" parameters which may be provided in ON Semiconductor data sheets and/or specifications can and do vary in different applications and actual performance may vary over time. All operating parameters, including "Typicals" must be validated for each customer application by customer's technical experts. ON Semiconductor does not convey any license under its patent rights nor the rights of others. ON Semiconductor products are not designed, intended, or authorized for use as a critical component in life support systems or any FDA Class 3 medical devices or medical devices with a same or similar classification in a foreign jurisdiction or any devices intended for implantation in the human body. Should Buyer purchase or use ON Semiconductor products for any such unintended or unauthorized application, Buyer shall indemnify and hold ON Semiconductor and its officers, employees, subsidiaries, affiliates, and distributors harmless against all claims, costs, damages, and expenses, and reasonable attorney fees arising out of, directly or indirectly, any claim of personal injury or death associated with such unintended or unauthorized use, even if such claim alleges that ON Semiconductor was negligent regarding the design or manufacture of the part. ON Semiconductor is an Equal Opportunity/Affirmative Action Employer. This literature is subject to all applicable copyright laws and is not for resale in any manner.

### PUBLICATION ORDERING INFORMATION

**LITERATURE FULFILLMENT:**  
Literature Distribution Center for ON Semiconductor  
19521 E. 32nd Pkwy, Aurora, Colorado 80011 USA  
**Phone:** 303-675-2175 or 800-344-3860 Toll Free USA/Canada  
**Fax:** 303-675-2176 or 800-344-3867 Toll Free USA/Canada  
**Email:** [orderlit@onsemi.com](mailto:orderlit@onsemi.com)

**N. American Technical Support:** 800-282-9855 Toll Free  
USA/Canada  
**Europe, Middle East and Africa Technical Support:**  
Phone: 421 33 790 2910  
**Japan Customer Focus Center**  
Phone: 81-3-5817-1050

**ON Semiconductor Website:** [www.onsemi.com](http://www.onsemi.com)  
**Order Literature:** <http://www.onsemi.com/orderlit>

For additional information, please contact your local Sales Representative