

Mini TOPLED® RG

LS M770, LO M770, LY M770, LG M770, LP M770

Abgekündigt nach PD_078_02 - werden durch Mini TOPLED Santana® ersetzt werden
Obsolete acc. to PD_078_02 - will be replaced by Mini TOPLED Santana®



Besondere Merkmale

- **Gehäusetyp:** weißes SMT-Gehäuse, farbloser klarer Verguss
- **Besonderheit des Bauteils:** extrem breite Abstrahlcharakteristik; Bauteil wird top-down montiert und strahlt durch das PCB; ideal für Hinterleuchtungen und Einkopplungen in Lichtleiter
- **Wellenlänge:** 628 nm (super-rot), 606 nm (orange), 587 nm (gelb), 570 nm (grün), 560 nm (pure green)
- **Abstrahlwinkel:** Lambertscher Strahler (120°)
- **Technologie:** GaAsP (super-rot, orange, gelb, grün), GaP (pure green)
- **optischer Wirkungsgrad:** 1,5 lm/W (super-rot, orange, gelb), 2,5 lm/W (grün), 0,6 lm/W (pure green)
- **Gruppierungsparameter:** Lichtstärke, Wellenlänge
- **Verarbeitungsmethode:** für alle SMT-Bestücktechniken geeignet
- **Lötmethode:** IR Reflow Löten
- **Vorbehandlung:** nach JEDEC Level 2
- **Gurtung:** 12-mm Gurt mit 3000/Rolle, ø180 mm oder 11800/Rolle, ø330 mm

Anwendungen

- optischer Indikator
- Einkopplung in Lichtleiter
- Hinterleuchtung (LCD, Handy, Schalter, Tasten, Displays, Werbebeleuchtung, Allgemeinbeleuchtung)
- Innenbeleuchtung im Automobilbereich (z.B. Instrumentenbeleuchtung, u.ä.)

Features

- **package:** white SMT package, colorless clear
- **feature of the device:** extremely wide viewing angle; LED is mounted top down and emits through the PCB; ideal for backlighting and coupling in light guides
- **wavelength:** 628 nm (super-red), 606 nm (orange), 587 nm (yellow), 570 nm (green), 560 nm (pure green)
- **viewing angle:** Lambertian Emitter (120°)
- **technology:** GaAsP (super-red, orange, yellow, green), GaP (pure green)
- **optical efficiency:** 1.5 lm/W (super-red, orange, yellow), 2.5 lm/W (green), 0.6 lm/W (pure green)
- **grouping parameter:** luminous intensity, wavelength
- **assembly methods:** suitable for all SMT assembly methods
- **soldering methods:** IR reflow soldering
- **preconditioning:** acc. to JEDEC Level 2
- **taping:** 12 mm tape with 3000/reel, ø180 mm or 11800/reel, ø330 mm

Applications

- optical indicators
- coupling into light guides
- backlighting (LCD, cellular phones, switches, keys, displays, illuminated advertising, general lighting)
- interior automotive lighting (e.g. dashboard backlighting, etc.)

LS M770, LO M770, LY M770, LG M770, LP M770

Typ	Emissions- farbe	Lichtstärke	Lichtstrom	Bestellnummer
Type	Color of Emission	Luminous Intensity $I_F = 10 \text{ mA}$ $I_V \text{ (mcd)}$	Luminous Flux $I_F = 10 \text{ mA}$ $\Phi_V \text{ (lm)}$	Ordering Code
■LS M770-H2J2-1	super-red	3.55 ... 7.10	15 (typ.)	Q62703Q5087
■LS M770-J2L1-1		5.60 ... 14.00	28 (typ.)	Q62703Q5088
■LO M770-H2J2-24	orange	3.55 ... 7.10	15 (typ.)	Q62703Q5042
■LO M770-J2L1-24		5.60 ... 14.00	28 (typ.)	Q62703Q5043
■LY M770-J1K1-26	yellow	4.50 ... 9.00	20 (typ.)	Q62703Q5125
■LY M770-K1L2-26		7.10 ... 18.00	36 (typ.)	Q62703Q5126
■LG M770-J2K2-1	green	5.60 ... 11.20	25 (typ.)	Q62703Q5008
■LG M770-K2M1-1		9.00 ... 22.40	45 (typ.)	Q62703Q5009
■LP M770-F2G2-1	pure green	1.40 ... 2.80	6 (typ.)	Q62703Q5062
■LP M770-G2J1-1		2.24 ... 5.60	11 (typ.)	Q62703Q5063

- Abgekündigt nach PD_078_02 - werden durch Mini TOPLED Santana® ersetzt werden
 Obsolete acc. to PD_078_02 - will be replaced by Mini TOPLED Santana®
 Letzte Bestellung / Last Order: 30.09.2003
 Letzte Lieferung / Last Delivery: 31.03.2004

Anm.: -1 gesamter Farbbereich (siehe **Seite 4**)
 -24 gesamter Farbbereich, Lieferung in Einzelgruppen (siehe **Seite 5**)
 -26 gesamter Farbbereich, Lieferung in Einzelgruppen (siehe **Seite 5**)

*Die Standardlieferform von Serientypen beinhaltet eine untere bzw. eine obere Familiengruppe. Diese besteht aus 3 bzw. 4 Helligkeitshalbgruppen besteht. Einzelne Helligkeitshalbgruppen sind nicht bestellbar.
 In einer Verpackungseinheit / Gurt ist immer nur eine Helligkeitshalbgruppe enthalten.*

Note: -1 Total color tolerance range (please see **page 4**)
 -24 Total color tolerance range, delivery in single groups (please see **page 5**)
 -26 Total color tolerance range, delivery in single groups (please see **page 5**)

*The standard shipping format for serial types includes a lower or upper family group of 3 or 4 individual luminous intensity half groups. Individual luminous intensity half groups cannot be ordered.
 No packing unit / tape ever contains more than one luminous intensity half group.*

Grenzwerte
Maximum Ratings

Bezeichnung Parameter	Symbol Symbol	Wert Value		Einheit Unit
		LS, LO, LY, LG	LP	
Betriebstemperatur Operating temperature range	T_{op}	- 40 ... + 100		°C
Lagertemperatur Storage temperature range	T_{stg}	- 40 ... + 100		°C
Sperrschichttemperatur Junction temperature	T_j	+ 100		°C
Durchlassstrom Forward current ($T_A=25^\circ\text{C}$)	I_F	30		mA
Stoßstrom Surge current $t \leq 10 \mu\text{s}, D = 0.005, T_A=25^\circ\text{C}$	I_{FM}	0.5		A
Sperrspannung ¹⁾ Reverse voltage ($T_A=25^\circ\text{C}$)	V_R	12		V
Leistungsaufnahme Power consumption ($T_A=25^\circ\text{C}$)	P_{tot}	95	90	mW
Wärmewiderstand Thermal resistance Sperrschicht/Umgebung ²⁾ Junction/air ²⁾	$R_{th JA}$	480		K/W
Sperrschicht/Lötpad Junction/soldering point	$R_{th JS}$	230		K/W

¹⁾ für kurzzeitigen Betrieb geeignet / suitable for short term application

²⁾ Montage auf PC-Board FR 4 (Padgröße $\geq 5 \text{ mm}^2$)
mounted on PC board FR 4 (pad size $\geq 5 \text{ mm}^2$)

Kennwerte ($T_A = 25\text{ °C}$)

Characteristics

Bezeichnung Parameter	Symbol Symbol	Wert Value					Einheit Unit
		LS	LO	LY	LG	LP	
Wellenlänge des emittierten Lichtes (typ.) Wavelength at peak emission $I_F = 10\text{ mA}$	λ_{peak}	635	610	586	572	557	nm
Dominantwellenlänge ¹⁾ Dominant wavelength $I_F = 10\text{ mA}$	λ_{dom}	628 ± 6	606 ± 6	587 -7/+8	570 ± 6	560 ± 6	nm
Spektrale Bandbreite bei 50 % $I_{\text{rel max}}$ (typ.) Spectral bandwidth at 50 % $I_{\text{rel max}}$ $I_F = 10\text{ mA}$	$\Delta\lambda$	45	40	45	25	22	nm
Abstrahlwinkel bei 50 % I_V (Vollwinkel) (typ.) Viewing angle at 50 % I_V	2φ	120	120	120	120	120	Grad deg.
Durchlassspannung ²⁾ (typ.) Forward voltage (max.) $I_F = 10\text{ mA}$	V_F V_F	2.0 2.5	2.0 2.5	2.0 2.5	2.0 2.5	2.0 2.5	V V
Sperrstrom (typ.) Reverse current (max.) $V_R = 12\text{ V}$	I_R I_R	0.01 10	0.01 10	0.01 10	0.01 10	0.01 10	μA μA
Temperaturkoeffizient von λ_{peak} (typ.) Temperature coefficient of λ_{peak} $I_F = 10\text{ mA}; -10\text{ °C} \leq T \leq 100\text{ °C}$	$TC_{\lambda_{\text{peak}}}$	0.11	0.12	0.10	0.11	0.11	nm/K
Temperaturkoeffizient von λ_{dom} (typ.) Temperature coefficient of λ_{dom} $I_F = 10\text{ mA}; -10\text{ °C} \leq T \leq 100\text{ °C}$	$TC_{\lambda_{\text{dom}}}$	0.07	0.07	0.07	0.07	0.05	nm/K
Temperaturkoeffizient von V_F (typ.) Temperature coefficient of V_F $I_F = 10\text{ mA}; -10\text{ °C} \leq T \leq 100\text{ °C}$	TC_V	- 1.9	- 1.9	- 1.9	- 1.4	- 2.1	mV/K
Optischer Wirkungsgrad (typ.) Optical efficiency $I_F = 10\text{ mA}$	η_{opt}	1.5	1.5	1.5	2.5	0.6	lm/W

¹⁾ Wellenlängen werden mit einer Stromeinprägungsdauer von 25 ms und einer Genauigkeit von ±1 nm ermittelt.
Wavelengths are tested at a current pulse duration of 25 ms and a tolerance of ±1 nm.

²⁾ Spannungswerte werden mit einer Stromeinprägungsdauer von 1 ms und einer Genauigkeit von ±0,1 V ermittelt.
Voltages are tested at a current pulse duration of 1 ms and a tolerance of ±0.1 V.

1) Wellenlängengruppen für Dominantwellenlänge
Wavelength groups for dominant wavelength

Gruppe Group	yellow		orange		Einheit Unit
	min.	max.	min.	max.	
2	580	583	600	603	nm
3	583	586	603	606	nm
4	586	589	606	609	nm
5	589	592			nm
6	592	595			nm

Helligkeits-Gruppierungsschema
Luminous Intensity Groups

Lichtgruppe Luminous Intensity Group	Lichtstärke Luminous Intensity I_V (mcd)	Lichtstrom Luminous Flux Φ_V (mlm)
F2	1.40 ... 1.80	5 (typ.)
G1	1.80 ... 2.24	6 (typ.)
G2	2.24 ... 2.80	8 (typ.)
H1	2.80 ... 3.55	10 (typ.)
H2	3.55 ... 4.50	12 (typ.)
J1	4.50 ... 5.60	15 (typ.)
J2	5.60 ... 7.10	19 (typ.)
K1	7.10 ... 9.00	24 (typ.)
K2	9.00 ... 11.20	30 (typ.)
L1	11.20 ... 14.00	38 (typ.)
L2	14.00 ... 18.00	48 (typ.)
M1	18.00 ... 22.40	60 (typ.)

Helligkeitswerte werden mit einer Stromeinprägedauer von 25 ms und einer Genauigkeit von $\pm 11\%$ ermittelt.
Luminous intensity is tested at a current pulse duration of 25 ms and a tolerance of $\pm 11\%$.

Gruppenbezeichnung auf Etikett
Group Name on Label

Beispiel: L1-3

Example: L1-3

Lichtgruppe Luminous Intensity Group	Halbgruppe Half Group	Wellenlänge Wavelength
L	1	3

Relative spektrale Emission $I_{rel} = f(\lambda)$, $T_A = 25\text{ °C}$, $I_F = 10\text{ mA}$

Relative Spectral Emission

$V(\lambda)$ = spektrale Augenempfindlichkeit

Standard eye response curve

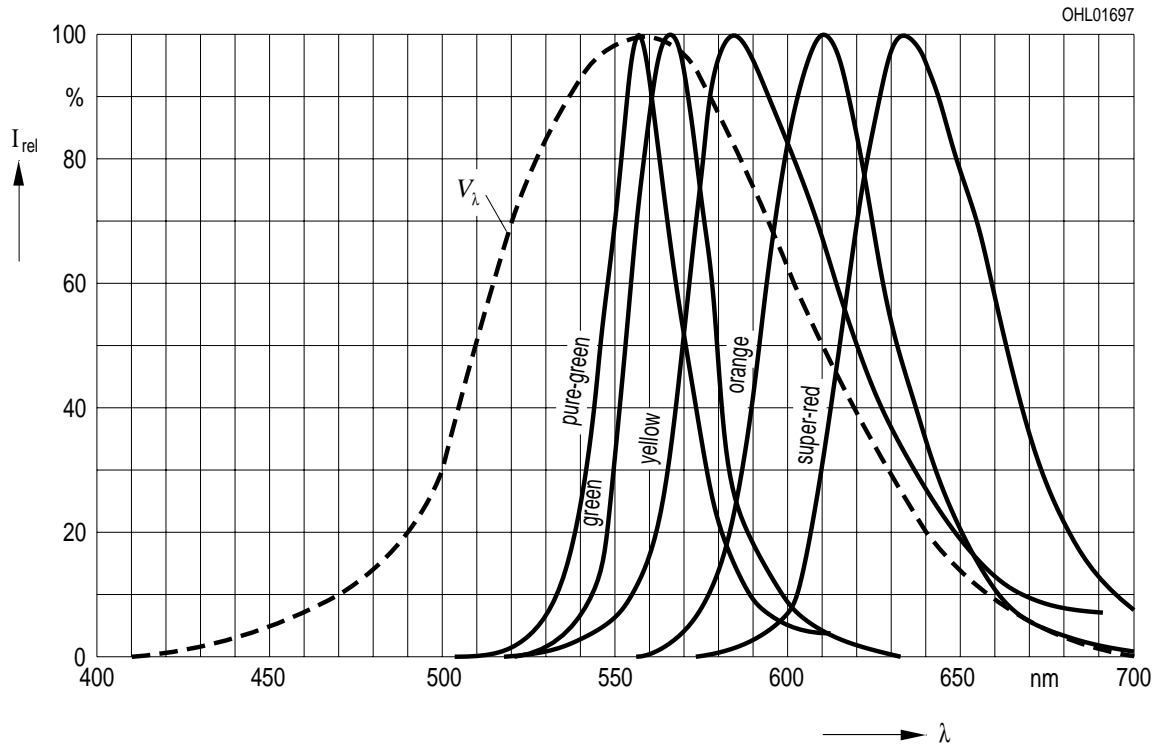

Abstrahlcharakteristik $I_{rel} = f(\varphi)$

Radiation Characteristic

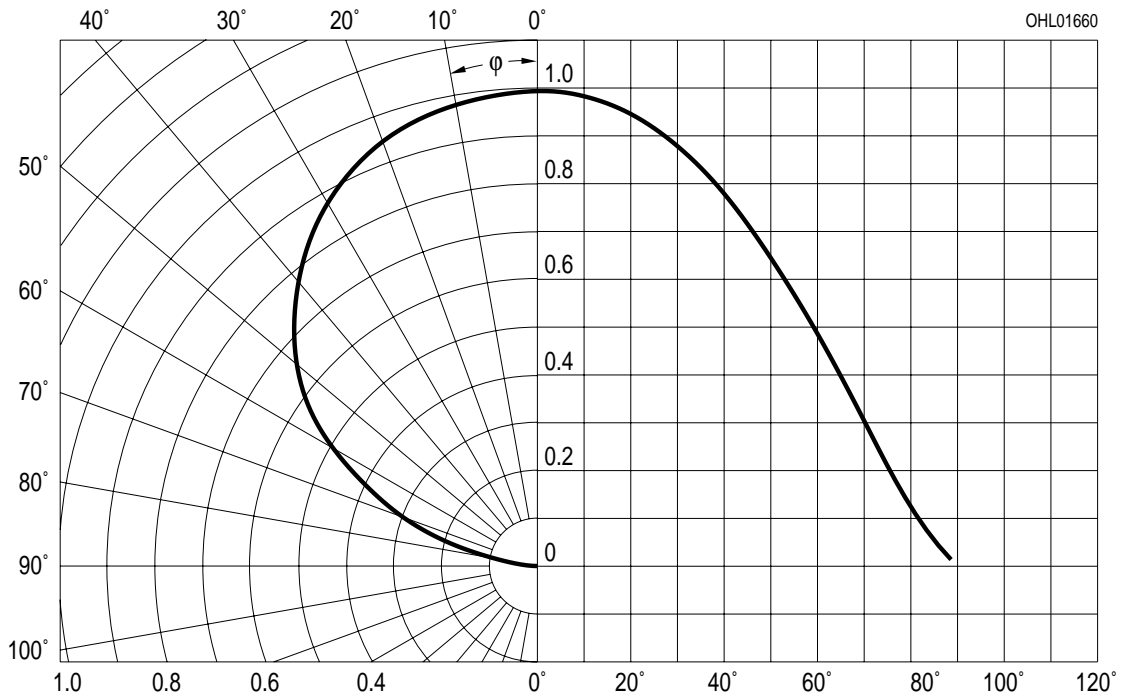

Durchlassstrom $I_F = f(V_F)$
Forward Current

$T_A = 25\text{ }^\circ\text{C}$

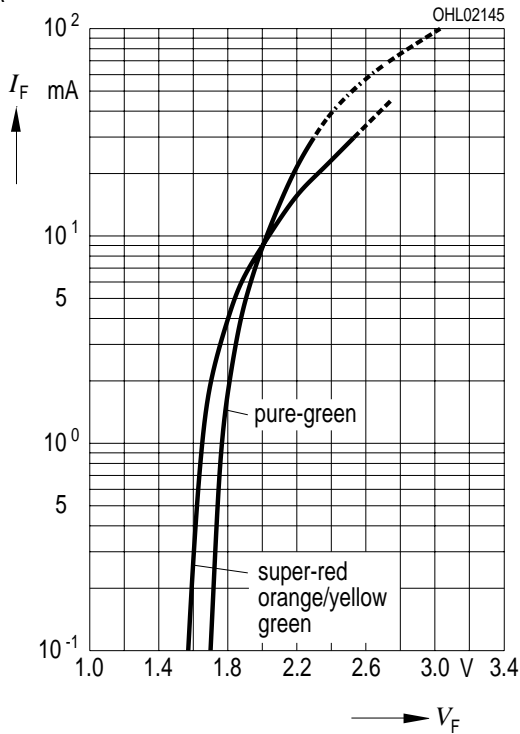

Relative Lichtstärke $I_V/I_{V(10\text{ mA})} = f(I_F)$
Relative Luminous Intensity

$T_A = 25\text{ }^\circ\text{C}$

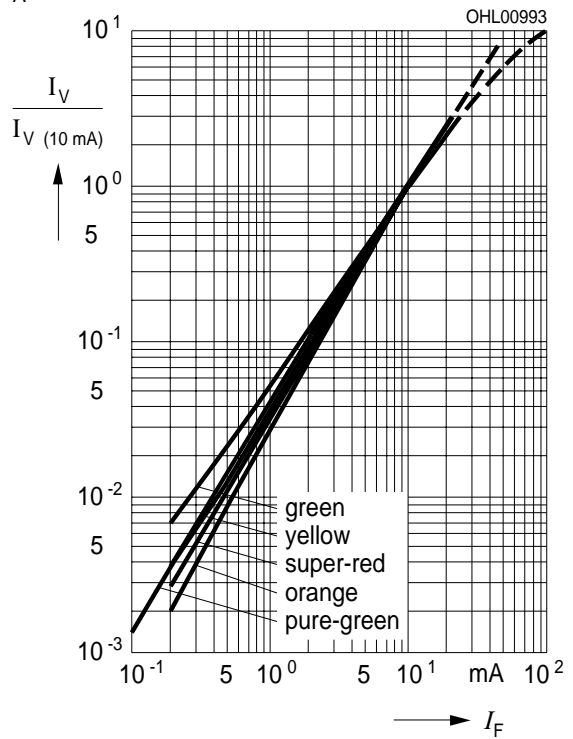

Maximal zulässiger Durchlassstrom $I_F = f(T_A)$
Max. Permissible Forward Current

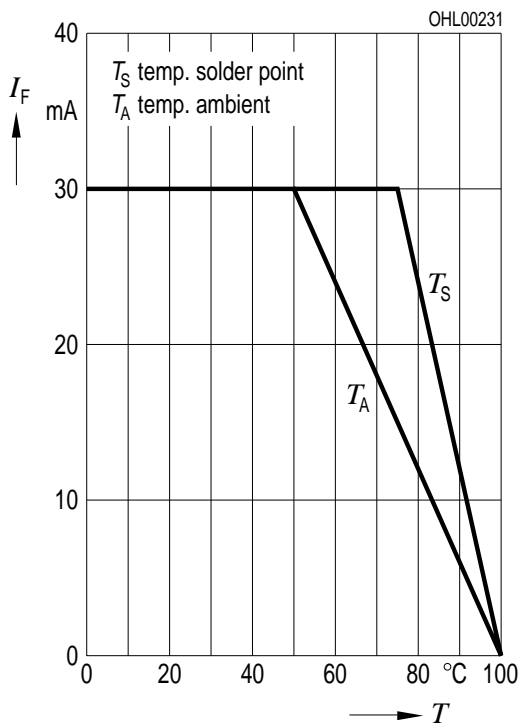

Relative Lichtstärke $I_V / I_{V(25\text{ }^\circ\text{C})} = f(T_A)$
Relative Luminous Intensity

$I_F = 10\text{ mA}$

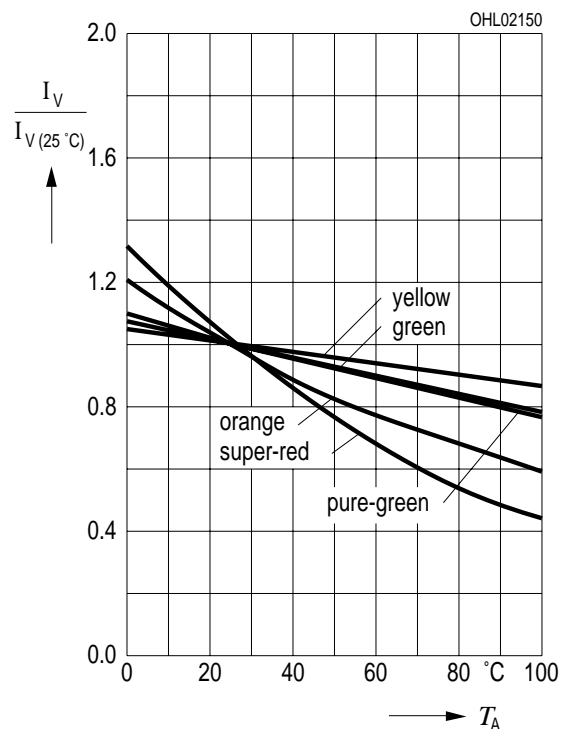

Zulässige Impulsbelastbarkeit $I_F = f(t_p)$
Permissible Pulse Handling Capability

Duty cycle $D =$ parameter, $T_A = 25\text{ °C}$

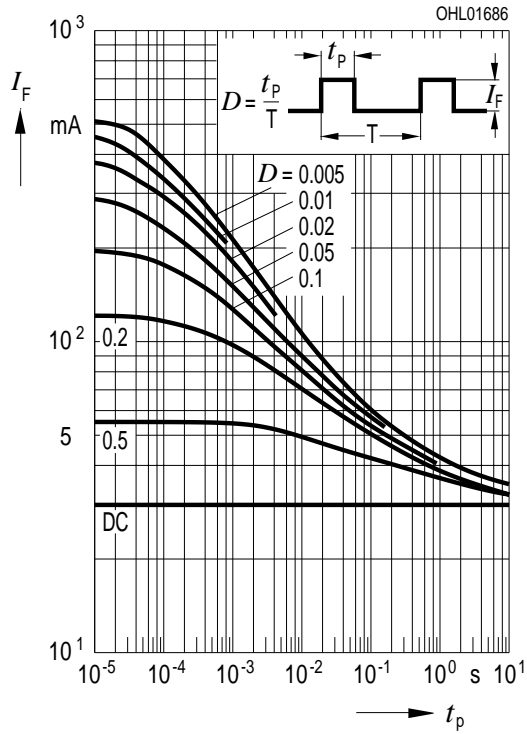

Maßzeichnung
Package Outlines

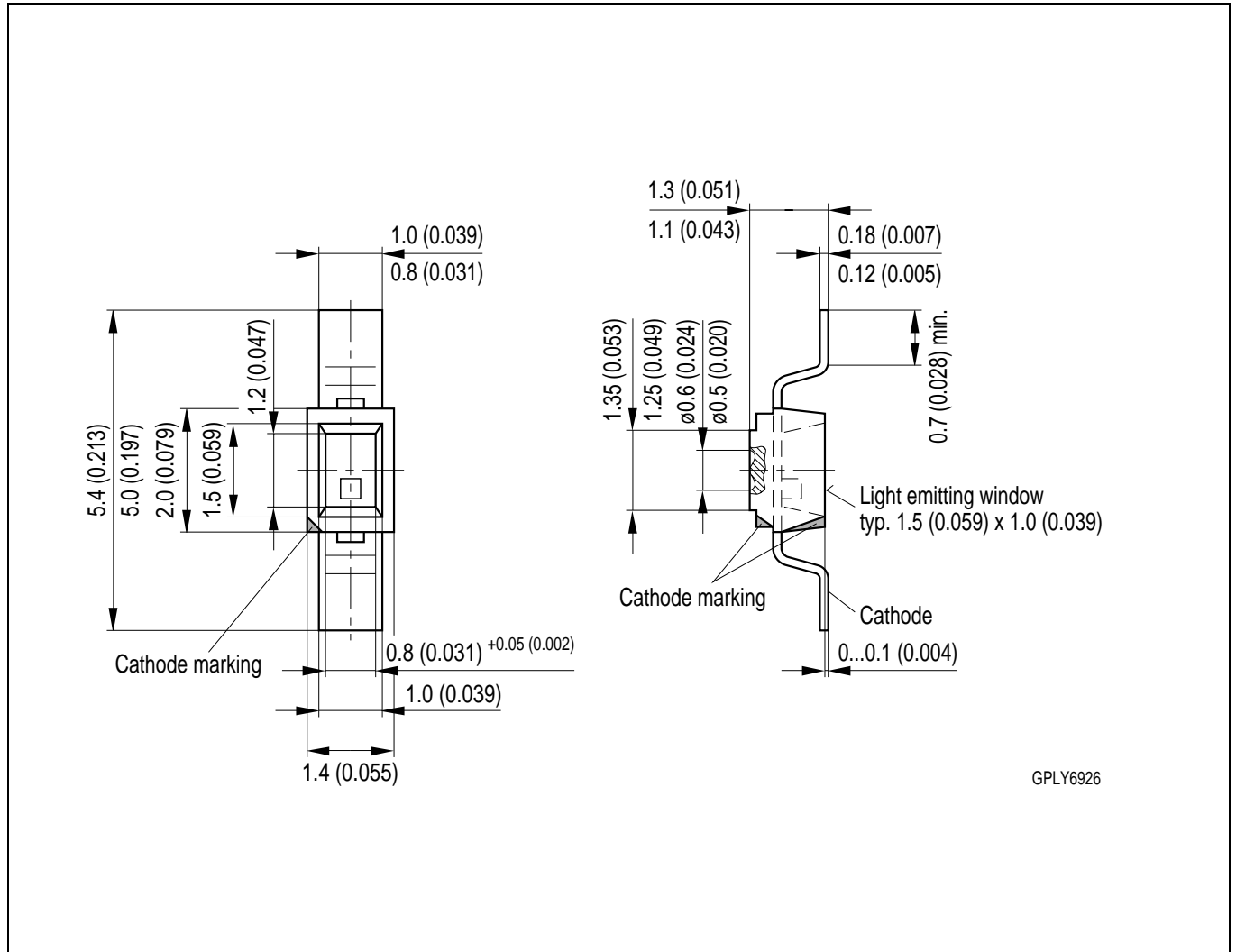

Maße werden wie folgt angegeben: mm (inch) / Dimensions are specified as follows: mm (inch).

Kathodenkennung: abgeschrägte Ecke
Cathode mark: bevelled edge
Gewicht / Approx. weight: 10 mg

Lötbedingungen Vorbehandlung nach JEDEC Level 2
Soldering Conditions Preconditioning acc. to JEDEC Level 2

IR-Reflow Lötprofil (nach IPC 9501)
IR Reflow Soldering Profile (acc. to IPC 9501)

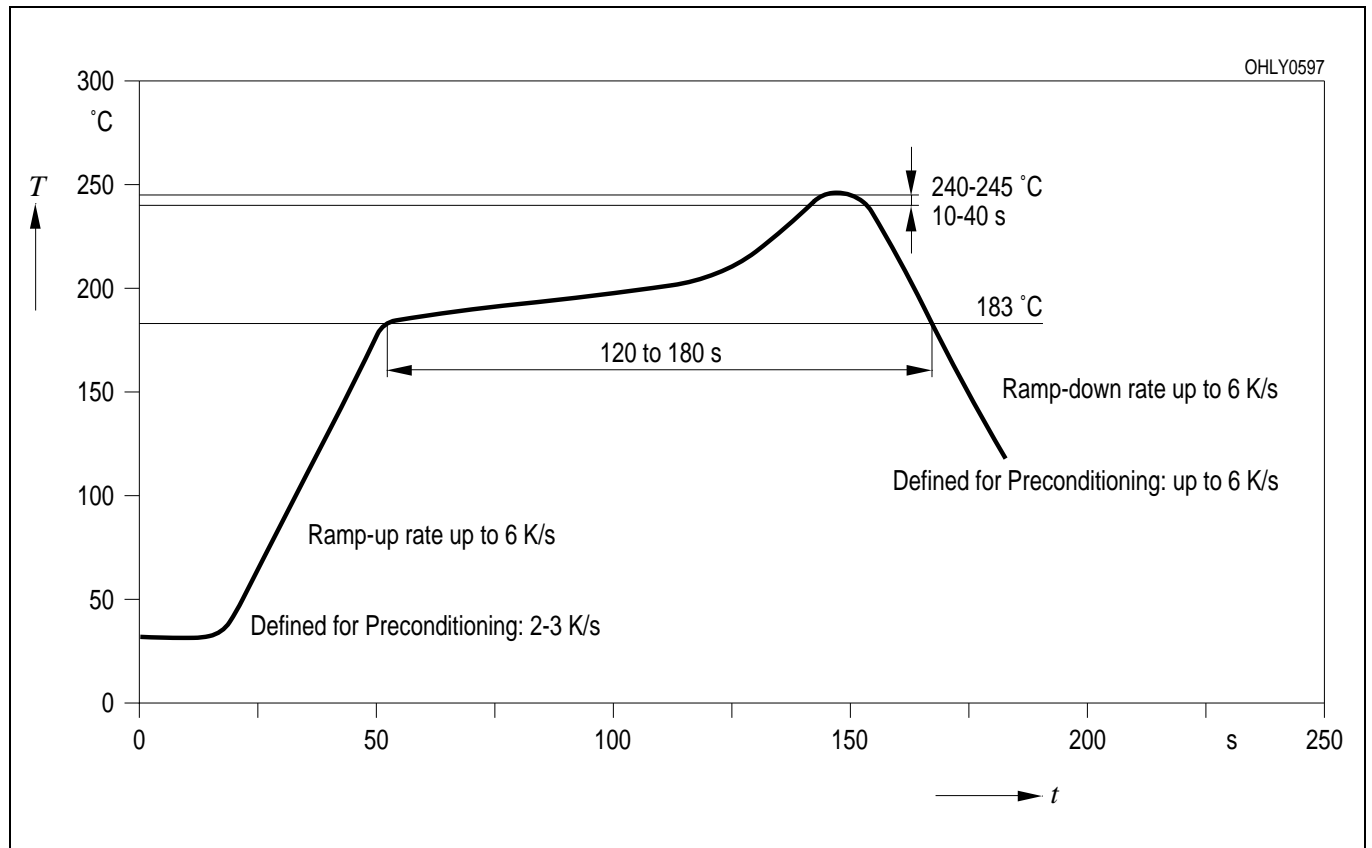

Wellenlöten (TTW) (nach CECC 00802)
TTW Soldering (acc. to CECC 00802)

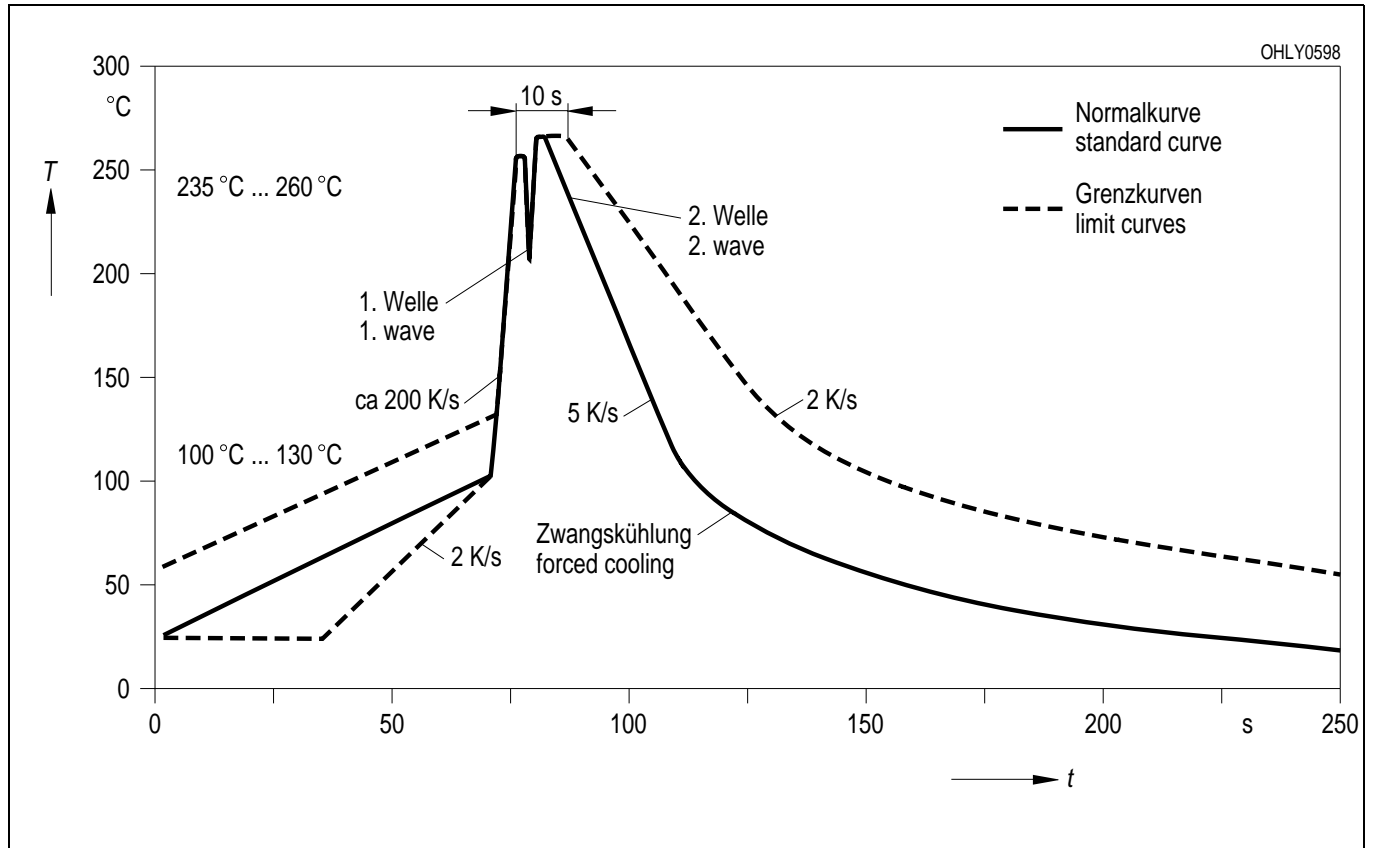

Empfohlenes Lötpadesign IR Reflow Löten
Recommended Solder Pad IR Reflow Soldering

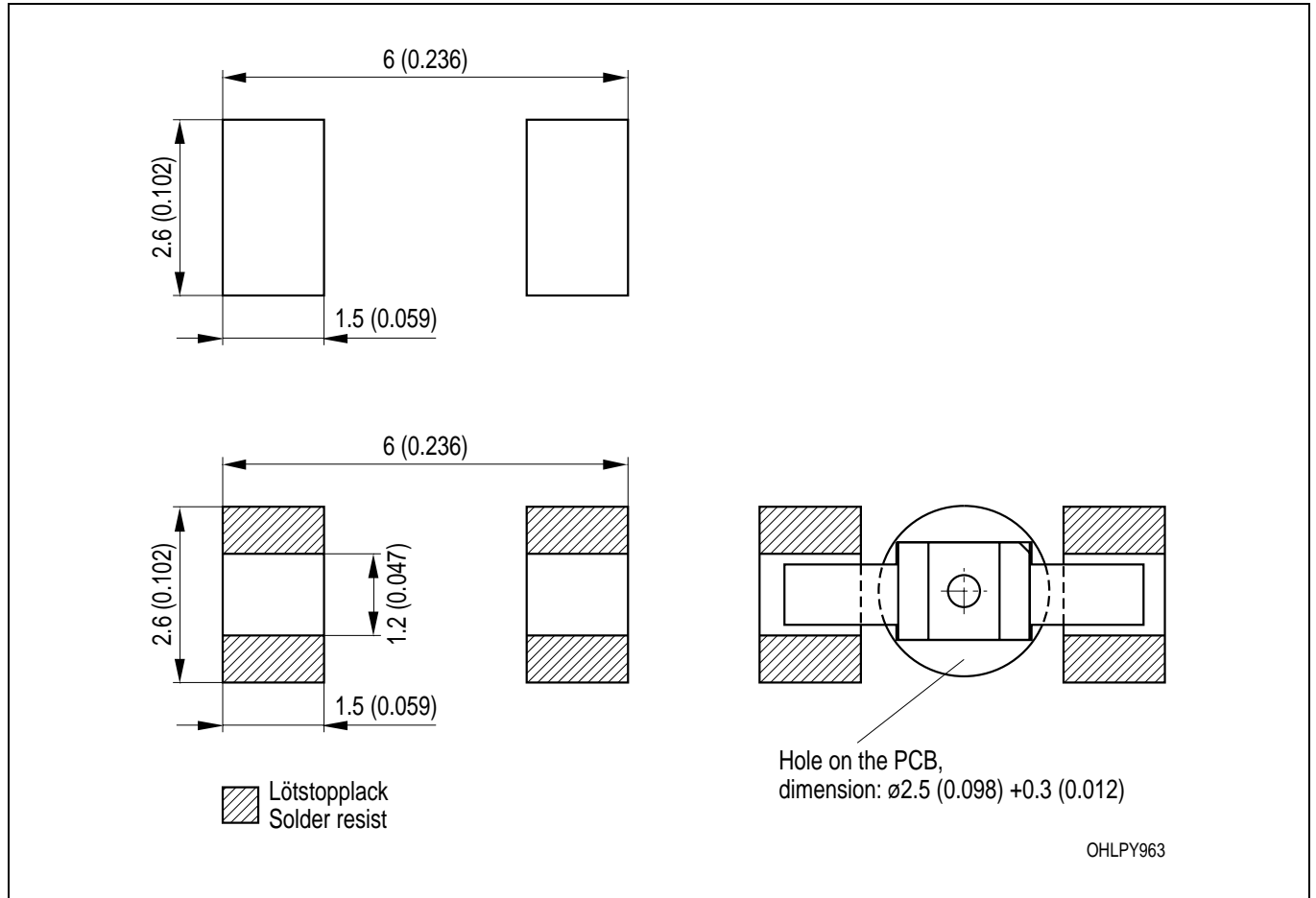

Maße werden wie folgt angegeben: mm (inch) / Dimensions are specified as follows: mm (inch).
 Gehäuse hält TTW-Löthitze aus / Package able to withstand TTW-soldering heat

LS M770, LO M770, LY M770, LG M770, LP M770

Gurtung / Polarität und Lage

Verpackungseinheit 3000/Rolle, \varnothing 180 mm oder
11800/Rolle, \varnothing 330 mm

Method of Taping / Polarity and Orientation

Packing unit 3000/reel, \varnothing 180 mm or 11800/reel, \varnothing 330 mm

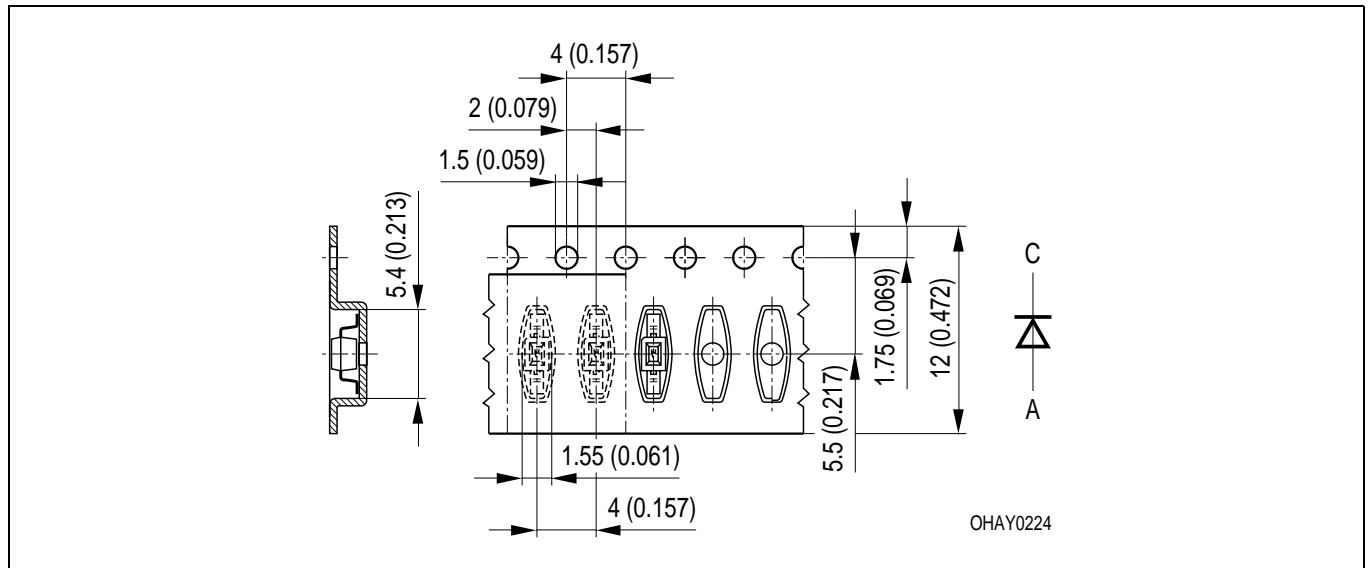

Maße werden wie folgt angegeben: mm (inch) / Dimensions are specified as follows: mm (inch).

Anm.: Bezüglich Trockenverpackung finden Sie weitere Hinweise im Internet und in unserem Short Form Catalog im Kapitel "Gurtung und Verpackung" unter dem Punkt "Trockenverpackung". Hier sind Normenbezüge, unter anderem ein Auszug der JEDEC-Norm, enthalten.

Note: Regarding dry pack you will find further information in the internet and in the Short Form Catalog in chapter "Tape and Reel" under the topic "Dry Pack". Here you will also find the normative references like JEDEC.

Revision History: 2003-09-03		Date of change
Previous Version: 2003-08-04		
Page	Subjects (major changes since last revision)	
5	wavelength groups	
2	wavelength grouping for yellow and orange	
3	pad size from 16 mm ² to 5 mm ²	
1	insertion of "Not for new designs..."	2002-06-14
13	annotations	2002-07-23
3, 4	value (reverse voltage from 5 V to 12 V)	2002-09-18
1, 12	removal: pad for TTW soldering	2002-09-30
5	new luminous flux Φ_V (mlm)	2003-02-17
7	diagram relative luminous intensity $f(I_F)$	2003-03-13
1, 2	Obsolete	2003-08-04
14	note: dry pack	2003-09-03
1	ESD norm	2003-09-03
3	ambient temperature	2003-09-03

Published by OSRAM Opto Semiconductors GmbH
 Wernerwerkstrasse 2, D-93049 Regensburg

© All Rights Reserved.

Attention please!

The information describes the type of component and shall not be considered as assured characteristics.

All typical data and graphs are basing on representative samples, but don't represent the production range. If requested, e.g. because of technical improvements, these typ. data will be changed without any further notice.

Terms of delivery and rights to change design reserved. Due to technical requirements components may contain dangerous substances. For information on the types in question please contact our Sales Organization.

If printed or downloaded, please find the latest version in the Internet.

Packing

Please use the recycling operators known to you. We can also help you – get in touch with your nearest sales office. By agreement we will take packing material back, if it is sorted. You must bear the costs of transport. For packing material that is returned to us unsorted or which we are not obliged to accept, we shall have to invoice you for any costs incurred.

Components used in life-support devices or systems must be expressly authorized for such purpose! Critical components ¹ may only be used in life-support devices or systems ² with the express written approval of OSRAM OS.

¹ A critical component is a component used in a life-support device or system whose failure can reasonably be expected to cause the failure of that life-support device or system, or to affect its safety or the effectiveness of that device or system.

² Life support devices or systems are intended (a) to be implanted in the human body, or (b) to support and/or maintain and sustain human life. If they fail, it is reasonable to assume that the health of the user may be endangered.