

SEK – Insulation Displacement Connector system (IDC), 2.54 mm pitch

Page

General information **09.02**

Solder board connectors

Technical characteristics **09.04**

Male standard connectors **09.06**

Male standard connectors, kinked **09.10**

Male standard connectors with board lock **09.12**

Male low-profile connectors **09.14**

Accessories **09.16**

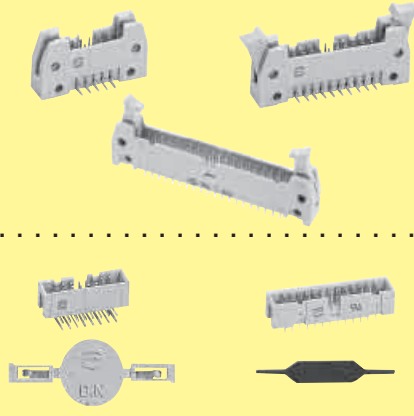

Wrap post connectors

Technical characteristics **09.17**

Male standard connectors **09.18**

Accessories **09.20**



Cable connectors

Technical characteristics for female connectors **09.21**

Female connectors **09.22**

Technical characteristics for pcb transition connectors, 2 rows **09.24**

Pcb transition connectors, 2 rows **09.25**

Technical characteristics for pcb transition connectors, 4 rows **09.28**

Pcb transition connectors, 4 rows **09.29**

Technical characteristics for DIP connectors **09.30**



DIP connectors **09.31**

Technical characteristics for DIN 41 612 connectors **09.32**

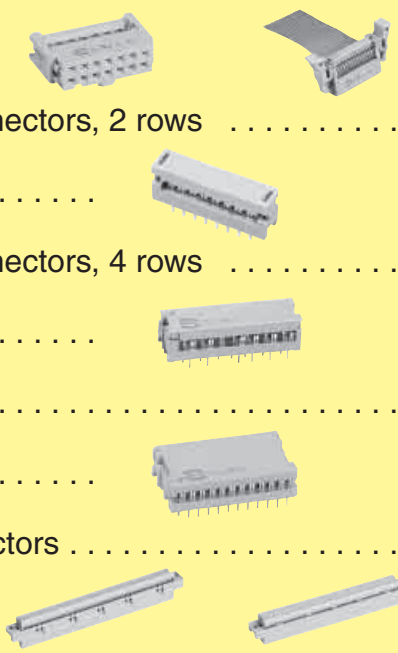
DIN 41 612 connectors **09.33**

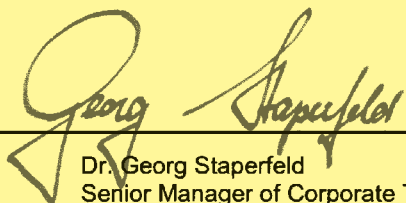
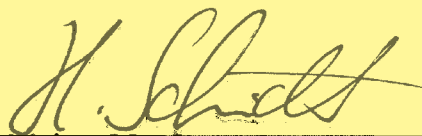

Declaration of conformity

<p><i>This Declaration of Conformity is suitable to the European Standard EN 45 014, „General criteria for suppliers declaration of conformity“.</i></p> <p><i>The basis for the criteria has been found in international documentation, particularly in ISO/IEC Guide 22, 1996, „Information on manufacturers declaration of conformity with standards or other technical specifications“.</i></p>	<p>We</p> <p>HARTING KGaA</p> <p>Marienwerder Str. 3 32339 Espelkamp</p> <p>HARTING Electronics GmbH & Co KG Marienwerder Str.3 32339 Espelkamp</p> <p>declare under our own responsibility that the</p> <p style="text-align: center;">Flat Cable Connector System</p> <p>is in conformity with the following standard IEC 60603-13 Connectors for frequencies below 3MHz for use with printed board-Part 13: Detail specification for two-part connectors with assessed quality, for printed boards, for basic grid of 2,54 mm (0,1in) with free connectors for non – accessible insulation displacement termination (ID)</p> <p>This declaration of conformity refers to the series:</p> <p style="text-align: center;">SEK</p>
	<p>Our testing laboratory is accredited and monitored by the German Accreditation Body Technology/ (DATech). Reg.-Nr. DAT-P-041/94-02</p>
<p>QUALITY SYSTEM</p> 	<p>Our quality system is certified and monitored by DQS in conformity with the standard DIN EN ISO 9001 : 2000. Cert.-Nr. 002204 QM</p>
<p><u>Espekamp, 2004-11-18</u> Place and Date of publication</p>	 <p>Dr. Georg Staperfeld Senior Manager of Corporate Technology Services</p>
<p><u>Espekamp, 2004-11-18</u> Place and Date of publication</p>	 <p>Dipl.-Ing. Hartmuth Schmidt Director Global Product Management HARTING Electronics GmbH & Co KG</p>

The HARTING Insulation Displacement Connector system

Economic and reliable connections

The flat cable and connector can be preassembled and used as a component with predetermined functional characteristics.

The HARTING insulation displacement contacts pierce the insulation on the flat cable to provide a durable gastight connection with the wire.

The HARTING¹⁾ insulation displacement technique constitutes the ideal solution to your wiring problems.

¹⁾ The HARTING insulation displacement system meets all the characteristics, specifications and test conditions of IEC 60352-4.

For "non standard applications" we can manufacture designs to match your requirements.

Please discuss requirements with us.

HARTING SEK connectors incorporate the latest design features and provide the assurance of high quality and reliability with economy.

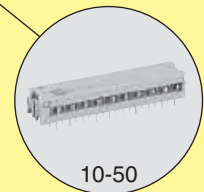
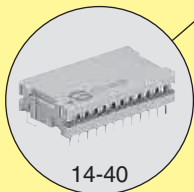
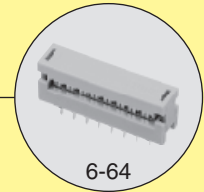
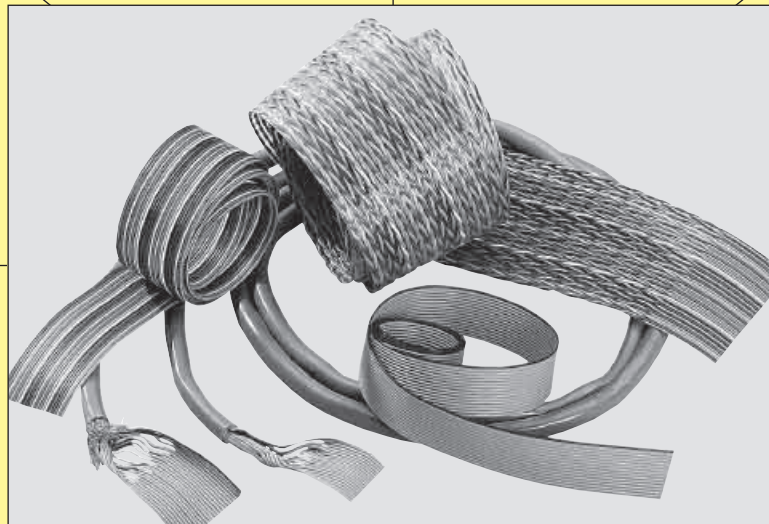
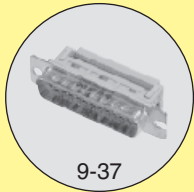
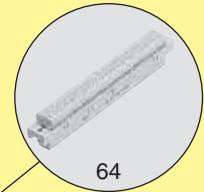
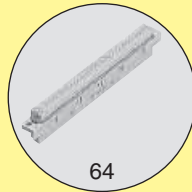
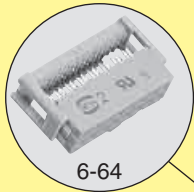

Cable assemblies

- HARTING can supply cable assemblies to customer specifications.
- A wide range of connector types available with various contact arrangements constitute the ideal solution to your wiring problems.
- Cables of all types in economic reel lengths are available.

Quality

- Cables professionally assembled on HARTING work stations ensure reliable connections.
- Finished harnesses are subject to 100% quality checks on a HARTING test device.
- Insulation test.
- Contact resistance test.

Economy

- The tested assembly of connectors and flat cables from one manufacturer guarantees a high degree of economy and reliability.
- Investment for work stations and test devices are not required.
- Stocks of piece parts are reduced.

Number of contacts 6, 10, 14, 16, 20, 26, 30*, 34, 40, 50, 60, 64

Contact arrangement straight, angled

Contact length 2.9 mm, 4.5 mm

Approvals IEC 60603-13
DIN EN 60603-13
D 2632
BT 224
NFC 93-428 (HE 10)

UL recognized: E102079
comply with MIL DTL 83503



Pitch 2.54 mm [0.100"]

Working current 1 A

Working voltage 500 V
for pollution degree 1

Test voltage $U_{r.m.s.}$ 1 kV

Contact resistance $\leq 20 \text{ m}\Omega$
Insulation resistance $\geq 10^9 \Omega$

Temperature range -55 °C ... + 125 °C
The maximum temperature includes heating of contacts and ambient temperature

Terminations For pcb hole $\varnothing 1 \pm 0.1 \text{ mm}$
DIN IEC 52 141
Diagonal: 0.79 mm

Materials Moulding Thermoplastic resin (PBTP)
UL 94-V0

Contact surface Contact zone gold-plated according to performance level¹⁾

Current carrying capacity

The current carrying capacity is limited by maximum temperature of materials for inserts and contacts including terminals. The current capacity-curve is valid for continuous, not interrupted current-loaded contacts of connectors when simultaneous power on all contacts is given, without exceeding the maximum temperature.

Control and test procedures according to DIN IEC 60512.

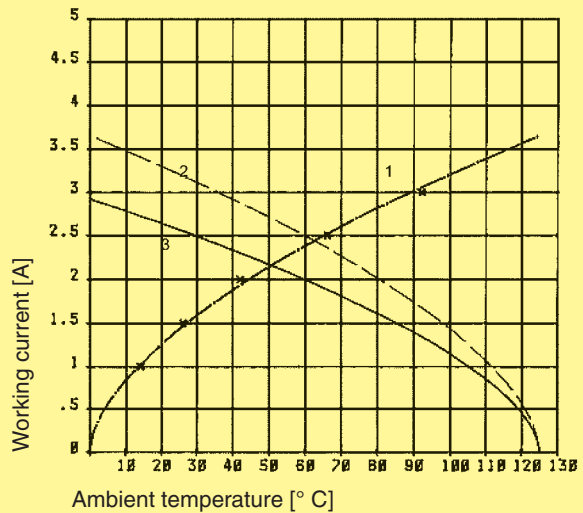

Example: 50 way connector

- ① Temperature rise
- ② Derating
- ③ Derating curve at $I_{max} \times 0.8$ (IEC 60512-2)

Insertion and withdrawal forces

Number of contacts	Maximum force [N]	
	Performance level 1 and 2	Performance level 3
6	12	18
10	20	30
14	28	42
16	32	48
20	40	60
26	52	78
30	60	90
34	68	102
40	80	120
50	100	150
60	120	180
64	128	192

SEK

¹⁾ Performance level 3 as per IEC 60603-13, ≥ 50 mating cycles, no gas test
Performance level 2 as per IEC 60603-13, ≥ 250 mating cycles, 4 days gas test
as per MIL DTL 83503, $> 0.76 \mu\text{m Au}$ ($30 \mu \text{inch}$), other performance levels on request

* on request

Number of contacts

6-64

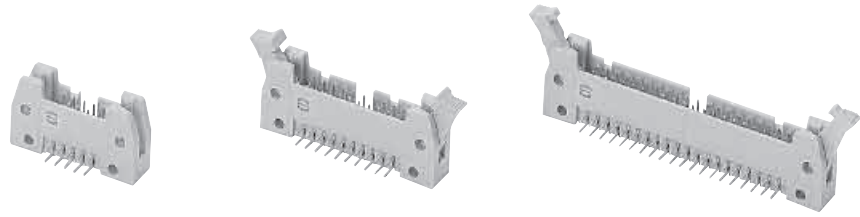

Male header with angled solder pins

Identification	No. of contacts	Part No.					
		Without levers		With short levers		With long levers	
Male header with angled solder pins Length: 2.9 mm							
	6	09 18 506	└ 923	09 18 506	└ 913	09 18 506	└ 903
	10	09 18 510	└ 923	09 18 510	└ 913	09 18 510	└ 903
	14	09 18 514	└ 923	09 18 514	└ 913	09 18 514	└ 903
	16	09 18 516	└ 923	09 18 516	└ 913	09 18 516	└ 903
	20	09 18 520	└ 923	09 18 520	└ 913	09 18 520	└ 903
	26	09 18 526	└ 923	09 18 526	└ 913	09 18 526	└ 903
	34	09 18 534	└ 923	09 18 534	└ 913	09 18 534	└ 903
	40	09 18 540	└ 923	09 18 540	└ 913	09 18 540	└ 903
	50	09 18 550	└ 923	09 18 550	└ 913	09 18 550	└ 903
	60	09 18 560	└ 923	09 18 560	└ 913	09 18 560	└ 903
	64	09 18 564	└ 923	09 18 564	└ 913	09 18 564	└ 903
30 contacts and kinked version on request							
Male header with angled solder pins Length: 4.5 mm							
	6	09 18 506	└ 921*	09 18 506	└ 911*	09 18 506	└ 901*
	10	09 18 510	└ 921*	09 18 510	└ 911*	09 18 510	└ 901*
	14	09 18 514	└ 921*	09 18 514	└ 911*	09 18 514	└ 901*
	16	09 18 516	└ 921*	09 18 516	└ 911*	09 18 516	└ 901*
	20	09 18 520	└ 921*	09 18 520	└ 911*	09 18 520	└ 901*
	26	09 18 526	└ 921*	09 18 526	└ 911*	09 18 526	└ 901*
	34	09 18 534	└ 921*	09 18 534	└ 911*	09 18 534	└ 901*
	40	09 18 540	└ 921*	09 18 540	└ 911*	09 18 540	└ 901*
	50	09 18 550	└ 921*	09 18 550	└ 911*	09 18 550	└ 901*
	60	09 18 560	└ 921*	09 18 560	└ 911*	09 18 560	└ 901*
	64	09 18 564	└ 921*	09 18 564	└ 911*	09 18 564	└ 901*
30 contacts and kinked version on request							

SEK

09-06

* Not normally kept in stock
For accessories see page 09.16
For dimensions see page 09.07

For performance level 3 please specify digit
For performance level 2 please specify digit
> 0.76 µm Au (30 µinch) on request



Number of contacts

6-64

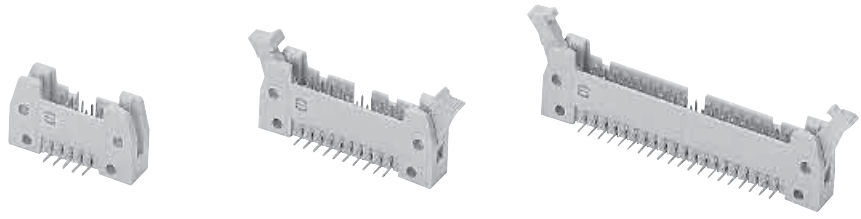

Male header with angled solder pins

Identification

Drawing

Dimensions in mm

Male header

No. of contacts	A	B	D	E	F	G
6	26.9	16.76	12.45	2.54 x 2 = 5.08	36.9	40.3
10	32.0	21.84	17.53	2.54 x 4 = 10.16	42.0	45.4
14	37.1	26.92	22.61	2.54 x 6 = 15.24	47.1	50.4
16	39.6	29.46	25.15	2.54 x 7 = 17.78	49.6	53.0
20	44.7	34.54	30.23	2.54 x 9 = 22.86	54.7	58.1
26	52.3	42.16	37.85	2.54 x 12 = 30.48	62.3	65.7
34	62.5	52.32	48.01	2.54 x 16 = 40.64	72.5	75.8
40	70.1	59.94	55.63	2.54 x 19 = 48.26	80.1	83.5
50	82.8	72.64	68.33	2.54 x 24 = 60.96	92.8	96.2
60	95.5	85.34	81.03	2.54 x 29 = 73.66	105.5	108.9
64	100.6	90.42	86.11	2.54 x 31 = 78.74	110.6	113.9

Short levers

for use with female connector without strain relief clamp

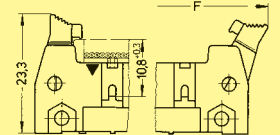
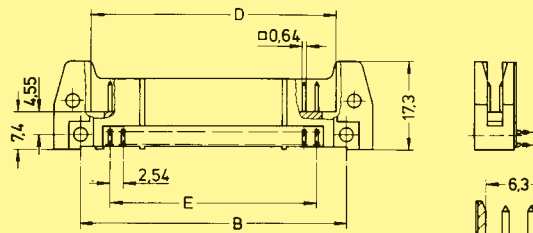

Long levers

for use with female connector with strain relief clamp

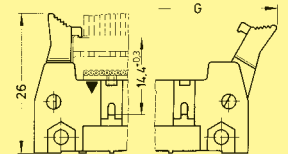
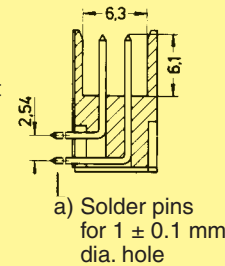
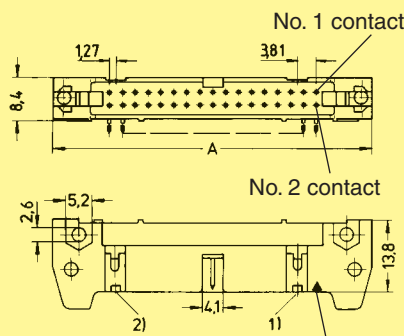

a) Solder pins for 1 ± 0.1 mm dia. hole

Marking No. 1 contact

No. 1 contact

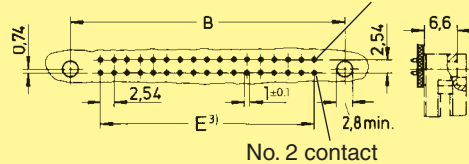

No. 2 contact

Board drillings

For accessories see page 09.16

¹⁾ No polarization slot for 6, 10 or 14 way male header

²⁾ No polarization slot for 6 way male header

³⁾ Pitch tolerance: ± 0.1

Number of contacts

6-64

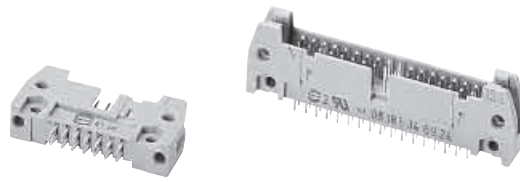

Male header with straight solder pins

Identification	No. of contacts	Part No.					
		Without levers		With short levers		With long levers	
Male header with straight solder pins Length: 2.9 mm							
	6	09 18 506	└ 924	09 18 506	└ 914	09 18 506	└ 904
	10	09 18 510	└ 924	09 18 510	└ 914	09 18 510	└ 904
	14	09 18 514	└ 924	09 18 514	└ 914	09 18 514	└ 904
	16	09 18 516	└ 924	09 18 516	└ 914	09 18 516	└ 904
	20	09 18 520	└ 924	09 18 520	└ 914	09 18 520	└ 904
	26	09 18 526	└ 924	09 18 526	└ 914	09 18 526	└ 904
	34	09 18 534	└ 924	09 18 534	└ 914	09 18 534	└ 904
	40	09 18 540	└ 924	09 18 540	└ 914	09 18 540	└ 904
	50	09 18 550	└ 924	09 18 550	└ 914	09 18 550	└ 904
	60	09 18 560	└ 924	09 18 560	└ 914	09 18 560	└ 904
	64	09 18 564	└ 924	09 18 564	└ 914	09 18 564	└ 904
30 contacts on request							
Male header with straight solder pins Length: 4.5 mm							
	6	09 18 506	└ 922*	09 18 506	└ 912*	09 18 506	└ 902*
	10	09 18 510	└ 922*	09 18 510	└ 912*	09 18 510	└ 902*
	14	09 18 514	└ 922*	09 18 514	└ 912*	09 18 514	└ 902*
	16	09 18 516	└ 922*	09 18 516	└ 912*	09 18 516	└ 902*
	20	09 18 520	└ 922*	09 18 520	└ 912*	09 18 520	└ 902*
	26	09 18 526	└ 922*	09 18 526	└ 912*	09 18 526	└ 902*
	34	09 18 534	└ 922*	09 18 534	└ 912*	09 18 534	└ 902*
	40	09 18 540	└ 922*	09 18 540	└ 912*	09 18 540	└ 902*
	50	09 18 550	└ 922*	09 18 550	└ 912*	09 18 550	└ 902*
	60	09 18 560	└ 922*	09 18 560	└ 912*	09 18 560	└ 902*
	64	09 18 564	└ 922*	09 18 564	└ 912*	09 18 564	└ 902*
30 contacts and kinked version on request							

SEK

09-08

* Not normally kept in stock
For accessories see page 09.16
For dimensions see page 09.09

For performance level 3 please specify digit
For performance level 2 please specify digit
> 0.76 µm Au (30 µinch) on request



Number of contacts

6-64

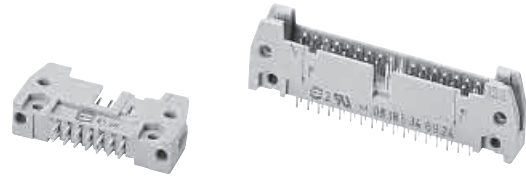

Male header with straight solder pins

Identification

Drawing

Dimensions in mm

Male header

No. of contacts	A	C	D	E	F	G
6	26.9	22.86	12.45	2.54 x 2 = 5.08	36.9	40.3
10	32.0	27.94	17.53	2.54 x 4 = 10.16	42.0	45.4
14	37.1	33.02	22.61	2.54 x 6 = 15.24	47.1	50.4
16	39.6	35.56	25.15	2.54 x 7 = 17.78	49.6	53.0
20	44.7	40.64	30.23	2.54 x 9 = 22.86	54.7	58.1
26	52.3	48.26	37.85	2.54 x 12 = 30.48	62.3	65.7
34	62.5	58.42	48.01	2.54 x 16 = 40.64	72.5	75.8
40	70.1	66.04	55.63	2.54 x 19 = 48.26	80.1	83.5
50	82.8	78.74	68.33	2.54 x 24 = 60.96	92.8	96.2
60	95.5	91.44	81.03	2.54 x 29 = 73.66	105.5	108.9
64	100.6	96.52	86.11	2.54 x 31 = 78.74	110.6	113.9

Short levers

for use with female connector without strain relief clamp

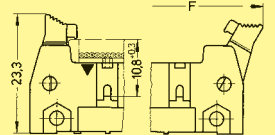
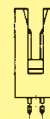
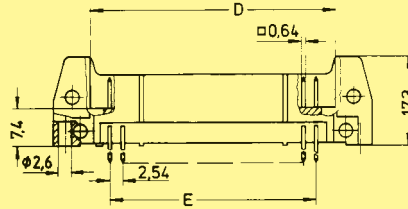

Long levers

for use with female connector with strain relief clamp

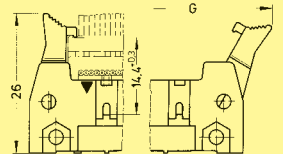
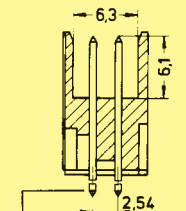
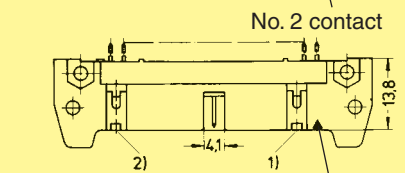
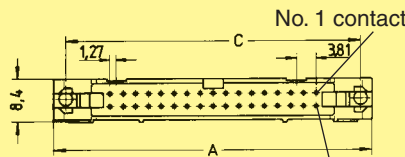

Marking No. 1 contact

No. 1 contact

Board drillings

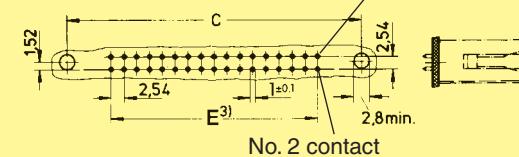

For accessories see page 09.16

¹⁾ No polarization slot for 6, 10 or 14 way male header

²⁾ No polarization slot for 6 way male header

³⁾ Pitch tolerance: ± 0.1

Number of contacts

6-64

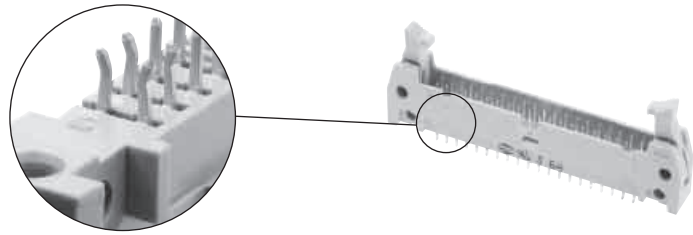

Male header with straight solder pins, kinked

Identification	No. of contacts	Part No.						
		Without levers		With short levers		With long levers		
Male header with straight solder pins, kinked Length: 2.9 mm	6	09 18 506	└ 024	09 18 506	└ 014	09 18 506	└ 004	
	10	09 18 510	└ 024	09 18 510	└ 014	09 18 510	└ 004	
	14	09 18 514	└ 024	09 18 514	└ 014	09 18 514	└ 004	
	16	09 18 516	└ 024	09 18 516	└ 014	09 18 516	└ 004	
	20	09 18 520	└ 024	09 18 520	└ 014	09 18 520	└ 004	
	26	09 18 526	└ 024	09 18 526	└ 014	09 18 526	└ 004	
	34	09 18 534	└ 024	09 18 534	└ 014	09 18 534	└ 004	
	40	09 18 540	└ 024	09 18 540	└ 014	09 18 540	└ 004	
	50	09 18 550	└ 024	09 18 550	└ 014	09 18 550	└ 004	
	60	09 18 560	└ 024	09 18 560	└ 014	09 18 560	└ 004	
	64	09 18 564	└ 024	09 18 564	└ 014	09 18 564	└ 004	
	30 contacts on request							

SEK

09
10

* Not normally kept in stock
 For accessories see page 09.16
 For dimensions see page 09.11

For performance level 3 please specify digit
 For performance level 2 please specify digit
 > 0.76 µm Au (30 µinch) on request



Number of contacts

6-64

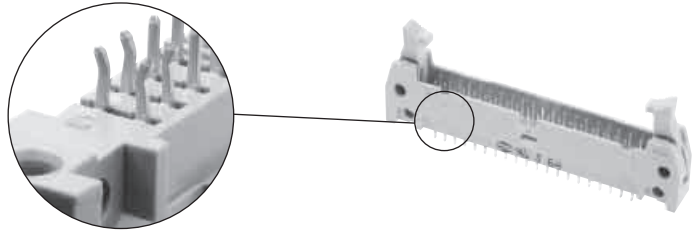

Male header with straight solder pins, kinked

Identification

Drawing

Dimensions in mm

Male header

No. of contacts	A	C	D	E	F	G
6	26.9	22.86	12.45	2.54 x 2 = 5.08	36.9	40.3
10	32.0	27.94	17.53	2.54 x 4 = 10.16	42.0	45.4
14	37.1	33.02	22.61	2.54 x 6 = 15.24	47.1	50.4
16	39.6	35.56	25.15	2.54 x 7 = 17.78	49.6	53.0
20	44.7	40.64	30.23	2.54 x 9 = 22.86	54.7	58.1
26	52.3	48.26	37.85	2.54 x 12 = 30.48	62.3	65.7
34	62.5	58.42	48.01	2.54 x 16 = 40.64	72.5	75.8
40	70.1	66.04	55.63	2.54 x 19 = 48.26	80.1	83.5
50	82.8	78.74	68.33	2.54 x 24 = 60.96	92.8	96.2
60	95.5	91.44	81.03	2.54 x 29 = 73.66	105.5	108.9
64	100.6	96.52	86.11	2.54 x 31 = 78.74	110.6	113.9

Short levers

for use with female connector without strain relief clamp

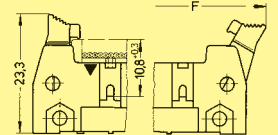
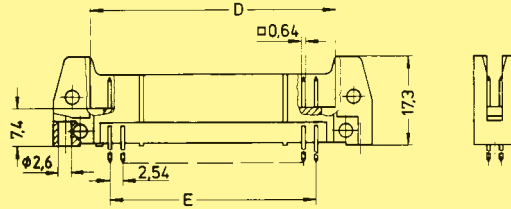

No. 1 contact

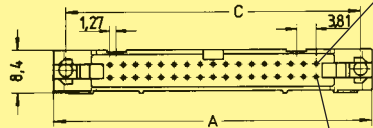

Long levers

for use with female connector with strain relief clamp

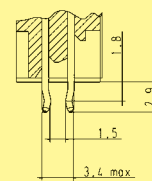

No. 2 contact

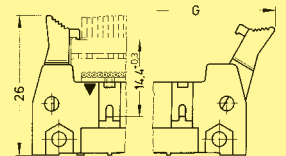
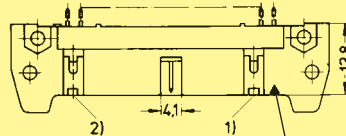

Marking No. 1 contact

No. 1 contact

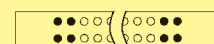
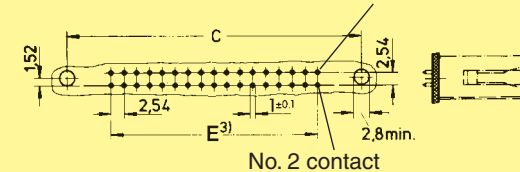

Board drillings

● Kinked contact: pcb thickness from 1.50 to 1.94 mm after Cu + Sn plating with non-remelted through holes \varnothing 0.80 to \varnothing 0.95 mm. Max. insertion force = 125 N. Min. retention force = 6 N.

○ Non-kinked contact: Solder pins for pcb connections \varnothing 1 ± 0.1 mm as per IEC 60603-13.

¹⁾ No polarization slot for 6, 10 or 14 way male header

²⁾ No polarization slot for 6 way male header

³⁾ Pitch tolerance: ± 0.1

Number of contacts

6-64



Male header with angled solder pins and board lock

Identification	No. of contacts	Part No.					
		Without levers		With short levers		With long levers	
<p>Male header with angled solder pins and pcb board lock</p> <p>Length: 2.9 mm for 1.6 mm pcb thickness</p> <p>To hold the connector on the pcb before the soldering process, two board locks have been added on the male header with angled solder pins.</p>	6	09 18 506	└ 973*	09 18 506	└ 963*	09 18 506	└ 953*
	10	09 18 510	└ 973*	09 18 510	└ 963*	09 18 510	└ 953*
	14	09 18 514	└ 973*	09 18 514	└ 963*	09 18 514	└ 953*
	16	09 18 516	└ 973*	09 18 516	└ 963*	09 18 516	└ 953*
	20	09 18 520	└ 973*	09 18 520	└ 963*	09 18 520	└ 953*
	26	09 18 526	└ 973*	09 18 526	└ 963*	09 18 526	└ 953*
	34	09 18 534	└ 973*	09 18 534	└ 963*	09 18 534	└ 953*
	40	09 18 540	└ 973*	09 18 540	└ 963*	09 18 540	└ 953*
	50	09 18 550	└ 973*	09 18 550	└ 963*	09 18 550	└ 953*
	60	09 18 560	└ 973*	09 18 560	└ 963*	09 18 560	└ 953*
	64	09 18 564	└ 973*	09 18 564	└ 963*	09 18 564	└ 953*

SEK

09-12

* Not normally kept in stock
30 contacts on request

For performance level 3 please specify digit
For performance level 2 please specify digit
> 0.76 µm Au (30 µinch) on request

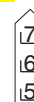
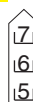

Number of contacts

6-64

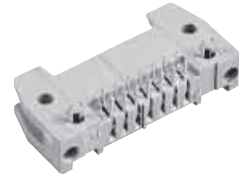

Male header with angled solder pins and board lock

Identification

Drawing

Dimensions in mm

Male header

No. of contacts	A	B	D	E	F	G
6	26.9	16.76	12.45	2.54 x 2 = 5.08	36.9	40.3
10	32.0	21.84	17.53	2.54 x 4 = 10.16	42.0	45.4
14	37.1	26.92	22.61	2.54 x 6 = 15.24	47.1	50.4
16	39.6	29.46	25.15	2.54 x 7 = 17.78	49.6	53.0
20	44.7	34.54	30.23	2.54 x 9 = 22.86	54.7	58.1
26	52.3	42.16	37.85	2.54 x 12 = 30.48	62.3	65.7
34	62.5	52.32	48.01	2.54 x 16 = 40.64	72.5	75.8
40	70.1	59.94	55.63	2.54 x 19 = 48.26	80.1	83.5
50	82.8	72.64	68.33	2.54 x 24 = 60.96	92.8	96.2
60	95.5	85.34	81.03	2.54 x 29 = 73.66	105.5	108.9
64	100.6	90.42	86.11	2.54 x 31 = 78.74	110.6	113.9

Short levers

for use with female connector without strain relief clamp

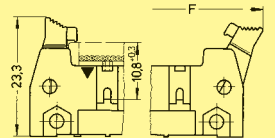

Long levers

for use with female connector with strain relief clamp

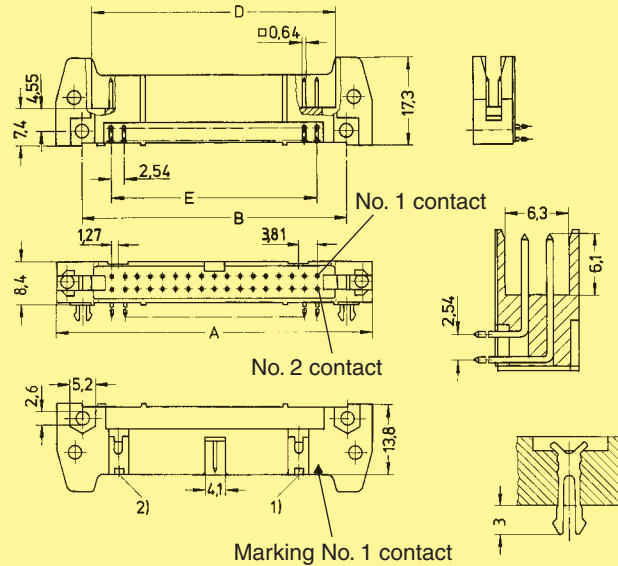
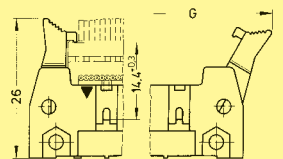

Board drillings

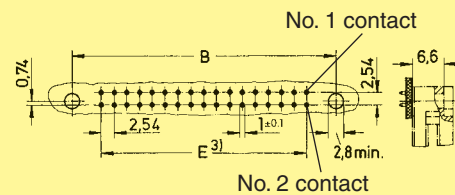

For accessories see page 09.16

¹⁾ No polarization slot for 6, 10 or 14 way male header

²⁾ No polarization slot for 6 way male header

³⁾ Pitch tolerance: ± 0.1

Number of contacts

6-64

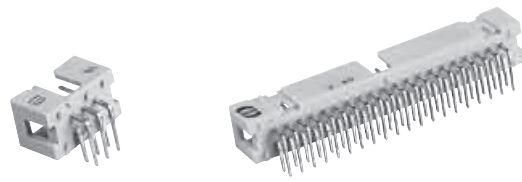

Low-profile male header, angled solder pins

Identification No. of contacts Part No. Drawing Dimensions in mm

Male header with angled solder pins

Length: 2.9 mm

6	09 18 506	□ 323
10	09 18 510	□ 323
14	09 18 514	□ 323
16	09 18 516	□ 323
20	09 18 520	□ 323
26	09 18 526	□ 323
34	09 18 534	□ 323
40	09 18 540	□ 323
50	09 18 550	□ 323
60	09 18 560	□ 323
64	09 18 564	□ 323

No. of contacts	A	B	E
6	15.2	12.78	2.54 x 2 = 5.08
10	20.3	17.86	2.54 x 4 = 10.16
14	25.4	22.94	2.54 x 6 = 15.24
16	27.9	25.48	2.54 x 7 = 17.78
20	33.0	30.56	2.54 x 9 = 22.86
26	40.6	38.18	2.54 x 12 = 30.48
34	50.8	48.34	2.54 x 16 = 40.64
40	58.4	55.96	2.54 x 19 = 48.26
50	71.3	68.66	2.54 x 24 = 60.96
60	84.0	81.36	2.54 x 29 = 73.66
64	89.1	86.44	2.54 x 31 = 78.74

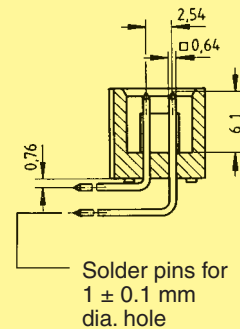

Marking No. 1 contact

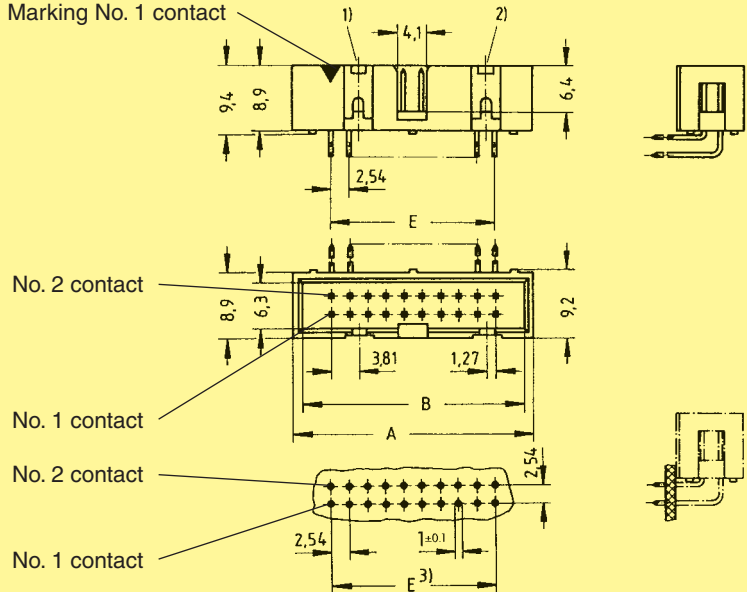

For performance level 3 please specify digit
For performance level 2 please specify digit
> 0.76 µm Au (30 µinch) on request

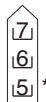

Identification No. of contacts Part No. Drawing Dimensions in mm

Locking lever for female connector with strain relief in conjunction with low-profile male header

When the security of latching is required and space is a premium, these locking levers can be fitted onto the strain relief of the HARTING female connector.

09 18 000 9905⁴⁾

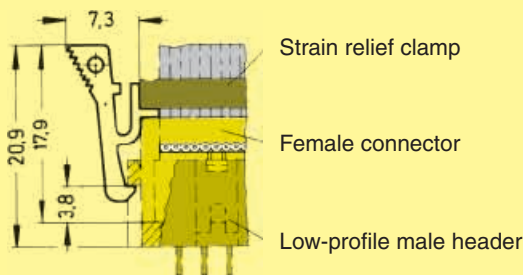

* Not normally kept in stock

¹⁾ No polarization slot for 6, 10 or 14 way male header
²⁾ No polarization slot for 6 way male header

³⁾ Pitch tolerance: ± 0.1
⁴⁾ Order 2 per female connector

Number of contacts

6-64



Low-profile male header, straight solder pins

Identification No. of contacts Part No. Drawing Dimensions in mm

Male header with straight solder pins
Length: 2.9 mm

6	09 18 506	└ 324
10	09 18 510	└ 324
14	09 18 514	└ 324
16	09 18 516	└ 324
20	09 18 520	└ 324
26	09 18 526	└ 324
34	09 18 534	└ 324
40	09 18 540	└ 324
50	09 18 550	└ 324
60	09 18 560	└ 324
64	09 18 564	└ 324

No. of contacts	A	B	E
6	15.2	12.78	2.54 x 2 = 5.08
10	20.3	17.86	2.54 x 4 = 10.16
14	25.4	22.94	2.54 x 6 = 15.24
16	27.9	25.48	2.54 x 7 = 17.78
20	33.0	30.56	2.54 x 9 = 22.86
26	40.6	38.18	2.54 x 12 = 30.48
34	50.8	48.34	2.54 x 16 = 40.64
40	58.4	55.96	2.54 x 19 = 48.26
50	71.3	68.66	2.54 x 24 = 60.96
60	84.0	81.36	2.54 x 29 = 73.66
64	89.1	86.44	2.54 x 31 = 78.74

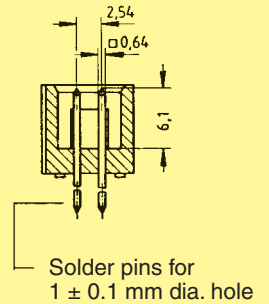

Male header with straight solder pins
Length: 4.5 mm

6	09 18 506	└ 322*
10	09 18 510	└ 322*
14	09 18 514	└ 322*
16	09 18 516	└ 322*
20	09 18 520	└ 322*
26	09 18 526	└ 322*
34	09 18 534	└ 322*
40	09 18 540	└ 322*
50	09 18 550	└ 322*
60	09 18 560	└ 322*
64	09 18 564	└ 322*

Marking No. 1 contact

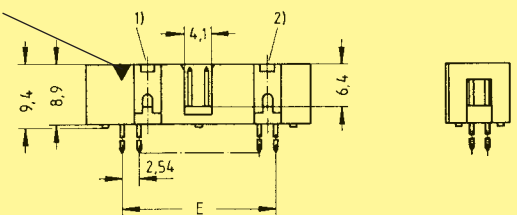

No. 2 contact

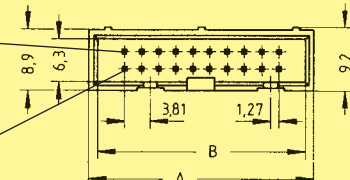

No. 1 contact

No. 2 contact

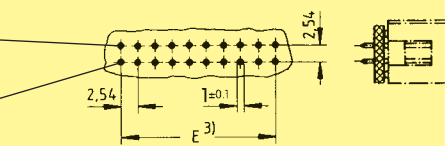

No. 1 contact

For performance level 3 please specify digit 7
For performance level 2 please specify digit 6
> 0.76 µm Au (30 µinch) on request



Identification No. of contacts Part No. Drawing Dimensions in mm

Locking lever for female connector with strain relief in conjunction with low-profile male header

When the security of latching is required and space is a premium, these locking levers can be fitted onto the strain relief of the HARTING female connector.

09 18 000 9905⁴⁾

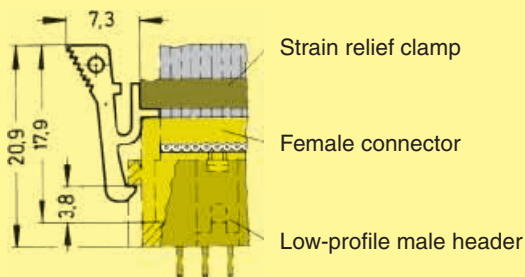

* Not normally kept in stock

¹⁾ No polarization slot for 6, 10 or 14 way male header
²⁾ No polarization slot for 6 way male header

³⁾ Pitch tolerance: ± 0.1
⁴⁾ Order 2 per female connector

Accessories

Identification	Part No.	Drawing	Dimensions in mm
<p>Polarization key</p> <p>1) Part No. comprises 2 keys</p>	<p>09 18 500 9902¹⁾</p>		
<p>Locking lever (snaps into place, can be fitted whenever required)</p> <p>2) Order 2 per male header</p>	<p>Long: 09 18 000 9903²⁾</p> <p>Short: 09 18 000 9904²⁾</p>	<p>Long</p> <p>Short</p> <p>For use with female connector <u>with</u> strain relief clamp</p> <p>For use with female connector <u>without</u> strain relief clamp</p>	
<p>Fixing screws for 1.6 mm P.C. board</p> <p>3) Part No. comprises 50 pieces</p>	<p>09 18 000 9906³⁾</p>		
<p>Coding system with loss of contact</p> <p>4) Part No. comprises 6 code pins</p>	<p>Code pin 09 18 000 9901⁴⁾</p> <p>Removal tool for male contacts 09 99 000 0133</p>	<p>To avoid cross-plugging adjacent connectors a coding system is required. A code pin is inserted into the appropriate cavity in the female connector. The corresponding male contact is removed by a special removal tool.</p>	

SEK

Number of contacts	6, 10, 14, 16, 20, 26, 34, 40, 50, 60, 64
Contact arrangement	straight, angled
Contact length	15 mm
Approvals	IEC 60603-13 DIN EN 60603-13 D 2632 BT 224 NFC 93-428 (HE 10) comply with MIL DTL 83503
Pitch	2.54 mm [0.100"]
Working current	1 A
Working voltage	500 V for pollution degree 1
Test voltage $U_{r.m.s.}$	1 kV
Contact resistance	$\leq 20 \text{ m}\Omega$
Insulation resistance	$\geq 10^9 \Omega$
Temperature range	-55 °C ... + 125 °C The maximum temperature includes heating of contacts and ambient temperature
Terminations	0.6 mm x 0.6 mm Diagonal: 0.86 mm
Materials Moulding	Thermoplastic resin (PBTP) UL 94-V0
Contact surface Contact zone	gold-plated according to performance level ¹⁾

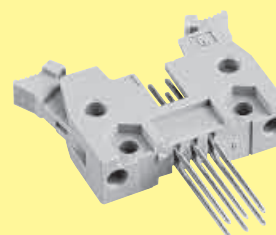
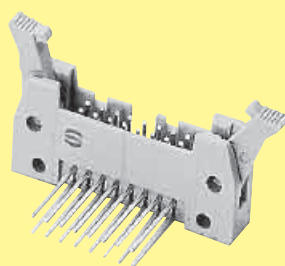

¹⁾ Performance level 3 as per IEC 60603-13, ≥ 50 mating cycles, no gas test
Performance level 2 as per IEC 60603-13, ≥ 250 mating cycles, 4 days gas test
as per MIL DTL 83503, $> 0.76 \mu\text{m Au}$ (30 μ inch), other performance levels on request

Number of contacts

6-64

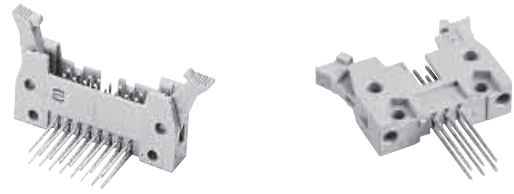

Male header with wrap posts

Identification	No. of contacts	Part No.						
		Without levers		With short levers		With long levers		
Male header with angled wrap posts Length: 15 mm □ 0.6 mm	6	09 18 506	└ 926*	09 18 506	└ 916*	09 18 506	└ 906*	
	10	09 18 510	└ 926*	09 18 510	└ 916*	09 18 510	└ 906*	
	14	09 18 514	└ 926*	09 18 514	└ 916*	09 18 514	└ 906*	
	16	09 18 516	└ 926*	09 18 516	└ 916*	09 18 516	└ 906*	
	20	09 18 520	└ 926*	09 18 520	└ 916*	09 18 520	└ 906*	
	26	09 18 526	└ 926*	09 18 526	└ 916*	09 18 526	└ 906*	
	34	09 18 534	└ 926*	09 18 534	└ 916*	09 18 534	└ 906*	
	40	09 18 540	└ 926*	09 18 540	└ 916*	09 18 540	└ 906*	
	50	09 18 550	└ 926*	09 18 550	└ 916*	09 18 550	└ 906*	
	60	09 18 560	└ 926*	09 18 560	└ 916*	09 18 560	└ 906*	
	64	09 18 564	└ 926*	09 18 564	└ 916*	09 18 564	└ 906*	
	Male header with straight wrap posts Length: 15 mm □ 0.6 mm	6	09 18 506	└ 927*	09 18 506	└ 917*	09 18 506	└ 907*
		10	09 18 510	└ 927*	09 18 510	└ 917*	09 18 510	└ 907*
14		09 18 514	└ 927*	09 18 514	└ 917*	09 18 514	└ 907*	
16		09 18 516	└ 927*	09 18 516	└ 917*	09 18 516	└ 907*	
20		09 18 520	└ 927*	09 18 520	└ 917*	09 18 520	└ 907*	
26		09 18 526	└ 927*	09 18 526	└ 917*	09 18 526	└ 907*	
34		09 18 534	└ 927*	09 18 534	└ 917*	09 18 534	└ 907*	
40		09 18 540	└ 927*	09 18 540	└ 917*	09 18 540	└ 907*	
50		09 18 550	└ 927*	09 18 550	└ 917*	09 18 550	└ 907*	
60		09 18 560	└ 927*	09 18 560	└ 917*	09 18 560	└ 907*	
64		09 18 564	└ 927*	09 18 564	└ 917*	09 18 564	└ 907*	

SEK

09-18

* Not normally kept in stock
 For accessories see page 09.20
 For dimensions see page 09.19

For performance level 3 please specify digit
 For performance level 2 please specify digit
 > 0.76 µm Au (30 µinch) on request

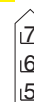
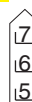

Accessories

Identification	Part No.	Drawing	Dimensions in mm
<p>Polarization key</p> <p>1) Part No. comprises 2 keys</p>	<p>09 18 500 9902¹⁾</p>		
<p>Locking lever (snaps into place, can be fitted whenever required)</p> <p>2) Order 2 per male header</p>	<p>Long: 09 18 000 9903²⁾</p> <p>Short: 09 18 000 9904²⁾</p>	<p>Long</p> <p>Short</p> <p>For use with female connector <u>with</u> strain relief clamp</p> <p>For use with female connector <u>without</u> strain relief clamp</p>	
<p>Fixing screws for 1.6 mm P.C. board</p> <p>3) Part No. comprises 50 pieces</p>	<p>09 18 000 9906³⁾</p>		
<p>Coding system with loss of contact</p> <p>4) Part No. comprises 6 code pins</p>	<p>Code pin 09 18 000 9901⁴⁾</p> <p>Removal tool for male contacts 09 99 000 0133</p>	<p>To avoid cross-plugging adjacent connectors a coding system is required. A code pin is inserted into the appropriate cavity in the female connector. The corresponding male contact is removed by a special removal tool.</p>	

SEK

Number of contacts 6, 10, 14, 16, 20, 26, 30*, 34, 40, 50, 60, 64

Approvals IEC 60 603-13
DIN EN 60 603-13
D 2632
BT 224
NFC 93-428 (HE 10)

UL recognized: E102079
comply with MIL DTL 83 503



Pitch 2.54 mm [0.100"]

Working current 1 A

Working voltage 320 V
for pollution degree 1

Test voltage $U_{r.m.s.}$ 1 kV

Contact resistance $\leq 20 \text{ m}\Omega$
Insulation resistance $\geq 10^9 \Omega$

Temperature range -55 °C ... + 125 °C
The maximum temperature includes heating of contacts and ambient temperature

Terminations IDC flat cable
1.27 mm [0.050"] pitch:
AWG 26/7 – AWG 28/7

Materials Moulding Thermoplastic resin (PBTP)
UL 94-V0

Contact surface Contact zone gold-plated according to performance level¹⁾

Current carrying capacity

The current carrying capacity is limited by maximum temperature of materials for inserts and contacts including terminals. The current capacity-curve is valid for continuous, not interrupted current-loaded contacts of connectors when simultaneous power on all contacts is given, without exceeding the maximum temperature.

Control and test procedures according to DIN IEC 60 512.

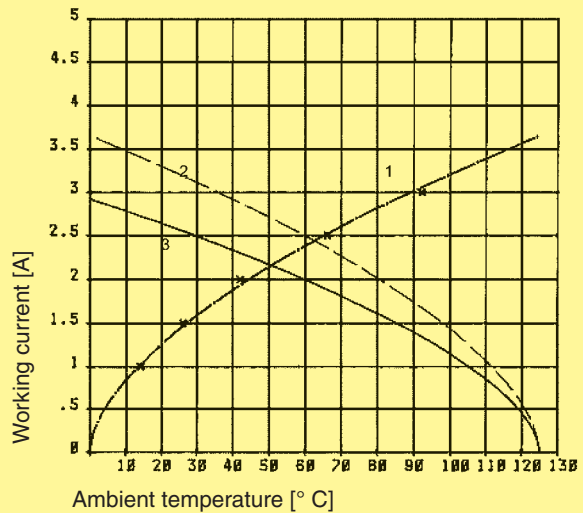

Example: 50 way connector

- ① Temperature rise
- ② Derating
- ③ Derating curve at $I_{max} \times 0.8$ (IEC 60512-2)

Insertion and withdrawal forces

Number of contacts	Maximum force [N]	
	Performance level 1 and 2	Performance level 3
6	12	18
10	20	30
14	28	42
16	32	48
20	40	60
26	52	78
30	60	90
34	68	102
40	80	120
50	100	150
60	120	180
64	128	192

¹⁾ Performance level 3 as per IEC 60 603-13, ≥ 50 mating cycles, no gas test
Performance level 2 as per IEC 60 603-13, ≥ 250 mating cycles, 4 days gas test
as per MIL DTL 83 503, $> 0.76 \mu\text{m Au}$ (30 μ inch), other performance levels on request

* on request

Number of contacts

6-64



Strain relief clamp/Locking lever

Identification	No. of contacts	Part No.	Drawing	Dimensions in mm
----------------	-----------------	----------	---------	------------------

Strain relief clamp

6	09 18 506 9002
10	09 18 510 9002
14	09 18 514 9002
16	09 18 516 9002
20	09 18 520 9002
26	09 18 526 9002
34	09 18 534 9002
40	09 18 540 9002
50	09 18 550 9002
60	09 18 560 9002
64	09 18 564 9002

No. of contacts	A
6	12.2
10	17.3
14	22.4
16	24.9
20	30.0
26	37.6
34	47.8
40	55.4
50	68.1
60	80.8
64	85.9

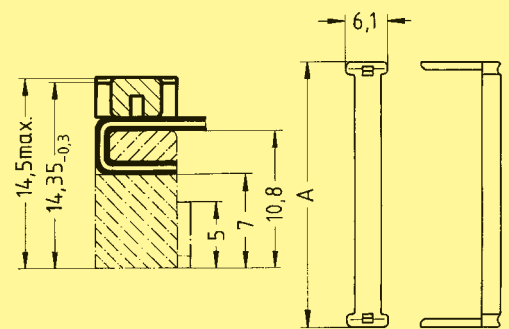

with bulk packaging

6	09 18 506 9002 58U ²⁾
10	09 18 510 9002 58U ²⁾
14	09 18 514 9002 58U ²⁾
16	09 18 516 9002 58U ²⁾
20	09 18 520 9002 58U ²⁾
26	09 18 526 9002 58U ²⁾
34	09 18 534 9002 58U ³⁾
40	09 18 540 9002 58U ³⁾

6	12.2
10	17.3
14	22.4
16	24.9
20	30.0
26	37.6
34	47.8
40	55.4

- ²⁾ Packaging unit 5,000 pieces
- ³⁾ Packaging unit 3,000 pieces

30 contacts on request

Locking lever for female connector
Only in conjunction with low-profile male header and strain relief

09 18 000 9905¹⁾

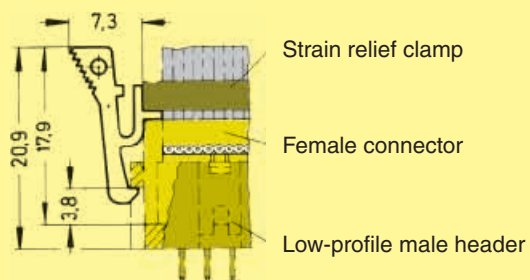

When the security of latching is required and space is a premium, these locking levers can be fitted onto the strain relief of the HARTING female connector. This can then be used in conjunction with male low-profile headers (see pages 09.14 and 09.15).

Coding system with loss of contact

Code pin

09 18 000 9901²⁾

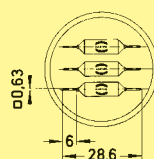

To avoid cross-plugging adjacent connectors a coding system is required. A code pin is inserted into the appropriate cavity in the female connector. The corresponding male contact is removed by a special removal tool.

Removal tool for male contacts

09 99 000 0133



¹⁾ Order 2 per female connector
²⁾ Part No. comprises 6 code pins

Number of contacts	6, 8, 10, 14, 16, 20, 24, 26, 30, 34, 40, 50, 60, 64
Pitch	On pcb side: 2.54 mm [0.100"] On cable side: 1.27 mm [0.050"]
Working current	1 A
Test voltage $U_{r.m.s.}$	1 kV AC – 1 minute
Contact resistance Insulation resistance	35 m Ω max. $\geq 10^9 \Omega$
Temperature range	-55 °C ... + 105 °C The maximum temperature includes heating of contacts and ambient temperature
Terminations	Solder pins: 0.635 mm x 0.3 mm Dimensions for pcb hole: Standard version: $\varnothing 0.9^{\pm 0.10}$ mm Kinked version: $\varnothing 1.0^{\pm 0.05}$ mm Diagonal: 0.71 mm IDC flat cable 1.27 mm [0.050"] pitch: AWG 28/7
Materials Moulding	Thermoplastic resin (PBT) UL 94-V0

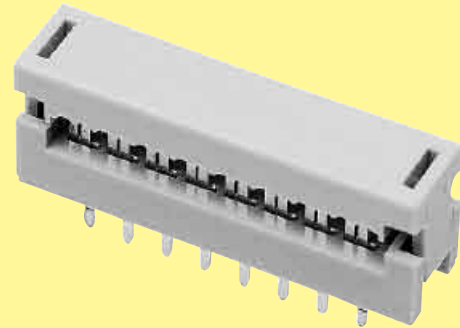
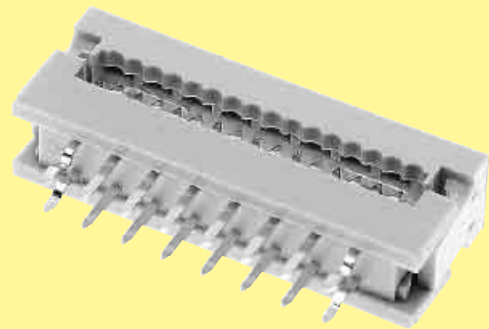

Number of contacts

6-40

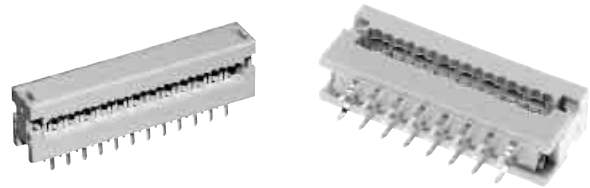

Pcb transition connector, 2 rows, low-profile with 5.5 mm height

Identification No. of contacts Part No. Drawing Dimensions in mm

Pcb transition connector
2 rows
Standard low-profile version

6	09 18 106 9622
8	09 18 108 9622
10	09 18 110 9622
14	09 18 114 9622
16	09 18 116 9622
20	09 18 120 9622
24	09 18 124 9622
26	09 18 126 9622
30	09 18 130 9622
34	09 18 134 9622
40	09 18 140 9622
50	09 18 150 9622
60	09 18 160 9622
64	09 18 164 9622

No. of contacts	A±0.38	B±0.10
6	12.92	2.54 x 2 = 5.08
8	15.46	2.54 x 3 = 7.62
10	18.00	2.54 x 4 = 10.16
14	23.08	2.54 x 6 = 15.24
16	25.62	2.54 x 7 = 17.78
20	30.74	2.54 x 9 = 22.86
24	35.78	2.54 x 11 = 27.94
26	38.32	2.54 x 12 = 30.48
30	43.40	2.54 x 14 = 35.56
34	48.48	2.54 x 16 = 40.64
40	56.10	2.54 x 19 = 48.26
50	68.80	2.54 x 24 = 60.96
60	81.50	2.54 x 29 = 73.66
64	86.58	2.54 x 31 = 78.74

Pcb transition connector
2 rows
Kinked low-profile version
2 kinked pins at each extremity

6	09 18 106 9422
8	09 18 108 9422
10	09 18 110 9422
14	09 18 114 9422
16	09 18 116 9422
20	09 18 120 9422
24	09 18 124 9422
26	09 18 126 9422
30	09 18 130 9422
34	09 18 134 9422
40	09 18 140 9422
50	09 18 150 9422
60	09 18 160 9422
64	09 18 164 9422

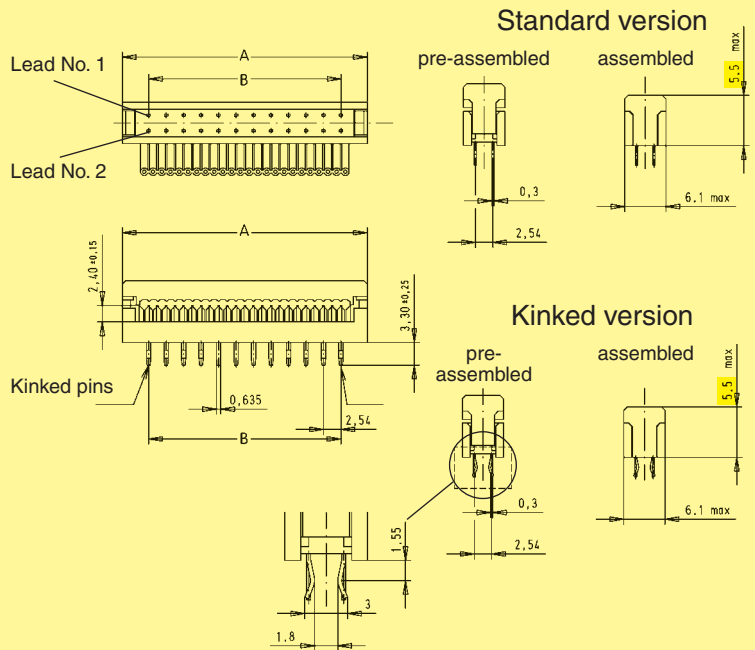

Board drillings

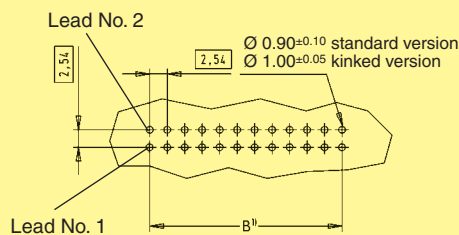

¹⁾ Pitch tolerance: ± 0.05

Number of contacts* 10, 16, 20, 26, 34, 40, 50

Pitch
On pcb side: 2.54 mm [0.100"]
On cable side: 1.27 mm [0.050"]

Working current 1 A

Test voltage $U_{r.m.s.}$ 500 V

Contact resistance $\leq 20 \text{ m}\Omega$
Insulation resistance $\geq 10^{12} \Omega$

Temperature range -40 °C ... + 125 °C
The maximum temperature includes heating of contacts and ambient temperature

Terminations
Solder pins
0.45 mm x 0.35 mm
for pcb hole \varnothing 0.8 mm
Diagonal: 0.58 mm
IDC flat cable
1.27 mm [0.050"] pitch:
AWG 26/7 – AWG 28/7 – AWG 30/1

Materials
Moulding Thermoplastic resin (PC)
UL 94-V0

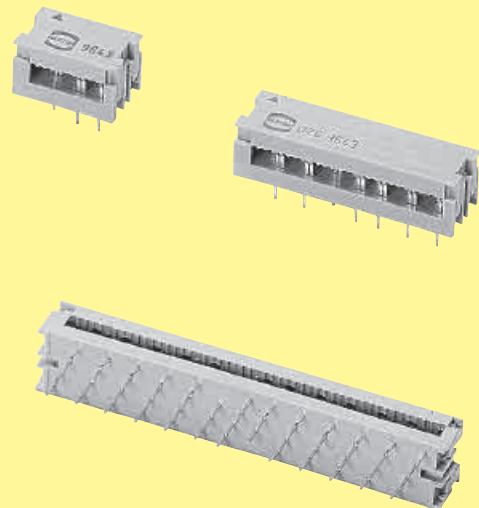

Number of contacts

10-50



Pcb transition connector, 4 rows

Identification No. of contacts Part No. Drawing Dimensions in mm

Pcb transition connector

4 rows

10	09 19 010 9643*
16	09 19 016 9643*
20	09 19 020 9643*
26	09 19 026 9643*
34	09 19 034 9643*
40	09 19 040 9643*
50	09 19 050 9643*

No. of contacts	A	B
10	17.78	1.27 x 9 = 11.43
16	25.40	1.27 x 15 = 19.05
20	30.48	1.27 x 19 = 24.13
26	38.10	1.27 x 25 = 31.75
34	48.26	1.27 x 33 = 41.91
40	55.88	1.27 x 39 = 49.53
50	68.58	1.27 x 49 = 62.23

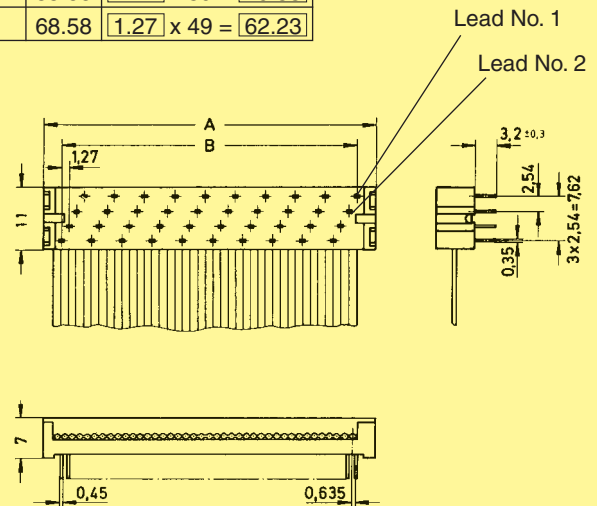

Board drillings

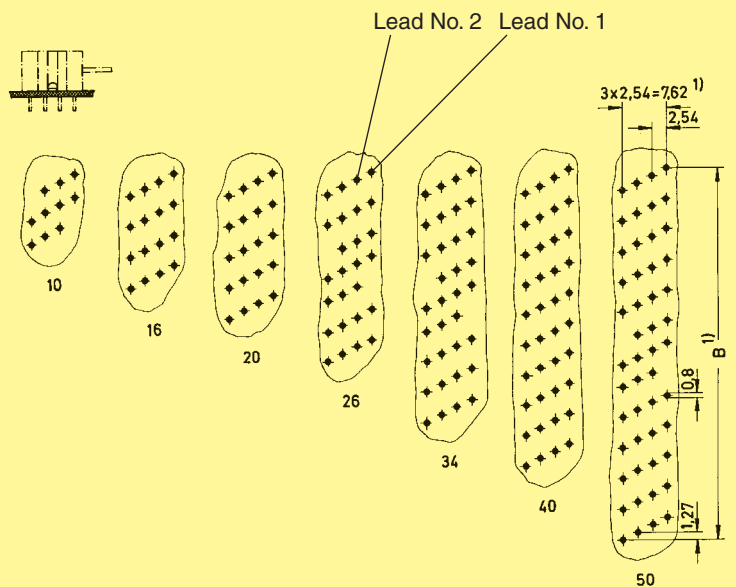

* Not normally kept in stock.
 1) Pitch tolerance: ± 0.1

SEK

Number of contacts*	14, 16, 24, 28, 40
Pitch	On pcb side: 2.54 mm [0.100"] On cable side: 1.27 mm [0.050"]
Working current	1 A
Test voltage $U_{r.m.s.}$	500 V
Contact resistance	$\leq 20 \text{ m}\Omega$
Insulation resistance	$\geq 10^{12} \Omega$
Temperature range	-40 °C ... + 125 °C The maximum temperature includes heating of contacts and ambient temperature
Terminations	Solder pins 0.45 mm x 0.35 mm for pcb hole \varnothing 0.8 mm Diagonal: 0.58 mm IDC flat cable 1.27 mm [0.050"] pitch: AWG 26/7 – AWG 28/7
Materials Moulding	Thermoplastic resin (PC) UL 94-V0

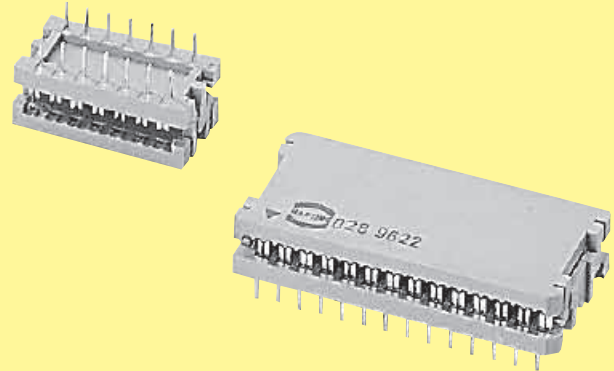

Number of contacts

14-40

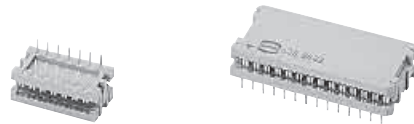

DIP connector for IC base or for soldering into pcb

Identification No. of contacts Part No. Drawing Dimensions in mm

DIP connector

14	09 17 014 9622*
16	09 17 016 9622*
24	09 17 024 9622*
28	09 17 028 9622*
40	09 17 040 9622*

No. of contacts	A	B	C	D
14	20.5	2.54 x 6 = 15.24	11	7.62
16	23.0	2.54 x 7 = 17.78	11	7.62
24	33.0	2.54 x 11 = 27.94	18.7	15.24
28	38.1	2.54 x 13 = 33.02	18.7	15.24
40	53.3	2.54 x 19 = 48.26	18.7	15.24

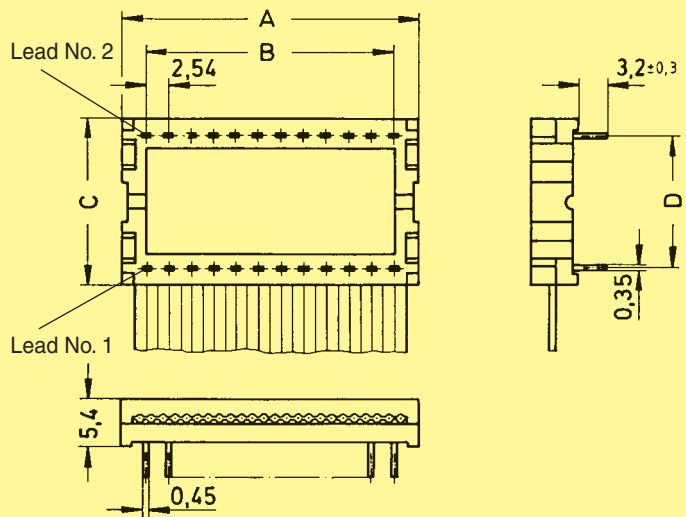

Board drillings

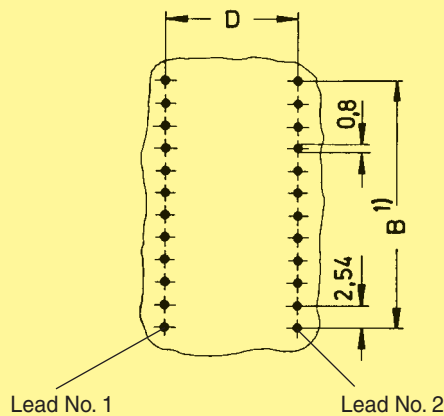
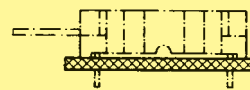

* Not normally kept in stock
 1) Pitch tolerance: ± 0.1

Number of contacts	64
Pitch	2.54 mm [0.100"]
Working current	1 A max.
Clearance Creepage	≥ 1.2 mm ≥ 1.2 mm
Working voltage	according to the safety regulations of the equipment
<p>The working voltage also depends on the clearance and creepage dimensions of the pcb itself, and the associated wiring</p>	
Test voltage $U_{r.m.s.}$	1 kV
Contact resistance	≤ 20 m Ω
Insulation resistance	$\geq 10^{12}$ Ω
Temperature range	-55 °C ... + 125 °C The maximum temperature includes heating of contacts and ambient temperature
Termination	
Female connector	Insulation displacement: AWG 28/7
Insertion and withdrawal force	≤ 60 N
Materials	
Moulding	Thermoplastic resin, glass-fibre filled, UL 94-V0
Contacts	Copper alloy
Contact surface	
Contact zone	selectively plated according to performance level

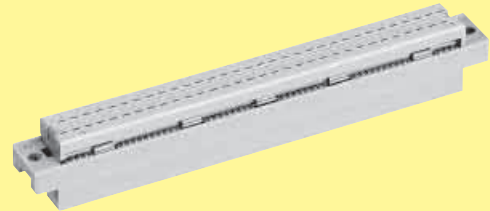
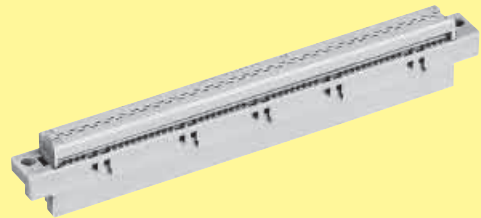

SEK

Number of contacts

64

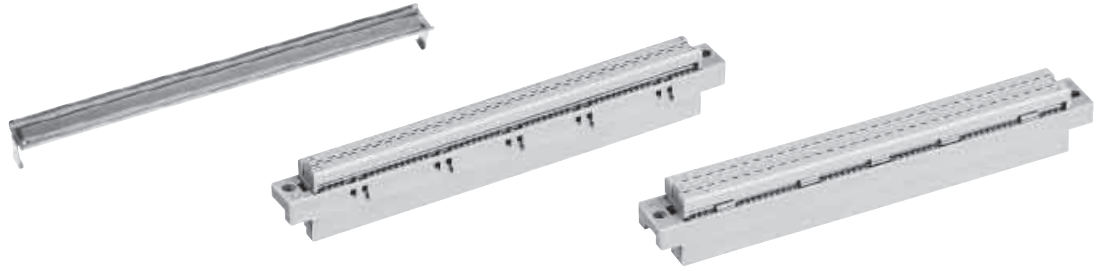

Female connectors for insulation displacement

Identification	No. of contacts	Part No.	Drawing	Dimensions in mm
----------------	-----------------	----------	---------	------------------

Female connector for insulation displacement

Type B

64

performance level 2

09 02 264 6828

performance level 3

09 02 264 7828

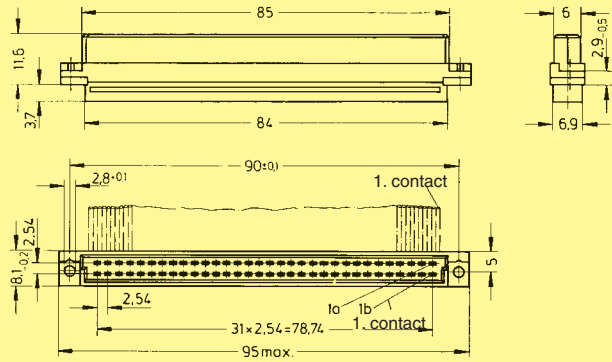

Lead number 1 of flat cable on contact 1 b

Contact arrangement View from termination side

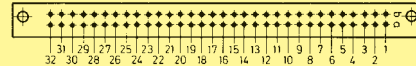

Type C

64

performance level 2

09 03 264 6828

09 03 764 6828^{c)}

performance level 3

09 03 264 7828

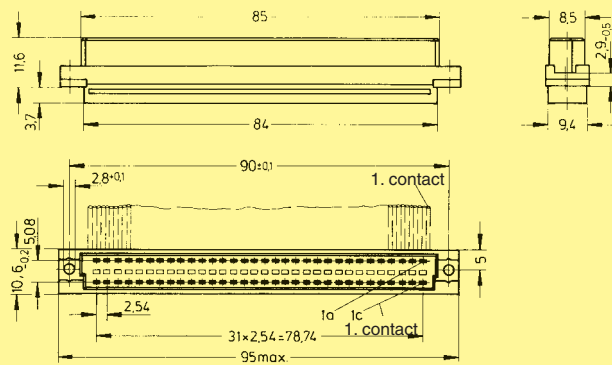

Lead number 1 of flat cable on contact 1 c

Contact arrangement View from termination side



Mateable with 3-row male connector Type C.
No female contact in middle row.

Panel cut out

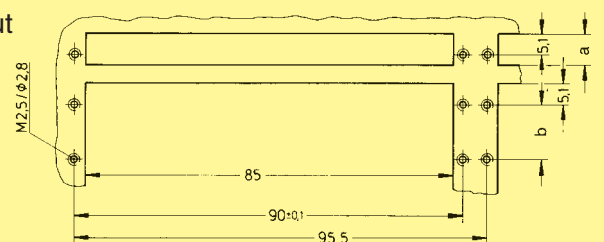

	a	b
Type B	8.3	10.16
Type C	10.8	12.7

Strain relief for types B and C

09 03 000 9940

SEK

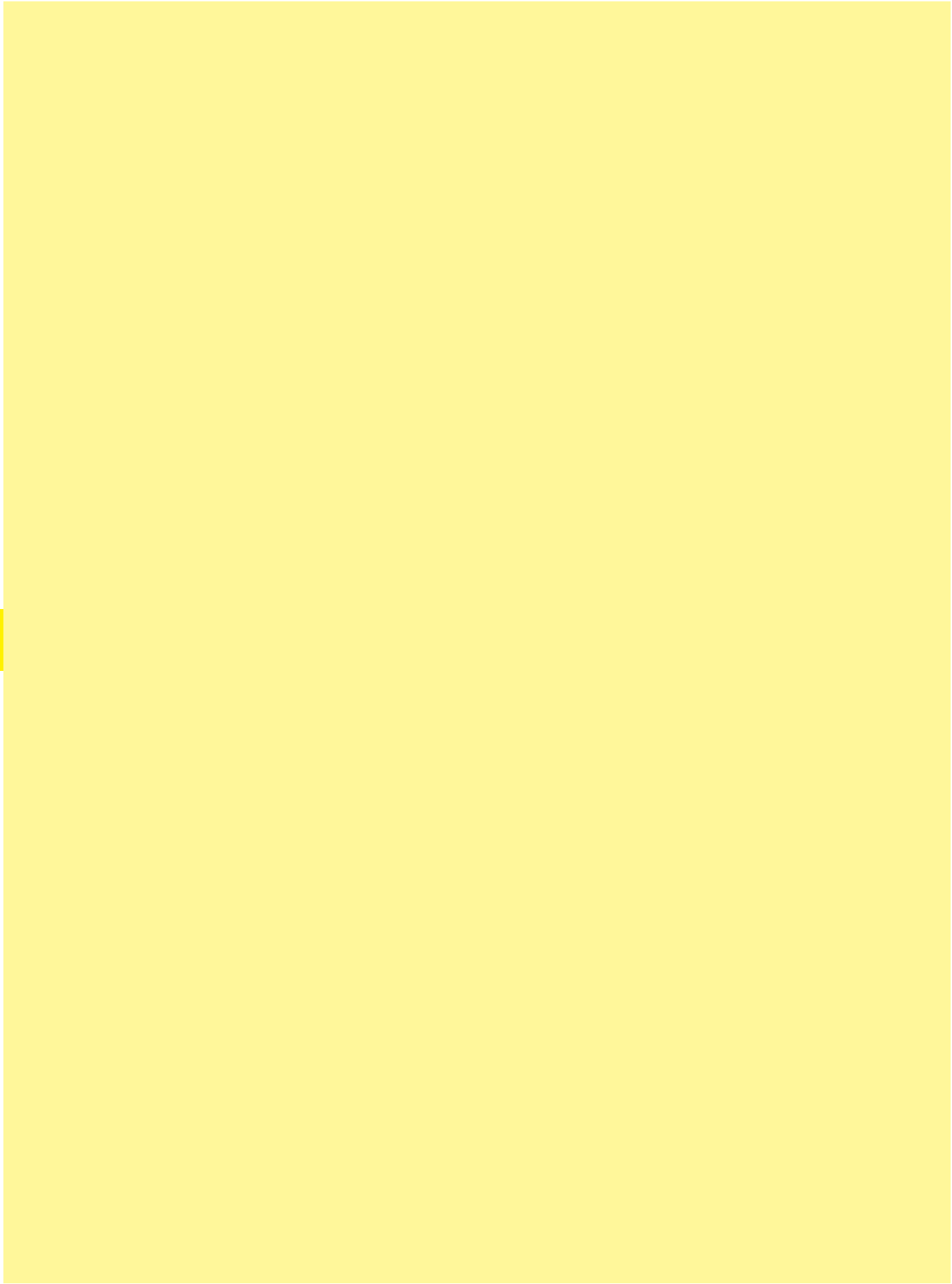

SEK