

Super Flux LEDs

Technical Data

SunPower Series

- HPWA-MH00 HPWT-MH00
- HPWA-DH00 HPWT-DH00
- HPWA-ML00 HPWT-ML00
- HPWA-DL00 HPWT-DL00
- HPWR-M300

Benefits

- Fewer LEDs Required
- Lowers Total System Cost

- Small and Large Area Displays
- Backlighting

Features

- High Flux Output
- Designed for High Current Operation
- Low Thermal Resistance
- Low Profile
- Meets SAE/ECE/JIS Automotive Color Requirements
- Packaged in Tubes for Use with Automatic Pick and Place Equipment

Description

This revolutionary package design allows the lighting designer to reduce the number of LEDs required and provide a more uniform and unique illuminated appearance than with existing LED solutions. This is possible through the package's efficient optical design and high-current capabilities. The low profile package can be easily coupled to reflectors or lenses to efficiently distribute light and provide the desired illuminated appearance.

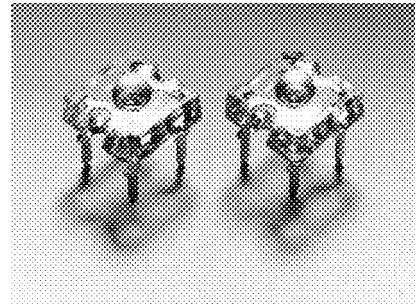

Applications

- Automotive Exterior Lighting
- Moving Message Panels

This product family employs red, red-orange, and amber LED

materials, which allow designers to match the color of popular lighting applications, such as automotive tail, stop, and turn signal lamps, and area displays. Included in this family is the world's brightest amber LED material, which is ideal for area displays and general backlighting applications.

Device Selection Guide

Part Number	LED Color	Total Flux ϕ_v (mlm) @ 70 mA ^[1] Typ.	Viewing Angle $2\theta^{1/2}$ (Degrees) Typ.
HPWR-M300	TS AlGaAs Red	800	90
HPWA-MH00	AS AlInGaP Red-Orange	1250	90
HPWA-DH00			60
HPWA-ML00	AS AlInGaP Amber	1250	90
HPWA-DL00			60
HPWT-MH00	TS AlInGaP Red-Orange	2500	70
HPWT-DH00			40
HPWT-ML00	TS AlInGaP Amber	2500	70
HPWT-DL00			40

Notes:

1. ϕ_v is the total luminous flux output as measured with an integrating sphere.
2. $\theta^{1/2}$ is the off axis angle from optical centerline where the luminous intensity is $1/2$ the on-axis value.

Outline Drawing

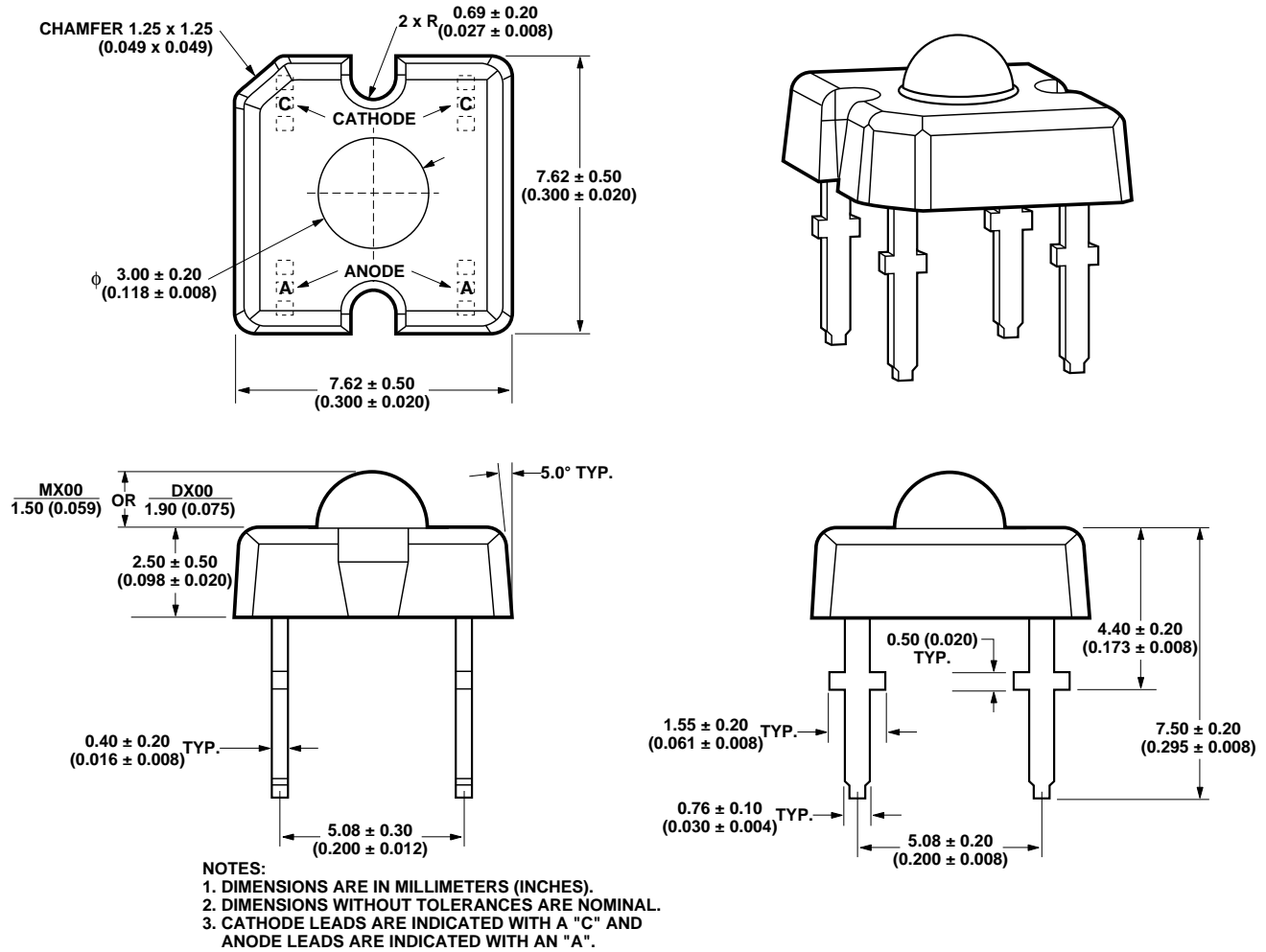

Absolute Maximum Ratings at $T_A = 25^\circ\text{C}$

Parameter	HPWR-M300	HPWA-MX00/DX00	HPWT-MX00/DX00	Units
DC Forward Current ^[1]	70	70 ^[2,3]	70 ^[2,3]	mA
Power Dissipation	161	147	193	mW
Reverse Voltage ($I_R = 100 \mu\text{A}$)	10	10	10	V
Operating Temperature Range	-40 to +100	-40 to +100	-40 to +100	$^\circ\text{C}$
Storage Temperature	-55 to +100	-55 to +100	-55 to +100	$^\circ\text{C}$
High Temperature Chamber	125 $^\circ\text{C}$, 2 hrs. max.			
LED Junction Temperature	125 $^\circ\text{C}$			
Solder Conditions				
Preheat Temperature	100 $^\circ\text{C}$			
Solder Temperature	260 $^\circ\text{C}$ for 5 seconds [1.5 mm (0.06 in.) below seating plane]			

Notes:

- Derate linearly as shown in Figure 4a and 4b.
- Drive Currents between 10 mA and 30 mA are recommended for best long term performance.
- Operation at currents below 10 mA is not recommended, please contact your Hewlett-Packard sales representative.

Optical Characteristics at $T_A = 25^\circ\text{C}$

Part Number	Total Flux ϕ_v (mIm) @ 70 mA ^[1]		Peak Wavelength λ_{peak} (nm) Typ.	Color, Dominant Wavelength λ_d (nm) ^[2] Typ.	Total Included Angle $\theta_{0.90V}$ (Degrees) ^[3] Typ.	Luminous Intensity/ Total Flux I_v (mcd)/ ϕ_v (mIm) Typ.
	Min.	Typ.				
HPWR-M300	500	800	655	643	95	0.7
HPWA-MH00	500	1250	621	615	95	0.6
HPWA-DH00					75	0.85
HPWA-ML00	500	1250	592	590	95	0.6
HPWA-DL00					75	0.85
HPWT-MH00	990	2500	626	617	100	0.6
HPWT-DH00					70	1.25
HPWT-ML00	990	2500	594	592	100	0.6
HPWT-DL00					70	1.25

Notes:

- ϕ_v is the total luminous flux output as measured with an integrating sphere.
- The dominant wavelength is derived from the CIE Chromaticity Diagram and represents the color of the device.
- $\theta_{0.90V}$ is the included angle at which 90% of the total luminous flux is captured.

Electrical Characteristics at $T_A = 25^\circ\text{C}$

Part Number	Forward Voltage V_F (Volts) @ $I_F = 70$ mA			Reverse Breakdown V_R (Volts) @ $I_R = 100$ μA		Capacitance C (pF) $V_F = 0$, $f = 1$ MHz Typ.	Thermal Resistance $R\theta_{J-PIN}$ ($^\circ\text{C}/\text{W}$) Typ.	Speed of Response τ_s (ns) ^[1] Typ.
	Min.	Typ.	Max.	Min.	Typ.			
HPWR-M300	2.01	2.25	2.75	10	20	20	155	45
HPWA-MH00/DH00	2.01	2.25	2.75	10	20	40	155	13
HPWA-ML00/DL00	2.01	2.25	2.75	10	20	40	155	13
HPWT-MH00/DH00	2.25	2.65	3.00	10	20	40	125	13
HPWT-ML00/DL00	2.25	2.65	3.00	10	20	40	125	13

Note:

- t_s is the time constant, e^{-t/τ_s} .

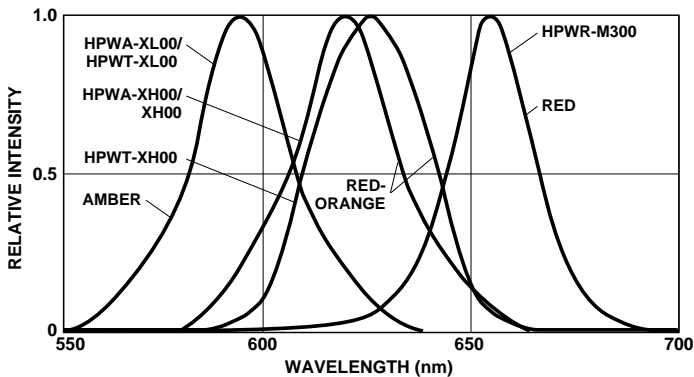

Figure 1. Relative Intensity vs. Wavelength.

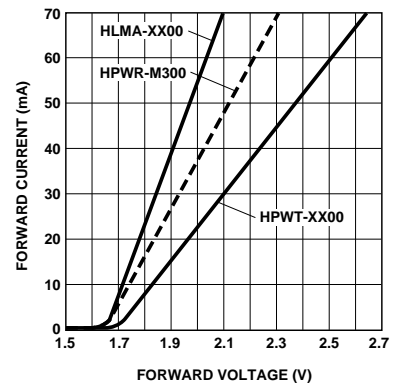

Figure 2. Forward Current vs. Forward Voltage.

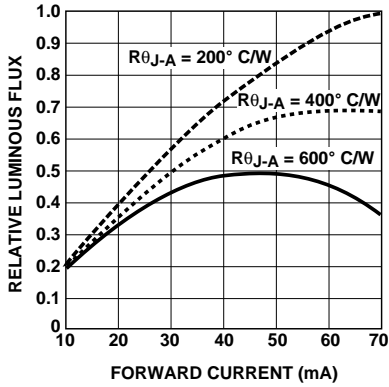

Figure 3a. HPWR-M300 Relative Luminous Flux vs. Forward Current.

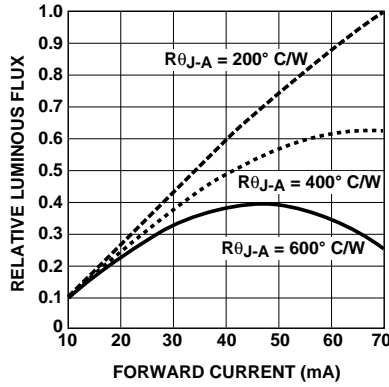

Figure 3b. HPWA/HPWT-XX00 Relative Luminous Flux vs. Forward Current.

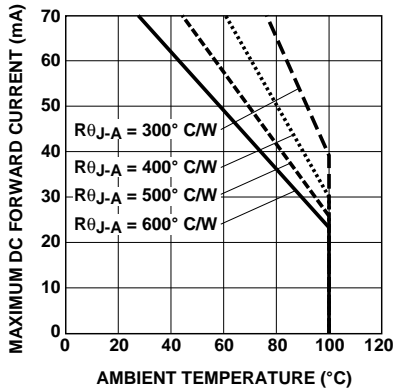

Figure 4a. HPWR-M300/HPWA-XX00 Maximum DC Forward Current vs. Ambient Temperature.

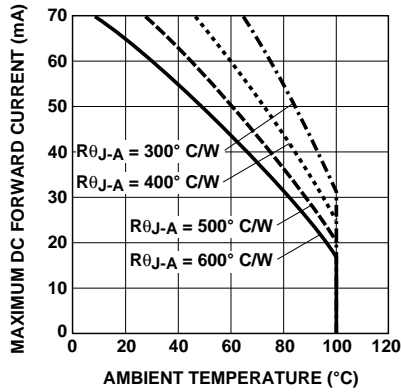

Figure 4b. HPWT-XX00 Maximum DC Forward Current vs. Ambient Temperature.

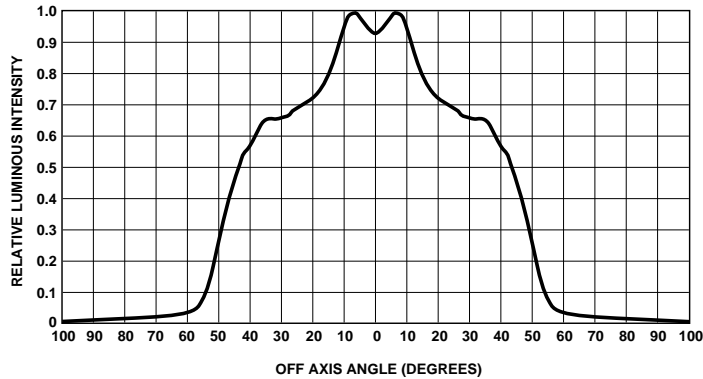

Figure 5a. HPWR-M300, HPWA-MX00 Relative Luminous Intensity vs. Off Axis Angle.

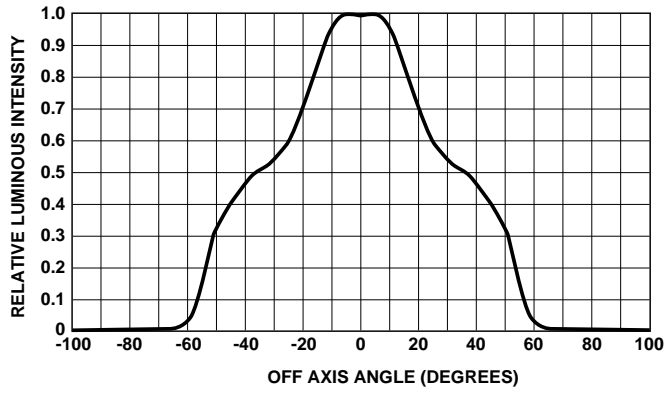

Figure 5b. HPWT-MX00 Relative Luminous Intensity vs. Off Axis Angle.

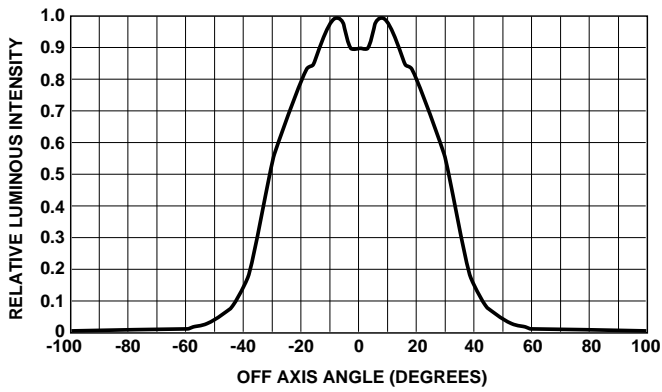

Figure 5c. HPWA-DX00 Relative Luminous Intensity vs. Off Axis Angle.

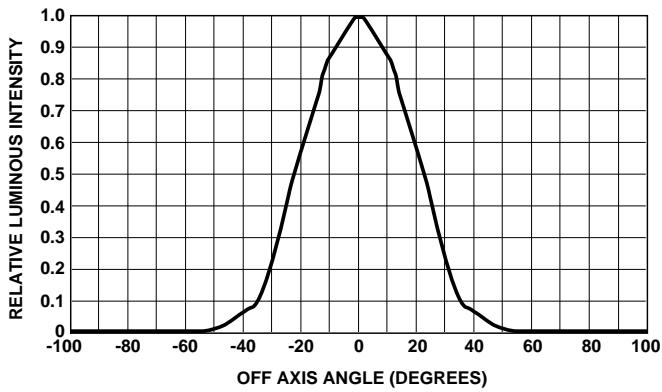

Figure 5d. HPWT-DX00 Relative Luminous Intensity vs. Off Axis Angle.

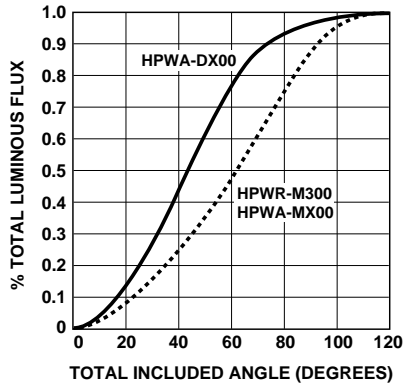

Figure 6a. HPWR-M300/HPWA-XX00 Percent Total Luminous Flux vs. Total Included Angle.

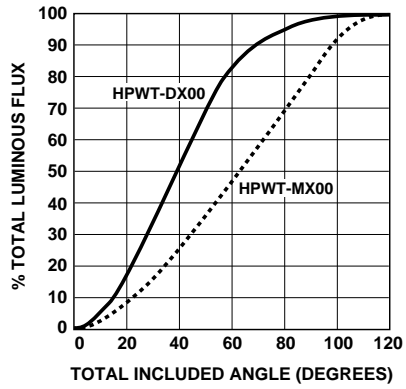

Figure 6b. HPWT-XX00 Percent Total Luminous Flux vs. Total Included Angle.