

Fully Sealed Relay with High Impulse Dielectric for Use in Telecommunications Equipment

- High sensitivity can be driven by digital circuits.
- Horizontal design allows use in 1/2-inch PCB racks.
- Impulse withstand voltage meets FCC Part 68 requirements.
- Relays can be mounted side-by-side due to low magnetic leakage.
- Single- and double-winding latching relays also available.
- Special models available for low thermoelectromotive force.

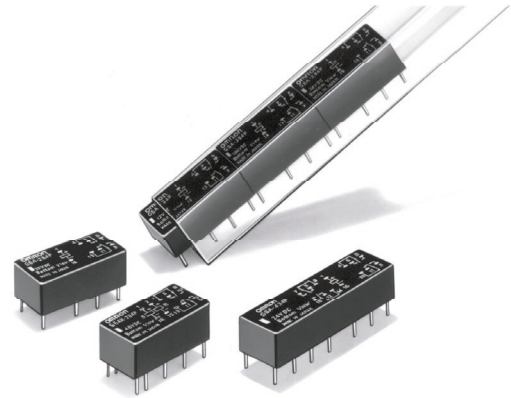

Ordering Information

Single-side Stable Type

| Contact | | Ag + Au-clad | AgPd + Au-clad |
|-----------------|------|------------------|------------------|
| General purpose | DPDT | G6A-274P-ST-US | G6A-234P-ST-US |
| | 4PDT | G6A-474P-ST-US | G6A-434P-ST-US |
| Low-sensitivity | DPDT | G6A-274P-ST40-US | G6A-234P-ST40-US |
| | 4PDT | G6A-474P-ST40-US | G6A-434P-ST40-US |

Single-winding Latching Type

| Contact | | Ag + Au-clad | AgPd + Au-clad |
|-----------------|------|-----------------|-----------------|
| General purpose | DPDT | G6AU-274P-ST-US | G6AU-234P-ST-US |
| | 4PDT | G6AU-474P-ST-US | G6AU-434P-ST-US |

Double-winding Latching Type

| Contact | | Ag + Au-clad | AgPd + Au-clad |
|-----------------|------|-------------------|-------------------|
| General purpose | DPDT | G6AK-274P-ST-US | G6AK-234P-ST-US |
| | 4PDT | G6AK-474P-ST-US | G6AK-434P-ST-US |
| Low-sensitivity | DPDT | G6AK-274P-ST40-US | G6AK-234P-ST40-US |
| | 4PDT | G6AK-474P-ST40-US | G6AK-434P-ST40-US |

Note: When ordering, add the rated coil voltage to the model number.
 Example: G6A-274P-ST-US 12 VDC

Rated coil voltage

Model Number Legend

G6A - - - VDC
 1 2 3 4 5 6 7 8 9

1. Relay Function

None: Single-side stable
 U: Single-winding latching
 K: Double-winding latching

2. Contact Form

2: DPDT
 4: 4PDT

3. Contact Type

7: Bifurcated crossbar
 Ag (Au-clad) contact
 3: Bifurcated crossbar
 AgPd (Au-clad) contact

4. Enclosure Ratings

4: Fully sealed

5. Terminals

P: Straight PCB

6. Stand-off

ST: Stand-off 0.64 mm

7. Special Function

40: Low-sensitivity (400 mW)
 LT: Low thermoelectromotive force

8. Approved Standards

US: UL, CSA certified

9. Rated Coil Voltage

3, 4.5, 5, 6, 9, 12, 24, 48 VDC

Specifications

■ Coil Ratings

General-purpose, DPDT Relays

| | | | | | | | | |
|----------------------------------|-------------------------------|---------|-------|---------|---------|---------|----------------|---------|
| Rated voltage | 3 VDC | 4.5 VDC | 5 VDC | 6 VDC | 9 VDC | 12 VDC | 24 VDC | 48 VDC |
| Rated current | 66.7 mA | 44.6 mA | 40 mA | 33.3 mA | 22.2 mA | 16.7 mA | 8.3 mA | 4.9 mA |
| Coil resistance | 45 Ω | 101 Ω | 125 Ω | 180 Ω | 405 Ω | 720 Ω | 2,880 Ω | 9,750 Ω |
| Coil inductance (H) (ref. value) | Armature OFF | 0.07 | 0.16 | 0.2 | 0.29 | 0.63 | 1.1 | 4.5 |
| | Armature ON | 0.065 | 0.14 | 0.18 | 0.26 | 0.57 | 1.06 | 4.1 |
| Must operate voltage | 70% max. of rated voltage | | | | | | | |
| Must release voltage | 10% min. of rated voltage | | | | | | | |
| Max. voltage | 200% of rated voltage at 23°C | | | | | | | |
| Power consumption | Approx. 200 mW | | | | | | Approx. 235 mW | |

General-purpose, 4PDT Relays

| | | | | | | | | |
|----------------------------------|-------------------------------|---------|---------|-------|-------|--------|---------|---------|
| Rated voltage | 3 VDC | 4.5 VDC | 5 VDC | 6 VDC | 9 VDC | 12 VDC | 24 VDC | 48 VDC |
| Rated current | 120 mA | 79.9 mA | 72.5 mA | 60 mA | 40 mA | 30 mA | 15 mA | 7.5 mA |
| Coil resistance | 25 Ω | 56.3 Ω | 69 Ω | 100 Ω | 225 Ω | 400 Ω | 1,600 Ω | 6,400 Ω |
| Coil inductance (H) (ref. value) | Armature OFF | 0.05 | 0.11 | 0.14 | 0.2 | 0.45 | 0.8 | 3.2 |
| | Armature ON | 0.045 | 0.095 | 0.12 | 0.17 | 0.38 | 0.68 | 2.7 |
| Must operate voltage | 70% max. of rated voltage | | | | | | | |
| Must release voltage | 10% min. of rated voltage | | | | | | | |
| Max. voltage | 150% of rated voltage at 23°C | | | | | | | |
| Power consumption | Approx. 360 mW | | | | | | | |

Low-sensitivity DPDT Relays

| | | | | | | | | |
|----------------------------------|-------------------------------|---------|--------|---------|---------|---------|---------|---------|
| Rated voltage | 3 VDC | 4.5 VDC | 5 VDC | 6 VDC | 9 VDC | 12 VDC | 24 VDC | 48 VDC |
| Rated current | 133.3 mA | 88.9 mA | 80 mA | 66.7 mA | 44.3 mA | 33.3 mA | 16.7 mA | 8.3 mA |
| Coil resistance | 22.5 Ω | 50.6 Ω | 62.5 Ω | 90 Ω | 203 Ω | 360 Ω | 1,440 Ω | 5,760 Ω |
| Coil inductance (H) (ref. value) | Armature OFF | 0.03 | 0.065 | 0.08 | 0.11 | 0.27 | 0.52 | 2.1 |
| | Armature ON | 0.02 | 0.06 | 0.07 | 0.1 | 0.23 | 0.43 | 1.8 |
| Must operate voltage | 70% max. of rated voltage | | | | | | | |
| Must release voltage | 10% min. of rated voltage | | | | | | | |
| Max. voltage | 150% of rated voltage at 23°C | | | | | | | |
| Power consumption | Approx. 400 mW | | | | | | | |

Low-sensitivity 4PDT Relays

| | | | | | | | | |
|----------------------------------|-------------------------------|---------|--------|---------|---------|---------|---------|---------|
| Rated voltage | 3 VDC | 4.5 VDC | 5 VDC | 6 VDC | 9 VDC | 12 VDC | 24 VDC | 48 VDC |
| Rated current | 133.3 mA | 88.9 mA | 80 mA | 66.7 mA | 44.3 mA | 33.3 mA | 16.7 mA | 8.3 mA |
| Coil resistance | 22.5 Ω | 50.6 Ω | 62.5 Ω | 90 Ω | 203 Ω | 360 Ω | 1,440 Ω | 5,760 Ω |
| Coil inductance (H) (ref. value) | Armature OFF | 0.035 | 0.1 | 0.12 | 0.17 | 0.42 | 0.7 | 2.8 |
| | Armature ON | 0.02 | 0.07 | 0.09 | 0.13 | 0.3 | 0.52 | 2.2 |
| Must operate voltage | 70% max. of rated voltage | | | | | | | |
| Must release voltage | 10% min. of rated voltage | | | | | | | |
| Max. voltage | 150% of rated voltage at 23°C | | | | | | | |
| Power consumption | Approx. 400 mW | | | | | | | |

Single-winding Latching, DPDT Relays

| | | | | | | | | | |
|----------------------------------|-------------------------------|---------|---------|-------|---------|---------|---------|----------------|----------|
| Rated voltage | | 3 VDC | 4.5 VDC | 5 VDC | 6 VDC | 9 VDC | 12 VDC | 24 VDC | 48 VDC |
| Rated current | | 33.7 mA | 22.2 mA | 20 mA | 16.7 mA | 11.1 mA | 8.3 mA | 4.2 mA | 2.5 mA |
| Coil resistance | | 89 Ω | 202 Ω | 250 Ω | 360 Ω | 810 Ω | 1,440 Ω | 5,760 Ω | 19,000 Ω |
| Coil inductance (H) (ref. value) | Armature OFF | 0.15 | 0.34 | 0.44 | 0.64 | 1.38 | 2.5 | 9.2 | 28.5 |
| | Armature ON | 0.11 | 0.25 | 0.35 | 0.48 | 1.07 | 2 | 7.2 | 22 |
| Must operate voltage | 70% max. of rated voltage | | | | | | | | |
| Must release voltage | 70% max. of rated voltage | | | | | | | | |
| Max. voltage | 200% of rated voltage at 23°C | | | | | | | | |
| Power consumption | Approx. 100 mW | | | | | | | Approx. 120 mW | |

Single-winding Latching, 4PDT Relays

| | | | | | | | | | |
|----------------------------------|-------------------------------|----------|---------|--------|---------|---------|---------|---------|---------|
| Rated voltage | | 3 VDC | 4.5 VDC | 5 VDC | 6 VDC | 9 VDC | 12 VDC | 24 VDC | 48 VDC |
| Rated current | | 106.8 mA | 71.2 mA | 64 mA | 53.3 mA | 35.6 mA | 26.7 mA | 13.3 mA | 6.7 mA |
| Coil resistance | | 28.1 Ω | 63.2 Ω | 78.1 Ω | 112.5 Ω | 253 Ω | 450 Ω | 1,800 Ω | 7,200 Ω |
| Coil inductance (H) (ref. value) | Armature OFF | 0.03 | 0.06 | 0.08 | 0.11 | 0.25 | 0.45 | 1.8 | 7 |
| | Armature ON | 0.02 | 0.04 | 0.06 | 0.08 | 0.18 | 0.32 | 1.3 | 5.2 |
| Must operate voltage | 70% max. of rated voltage | | | | | | | | |
| Must release voltage | 70% max. of rated voltage | | | | | | | | |
| Max. voltage | 150% of rated voltage at 23°C | | | | | | | | |
| Power consumption | Approx. 320 mW | | | | | | | | |

Double-winding Latching, DPDT Relays

| | | | | | | | | | | |
|----------------------------------|-------------------------------|----------------|---------|----------------|-------|-------|--------|---------|----------------|-----|
| Rated voltage | | 3 VDC | 4.5 VDC | 5 VDC | 6 VDC | 9 VDC | 12 VDC | 24 VDC | 48 VDC | |
| Rated current | | 66.7 mA | 40.2 mA | 36 mA | 30 mA | 20 mA | 15 mA | 7.5 mA | 4.2 mA | |
| Coil resistance | | 45 Ω | 112 Ω | 139 Ω | 200 Ω | 450 Ω | 800 Ω | 3,200 Ω | 11,520 Ω | |
| Coil inductance (H) (ref. value) | Set | Armature OFF | 0.037 | 0.09 | 0.11 | 0.16 | 0.38 | 0.6 | 2.1 | 8.5 |
| | | Armature ON | 0.027 | 0.065 | 0.08 | 0.12 | 0.28 | 0.45 | 1.5 | 6.3 |
| | Reset | Armature OFF | 0.027 | 0.065 | 0.08 | 0.12 | 0.28 | 0.45 | 1.5 | 6.3 |
| | | Armature ON | 0.037 | 0.09 | 0.11 | 0.16 | 0.38 | 0.6 | 2.1 | 8.5 |
| Must operate voltage | 70% max. of rated voltage | | | | | | | | | |
| Must release voltage | 70% max. of rated voltage | | | | | | | | | |
| Max. voltage | 200% of rated voltage at 23°C | | | | | | | | | |
| Power consumption | | Approx. 200 mW | | Approx. 180 mW | | | | | Approx. 200 mW | |

Double-winding Latching, 4PDT Relays

| | | | | | | | | | | |
|----------------------------------|-------------------------------|--------------|---------|--------|---------|---------|---------|---------|---------|-----|
| Rated voltage | | 3 VDC | 4.5 VDC | 5 VDC | 6 VDC | 9 VDC | 12 VDC | 24 VDC | 48 VDC | |
| Rated current | | 106.8 mA | 71.2 mA | 64 mA | 53.3 mA | 35.6 mA | 26.7 mA | 13.3 mA | 6.7 mA | |
| Coil resistance | | 28.1 Ω | 63.2 Ω | 78.1 Ω | 112.5 Ω | 253 Ω | 450 Ω | 1,800 Ω | 7,200 Ω | |
| Coil inductance (H) (ref. value) | Set | Armature OFF | 0.03 | 0.06 | 0.08 | 0.11 | 0.25 | 0.45 | 1.8 | 7 |
| | | Armature ON | 0.02 | 0.04 | 0.06 | 0.08 | 0.18 | 0.32 | 1.3 | 5.2 |
| | Reset | Armature OFF | 0.02 | 0.04 | 0.06 | 0.08 | 0.18 | 0.32 | 1.3 | 5.2 |
| | | Armature ON | 0.03 | 0.06 | 0.08 | 0.11 | 0.25 | 0.45 | 1.8 | 7 |
| Must operate voltage | 70% max. of rated voltage | | | | | | | | | |
| Must release voltage | 70% max. of rated voltage | | | | | | | | | |
| Max. voltage | 150% of rated voltage at 23°C | | | | | | | | | |
| Power consumption | Approx. 320 mW | | | | | | | | | |

Double-winding Latching, Low-sensitivity DPDT Relays

| | | | | | | | | | | |
|----------------------------------|-------|--------------|-------------------------------|---------|---------|-------|-------|--------|---------|---------|
| Rated voltage | | | 3 VDC | 4.5 VDC | 5 VDC | 6 VDC | 9 VDC | 12 VDC | 24 VDC | 48 VDC |
| Rated current | | | 120 mA | 79.9 mA | 72.5 mA | 60 mA | 40 mA | 30 mA | 15 mA | 7.5 mA |
| Coil resistance | | | 25 Ω | 56.3 Ω | 69 Ω | 100 Ω | 225 Ω | 400 Ω | 1,600 Ω | 6,400 Ω |
| Coil inductance (H) (ref. value) | Set | Armature OFF | 0.015 | 0.04 | 0.05 | 0.07 | 0.16 | 0.28 | 1.1 | 4 |
| | | Armature ON | 0.01 | 0.025 | 0.035 | 0.05 | 0.12 | 0.2 | 0.75 | 2.9 |
| | Reset | Armature OFF | 0.01 | 0.025 | 0.035 | 0.05 | 0.12 | 0.2 | 0.75 | 2.9 |
| | | Armature ON | 0.015 | 0.04 | 0.05 | 0.07 | 0.16 | 0.28 | 1.1 | 4 |
| Must operate voltage | | | 70% max. of rated voltage | | | | | | | |
| Must release voltage | | | 70% max. of rated voltage | | | | | | | |
| Max. voltage | | | 150% of rated voltage at 23°C | | | | | | | |
| Power consumption | | | Approx. 360 mW | | | | | | | |

Double-winding Latching, Low-sensitivity 4PDT Relays

| | | | | | | | | | | |
|----------------------------------|-------|--------------|-------------------------------|---------|---------|-------|-------|--------|---------|---------|
| Rated voltage | | | 3 VDC | 4.5 VDC | 5 VDC | 6 VDC | 9 VDC | 12 VDC | 24 VDC | 48 VDC |
| Rated current | | | 120 mA | 79.9 mA | 72.5 mA | 60 mA | 40 mA | 30 mA | 15 mA | 7.5 mA |
| Coil resistance | | | 25 Ω | 56.3 Ω | 69 Ω | 100 Ω | 225 Ω | 400 Ω | 1,600 Ω | 6,400 Ω |
| Coil inductance (H) (ref. value) | Set | Armature OFF | 0.02 | 0.045 | 0.065 | 0.09 | 0.18 | 0.3 | 1.2 | 4.4 |
| | | Armature ON | 0.015 | 0.035 | 0.05 | 0.075 | 0.14 | 0.23 | 0.82 | 3.2 |
| | Reset | Armature OFF | 0.015 | 0.035 | 0.05 | 0.075 | 0.14 | 0.23 | 0.82 | 3.2 |
| | | Armature ON | 0.02 | 0.045 | 0.065 | 0.09 | 0.18 | 0.3 | 1.2 | 4.4 |
| Must operate voltage | | | 70% max. of rated voltage | | | | | | | |
| Must release voltage | | | 70% max. of rated voltage | | | | | | | |
| Max. voltage | | | 150% of rated voltage at 23°C | | | | | | | |
| Power consumption | | | Approx. 360 mW | | | | | | | |

- Note:**
1. The rated current and coil resistance are measured at a coil temperature of 23°C with a tolerance of ±10%.
 2. Operating characteristics are measured at a coil temperature of 23°C.

■ Contact Ratings

| Item | G6A-234P-ST(40)-US/434P-ST(40)-US | | G6A-274P-ST(40)-US/474P-ST(40)-US | |
|--------------------------------|--------------------------------------|--|--------------------------------------|--|
| Load | Resistive load ($\cos\phi = 1$) | Inductive load ($\cos\phi = 0.4$; L/R = 7 ms) | Resistive load ($\cos\phi = 1$) | Inductive load ($\cos\phi = 0.4$; L/R = 7 ms) |
| Rated load | 0.3 A at 125 VAC; 1 A at 30 VDC | 0.2 A at 125 VAC; 0.5 A at 30 VDC | 0.5 A at 125 VAC; 2 A at 30 VDC | 0.3 A at 125 VAC; 1 A at 30 VDC |
| Contact material | AgPd (Au-clad) | | Ag (Au-clad) | |
| Rated carry current | 3 A | | | |
| Max. switching voltage | 250 VAC, 220 VDC | | | |
| Max. switching current | 2 A | 1 A | 2 A | 1 A |
| Max. switching power | 125 VA, 60 W | 62.5 VA, 30 W | 125 VA, 60 W | 62.5 VA, 30 W |
| Failure rate (reference value) | 0.01 mA at 10 mVDC | | | |

| Item | G6AK-234P-ST(40)-US/G6AK-434P-ST(40)-US G6AU-234P-ST-US/G6AU-434P-ST-US | | G6AK-274P-ST(40)-US/G6AK-474P-ST(40)-US G6AU-274P-ST-US/G6AU-474P-ST-US | |
|--------------------------------|--|--|--|--|
| Load | Resistive load ($\cos\phi = 1$) | Inductive load ($\cos\phi = 0.4$; L/R = 7 ms) | Resistive load ($\cos\phi = 1$) | Inductive load ($\cos\phi = 0.4$; L/R = 7 ms) |
| Rated load | 0.3 A at 125 VAC; 1 A at 30 VDC | 0.2 A at 125 VAC; 0.5 A at 30 VDC | 0.5 A at 125 VAC; 2 A at 30 VDC | 0.25 A at 125 VAC; 1 A at 30 VDC |
| Contact material | AgPd (Au-clad) | | Ag (Au-clad) | |
| Rated carry current | 3 A | | | |
| Max. switching voltage | 250 VAC, 220 VDC | | | |
| Max. switching current | 2 A | 1 A | 2 A | 1 A |
| Max. switching power | 125 VA, 60 W | 62.5 VA, 30 W | 125 VA, 60 W | 62.5 VA, 30 W |
| Failure rate (reference value) | 0.01 mA at 10 mVDC | | | |

Note P level: $\lambda_{60} = 0.1 \times 10^{-6}/\text{operation}$

■ Characteristics

| | |
|------------------------------------|---|
| Contact resistance | 50 mΩ max. |
| Operate (set) time | Single-side stable types: DPDT: 5 ms max. (mean value: approx. 3 ms) 4PDT: 7 ms max. (mean value: approx. 3.8 ms) Latching types: DPDT: 5 ms max. (mean value: approx. 2.5 ms) 4PDT: 7 ms max. (mean value: approx. 3.3 ms) |
| Release (reset) time | Single-side stable types: DPDT: 3 ms max. (mean value: approx. 1.2 ms) 4PDT: 5 ms max. (mean value: approx. 1.3 ms) Latching types: DPDT: 5 ms max. (mean value: approx. 2.5 ms) 4PDT: 7 ms max. (mean value: approx. 2.7 ms) |
| Bounce time | Operate: mean value: approx. 0.5 ms Release: mean value: approx. 0.5 ms |
| Min. set/reset signal width | DPDT: 7 ms min. 4PDT: 15 ms min. |
| Max. operating frequency | Mechanical: 36,000 operations/hr Electrical: 1,800 operations/hr (under rated load) |
| Insulation resistance | 1,000 MΩ min. (at 500 VDC); except for set-reset |
| Dielectric strength | 1,000 VAC, 50/60 Hz for 1 min between coil and contacts 1,000 VAC, 50/60 Hz for 1 min between contacts of different polarity 1,000 VAC, 50/60 Hz for 1 min between contacts of same polarity 250 VAC, 50/60 Hz for 1 min between set and reset coils |
| Impulse withstand voltage | 1,500 V (10 x 160 μs) (conforms to FCC Part 68) |
| Vibration resistance | Destruction: 10 to 55 to 10 Hz, 2.5-mm single amplitude (5-mm double amplitude) Malfunction: 10 to 55 to 10 Hz, 1.65-mm single amplitude (3.3-mm double amplitude) |
| Shock resistance | Destruction: 1,000 m/s ² (approx. 100G) Malfunction: DPDT: 500 m/s ² (approx. 50G) 4PDT, Latching type: 300 m/s ² (approx. 30G) |
| Endurance | Mechanical: 100,000,000 operations min. (at 36,000 operations/hr) Electrical: 500,000 operations min. (at 1,800 operations/hr) |
| Ambient temperature | Operating: -40°C to 70°C (with no icing) |
| Ambient humidity | Operating: 5% to 85% |
| Weight | DPDT: Approx. 3.5 g 4PDT: Approx. 6 g |

Note The data shown above are initial values.

■ Approved Standards

UL114, UL478 (File No. E41515)/CSA C22.2 No.0, No.14 (File No. LR24825)

| Model | Contact form | Coil ratings | Contact ratings |
|--|--------------|--------------|---|
| G6A-234P-ST(40)-US G6AK-234P-ST(40)-US G6AU-234P-ST-US | DPDT | 3 to 48 VDC | 0.6 A, 125 VAC 1 A, 30 VDC 0.6 A, 110 VDC |
| G6A-274P-ST(40)-US G6AK-274P-ST(40)-US G6AU-274P-ST-US | DPDT | | 0.6 A, 125 VAC 2 A, 30 VDC 0.6 A, 110 VDC |
| G6A-434P-ST(40)-US G6AK-434P-ST(40)-US G6AU-434P-ST-US | 4PDT | | 0.6 A, 125 VAC 1 A, 30 VDC 0.6 A, 110 VDC |
| G6A-474P-ST(40)-US G6AK-474P-ST(40)-US G6AU-474P-ST-US | 4PDT | | 0.6 A, 125 VAC 2 A, 30 VDC 0.6 A, 110 VDC |

Engineering Data

Maximum Switching Power DPDT, 4PDT

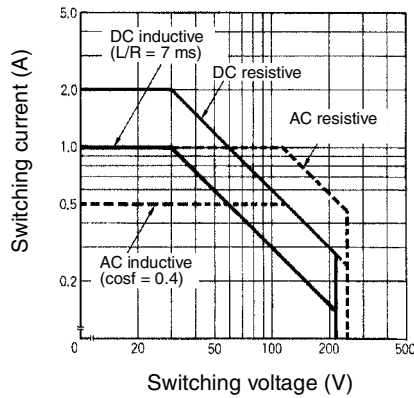

Ambient Temperature vs. Maximum Coil Voltage

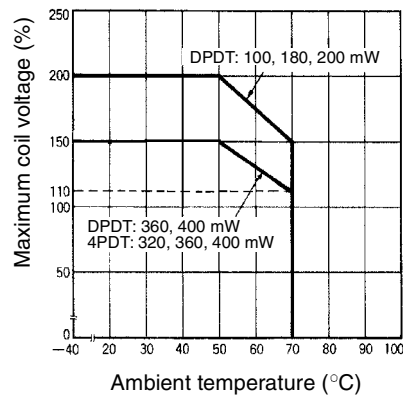

Note: The maximum coil voltage refers to the maximum value in a varying range of operating power voltage, not a continuous voltage.

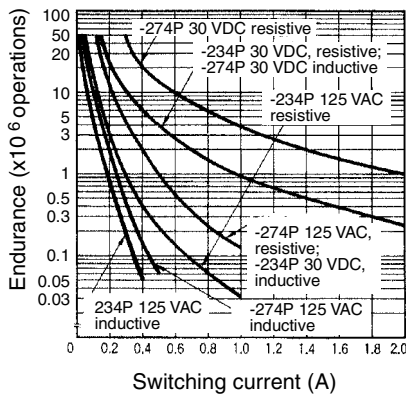

Endurance DPDT

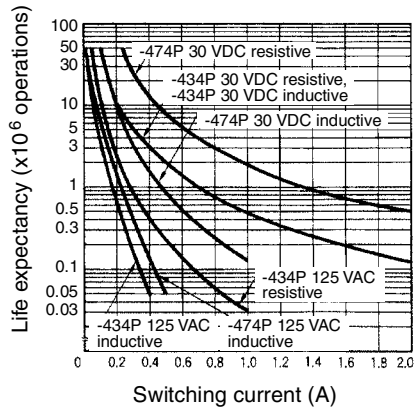

4PDT



Dimensions

- Note:** 1. All units are in millimeters unless otherwise indicated.
 2. Orientation marks are indicated as follows:  

G6A-234P-ST(40)-US, G6A-274P-ST(40)-US

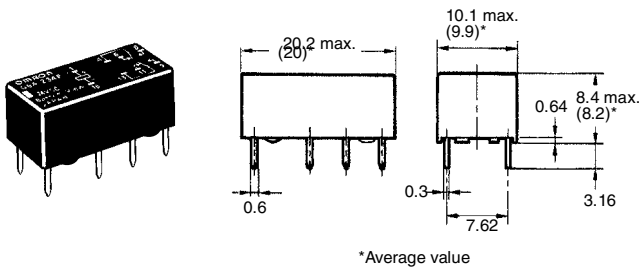

Terminal Arrangement/ Internal Connections (Bottom View)

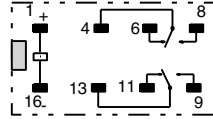

Mounting Holes (Bottom View)

Tolerance: ± 0.1

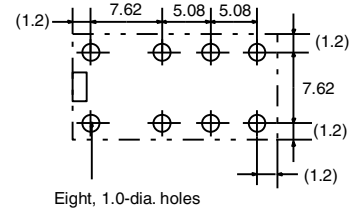

G6A-434P-ST(40)-US, G6A-474P-ST-US

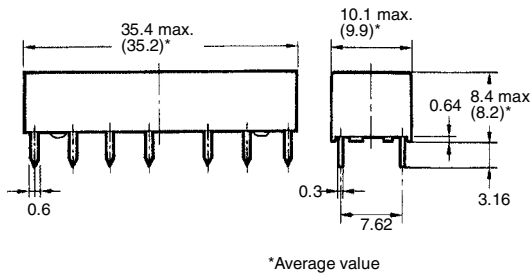
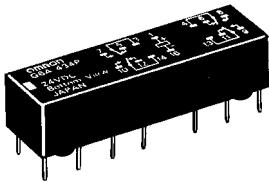

Terminal Arrangement/ Internal Connections (Bottom View)

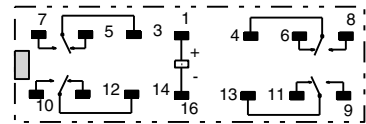

Mounting Holes (Bottom View)

Tolerance: ± 0.1

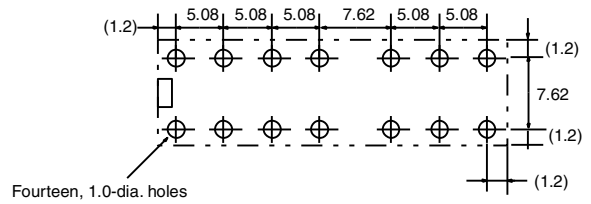

G6AK-234P-ST(40)-US, G6AK-274P-ST(40)-US

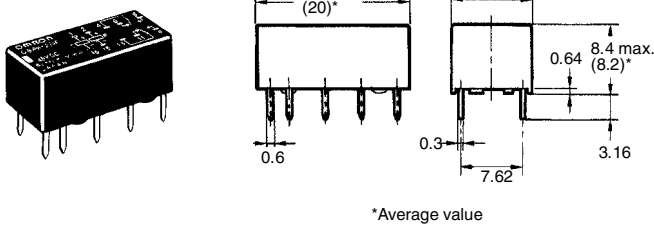

Terminal Arrangement/ Internal Connections (Bottom View)

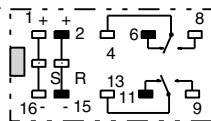

Mounting Holes (Bottom View)

Tolerance: ± 0.1

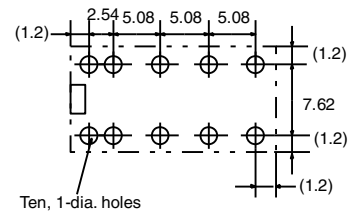

**G6AK-434P-ST(40)-US,
G6AK-474P-ST(40)-US**

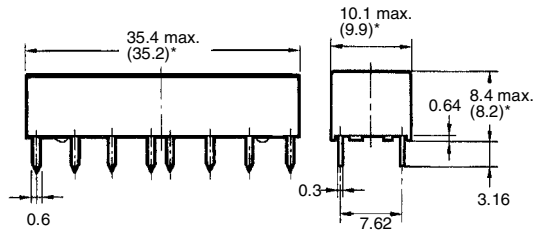
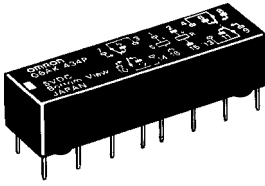

*Average value

**Terminal Arrangement/
Internal Connections
(Bottom View)**

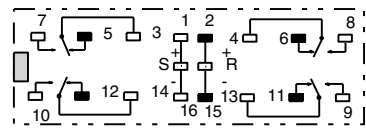

**Mounting Holes
(Bottom View)**

Tolerance: ± 0.1

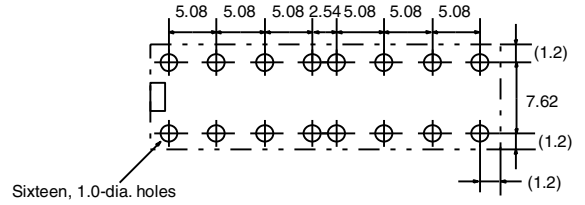

**G6AU-234P-ST-US,
G6AU-274P-ST-US**

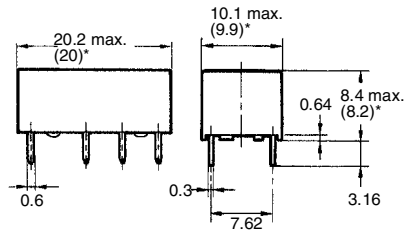
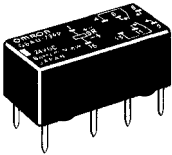

*Average value

**Terminal Arrangement/
Internal Connections
(Bottom View)**

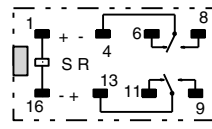

**Mounting Holes
(Bottom View)**

Tolerance: ± 0.1

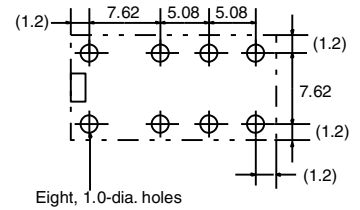

**G6AU-434P-US,
G6AU-474P-ST-US**

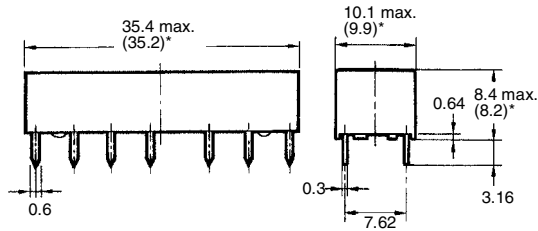
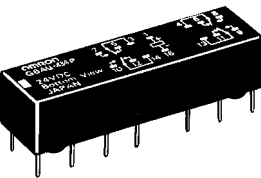

*Average value

**Terminal Arrangement/
Internal Connections
(Bottom View)**

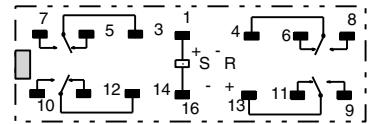

**Mounting Holes
(Bottom View)**

Tolerance: ± 0.1

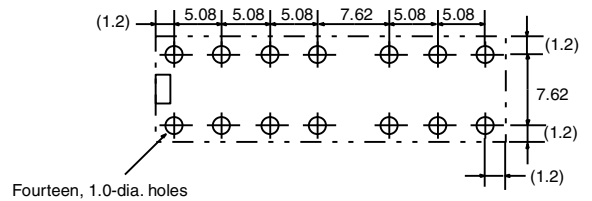

ALL DIMENSIONS SHOWN ARE IN MILLIMETERS.
To convert millimeters into inches, multiply by 0.03937. To convert grams into ounces, multiply by 0.03527.