

**Features**

- 130 MHz 3 dB bandwidth ( $A_V = +2$ )
- 180 MHz 3 dB bandwidth ( $A_V = +1$ )
- 0.01% differential gain,  $R_L = 500\Omega$
- 0.01° differential phase,  $R_L = 500\Omega$
- Low supply current, 7.5 mA per amplifier
- Wide supply range,  $\pm 2V$  to  $\pm 15V$
- 80 mA output current (peak)
- Low cost
- 1500 V/ $\mu s$  slew rate
- Input common mode range to within 1.5V of supplies
- 35 ns settling time to 0.1%

**Applications**

- Video amplifiers
- Cable drivers
- RGB amplifiers
- Test equipment amplifiers
- Current to voltage converter

**Ordering Information**

Part No.	Temp. Range	Package	Outline #
EL2260CN	-40°C to +85°C	8-Pin P-DIP	MDP0031
EL2260CS	-40°C to +85°C	8-Pin SOIC	MDP0027
EL2460CN	-40°C to +85°C	14-Pin P-DIP	MDP0031
EL2460CS	-40°C to +85°C	14-Pin SOIC	MDP0027

**General Description**

The EL2260C/EL2460C are dual/quad current feedback operational amplifiers with -3 dB bandwidth of 130 MHz at a gain of +2. Built using the Elantec proprietary monolithic complementary bipolar process, these amplifiers use current mode feedback to achieve more bandwidth at a given gain than a conventional voltage feedback operational amplifier.

The EL2260C/EL2460C are designed to drive a double terminated 75Ω coax cable to video levels. Differential gain and phase are excellent when driving both loads of 500Ω (<0.01% / <0.01°) and double terminated 75Ω cables (0.025%/0.1°).

The amplifiers can operate on any supply voltage from 4V ( $\pm 2V$ ) to 33V ( $\pm 16.5V$ ), yet consume only 7.5 mA per amplifier at any supply voltage. Using industry standard pinouts, the EL2260C is available in 8-pin P-DIP and 8-pin SO packages, while the EL2460C is available in 14-pin P-DIP and 14-pin SO packages.

Elantec's facilities comply with MIL-I-45208A and offer applicable quality specifications. For information on Elantec's processing, see the Elantec document, QRA-1: *Elantec's Processing—Monolithic Products*.

**Connection Diagrams**

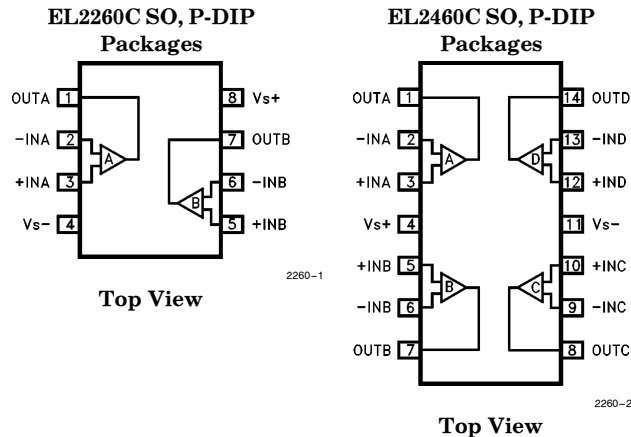

Note: All information contained in this data sheet has been carefully checked and is believed to be accurate as of the date of publication; however, this data sheet cannot be a "controlled document". Current revisions, if any, to these specifications are maintained at the factory and are available upon your request. We recommend checking the revision level before finalization of your design documentation.

# ***EL2260C/EL2460C***

## ***Dual/Quad 130 MHz Current Feedback Amplifiers***

### Absolute Maximum Ratings ( $T_A = 25^\circ\text{C}$ )

Voltage between $V_S^+$ and $V_S^-$	+33V	Operating Ambient Temperature Range	-40°C to +85°C
Voltage between +IN and -IN	±6V	Operating Junction Temperature	
Current into +IN or -IN	10 mA	Plastic Packages	150°C
Internal Power Dissipation	See Curves	Storage Temperature Range	-65°C to +150°C
		Output Current	±50 mA

#### Important Note:

All parameters having Min/Max specifications are guaranteed. The Test Level column indicates the specific device testing actually performed during production and Quality inspection. Elantec performs most electrical tests using modern high-speed automatic test equipment, specifically the LTX77 Series system. Unless otherwise noted, all tests are pulsed tests, therefore  $T_J = T_C = T_A$ .

Test Level	Test Procedure
I	100% production tested and QA sample tested per QA test plan QCX0002.
II	100% production tested at $T_A = 25^\circ\text{C}$ and QA sample tested at $T_A = 25^\circ\text{C}$ , $T_{MAX}$ and $T_{MIN}$ per QA test plan QCX0002.
III	QA sample tested per QA test plan QCX0002.
IV	Parameter is guaranteed (but not tested) by Design and Characterization Data.
V	Parameter is typical value at $T_A = 25^\circ\text{C}$ for information purposes only.

### Open Loop DC Electrical Characteristics

$V_S = \pm 15\text{V}$ ,  $R_L = 150\Omega$ ,  $T_A = 25^\circ\text{C}$  unless otherwise specified

Parameter	Description	Conditions	Temp	Limits			Test Level	Units
				Min	Typ	Max		
$V_{OS}$	Input Offset Voltage	$V_S = \pm 5\text{V}, \pm 15\text{V}$	25°C		2	10	I	mV
			$T_{MIN}, T_{MAX}$			15	III	mV
$TC V_{OS}$	Average Offset Voltage Drift (Note 1)		Full		10		V	$\mu\text{V}/^\circ\text{C}$
$+I_{IN}$	+ Input Current	$V_S = \pm 5\text{V}, \pm 15\text{V}$	25°C		0.5	5	I	$\mu\text{A}$
			$T_{MIN}, T_{MAX}$			10	III	$\mu\text{A}$
$-I_{IN}$	- Input Current	$V_S = \pm 5\text{V}, \pm 15\text{V}$	25°C		5	25	I	$\mu\text{A}$
			$T_{MIN}, T_{MAX}$			35	III	$\mu\text{A}$
$CMRR$	Common Mode Rejection Ratio (Note 2)	$V_S = \pm 5\text{V}, \pm 15\text{V}$	Full	50	55		II	dB
$-ICMR$	- Input Current Common Mode Rejection (Note 2)	$V_S = \pm 5\text{V}, \pm 15\text{V}$	25°C		0.2	5	I	$\mu\text{A}/\text{V}$
			$T_{MIN}, T_{MAX}$			5	III	$\mu\text{A}/\text{V}$
$PSRR$	Power Supply Rejection Ratio (Note 3)		Full	75	95		II	dB
$-IPSR$	- Input Current Power Supply Rejection (Note 3)		25°C		0.2	5	I	$\mu\text{A}/\text{V}$
			$T_{MIN}, T_{MAX}$			5	III	$\mu\text{A}/\text{V}$

# EL2260C/EL2460C

## Dual/Quad 130 MHz Current Feedback Amplifiers

### Open Loop DC Electrical Characteristics — Contd.

$V_S = \pm 15V$ ,  $R_L = 150\Omega$ ,  $T_A = 25^\circ C$  unless otherwise specified

Parameter	Description	Conditions	Temp	Limits			Test Level	Units
				Min	Typ	Max	EL2260C EL2460C	
$R_{OL}$	Transimpedance (Note 4)	$V_S = \pm 15V$ $R_L = 400\Omega$	$25^\circ C$	500	2000		I	$k\Omega$
			$T_{MIN}, T_{MAX}$	250			III	$k\Omega$
		$V_S = \pm 5V$ $R_L = 150\Omega$	$25^\circ C$	500	1800		I	$k\Omega$
			$T_{MIN}, T_{MAX}$	250			III	$k\Omega$
$+R_{IN}$	+ Input Resistance		Full	1.5	3.0		II	$M\Omega$
$+C_{IN}$	+ Input Capacitance		$25^\circ C$		2.5		V	pF
CMIR	Common Mode Input Range	$V_S = \pm 15V$	$25^\circ C$		$\pm 13.5$		V	V
		$V_S = \pm 5V$	$25^\circ C$		$\pm 3.5$		V	V
$V_O$	Output Voltage Swing	$R_L = 400\Omega$ , $V_S = \pm 15V$	$25^\circ C$	$\pm 12$	$\pm 13.5$		I	V
			$T_{MIN}, T_{MAX}$	$\pm 11$			III	V
		$R_L = 150\Omega$ , $V_S = \pm 15V$	$25^\circ C$		$\pm 12$		V	V
		$R_L = 150\Omega$ , $V_S = \pm 5V$	$25^\circ C$	$\pm 3.0$	$\pm 3.7$		I	V
			$T_{MIN}, T_{MAX}$	$\pm 2.5$			III	V
$I_{SC}$	Output Short Circuit Current (Note 5)	$V_S = \pm 5V$ , $V_S = \pm 15V$	$25^\circ C$	60	100	150	I	mA
$I_S$	Supply Current (Per Amplifier)	$V_S = \pm 15V$	$25^\circ C$		7.5	11.0	I	mA
			$T_{MIN}, T_{MAX}$			11.0	III	mA
		$V_S = \pm 5V$	$25^\circ C$		5.4	8.5	I	mA
			$T_{MIN}, T_{MAX}$			8.5	III	mA

# EL2260C/EL2460C

## Dual/Quad 130 MHz Current Feedback Amplifiers

### Closed Loop AC Electrical Characteristics

$V_S = \pm 15V$ ,  $A_V = +2$ ,  $R_F = 560\Omega$ ,  $R_L = 150\Omega$ ,  $T_A = 25^\circ C$  unless otherwise noted

Parameter	Description	Test Conditions	Limits			Test Level	Units
			Min	Typ	Max	EL2260C EL2460C	
BW	- 3 dB Bandwidth (Note 8)	$V_S = \pm 15V$ , $A_V = +2$		130		V	MHz
		$V_S = \pm 15V$ , $A_V = +1$		180		V	MHz
		$V_S = \pm 5V$ , $A_V = +2$		100		V	MHz
		$V_S = \pm 5V$ , $A_V = +1$		110		V	MHz
SR	Slew Rate (Notes 6, 8)	$R_L = 400\Omega$	1000	1500		IV	V/ $\mu s$
		$R_F = 1K\Omega$ , $R_G = 110\Omega$ $R_L = 400\Omega$		1500		V	V/ $\mu s$
$t_r$ , $t_f$	Rise Time, Fall Time, (Note 8)	$V_{OUT} = \pm 500mV$		2.7		V	ns
$t_{pd}$	Propagation Delay (Note 8)			3.2		V	ns
OS	Overshoot (Note 8)	$V_{OUT} = \pm 500 mV$		0		V	%
$t_s$	0.1% Settling Time (Note 8)	$V_{OUT} = \pm 10V$ $A_V = -1$ , $R_L = 1K$		35		V	ns
dG	Differential Gain (Notes 7, 8)	$R_L = 150\Omega$		0.025		V	%
		$R_L = 500\Omega$		0.006		V	%
dP	Differential Phase (Notes 7, 8)	$R_L = 150\Omega$		0.1		V	deg ( $^\circ$ )
		$R_L = 500\Omega$		0.005		V	deg ( $^\circ$ )

Note 1: Measured from  $T_{MIN}$  to  $T_{MAX}$ .

Note 2:  $V_{CM} = \pm 10V$  for  $V_S = \pm 15V$  and  $T_A = Full$

$V_{CM} = \pm 3V$  for  $V_S = \pm 5V$  and  $T_A = 25^\circ C$

$V_{CM} = \pm 2V$  for  $V_S = \pm 5V$  and  $T_A = T_{MIN}, T_{MAX}$

Note 3: The supplies are moved from  $\pm 2.5V$  to  $\pm 15V$ .

Note 4:  $V_{OUT} = \pm 7V$  for  $V_S = \pm 15V$ , and  $V_{OUT} = \pm 2V$  for  $V_S = \pm 5V$ .

Note 5: A heat sink is required to keep junction temperature below absolute maximum when an output is shorted.

Note 6: Slew Rate is with  $V_{OUT}$  from  $+10V$  to  $-10V$  and measured at the 25% and 75% points.

Note 7: DC offset from  $-0.714V$  through  $+0.714V$ , AC amplitude  $286 mV_{p-p}$ ,  $f = 3.58 MHz$ .

Note 8: All AC tests are performed on a "warmed up" part, except for Slew Rate, which is pulse tested.

# EL2260C/EL2460C

## Dual/Quad 130 MHz Current Feedback Amplifiers

### Typical Performance Curves

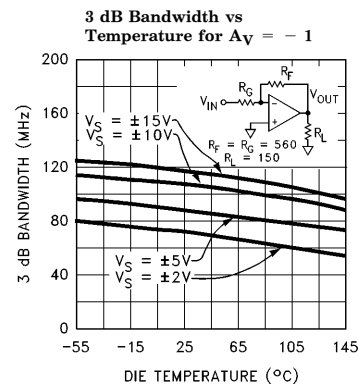
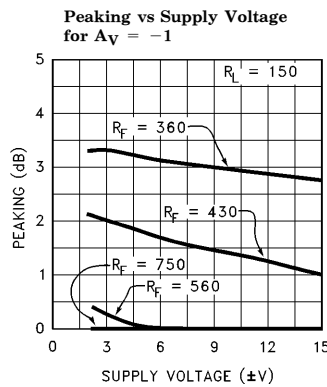
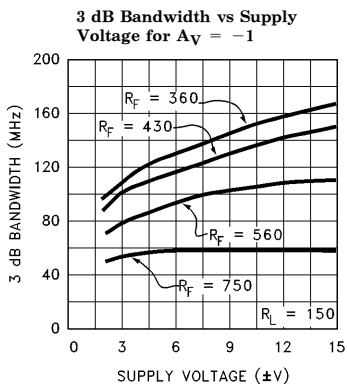
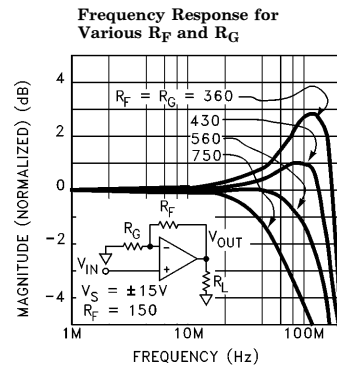
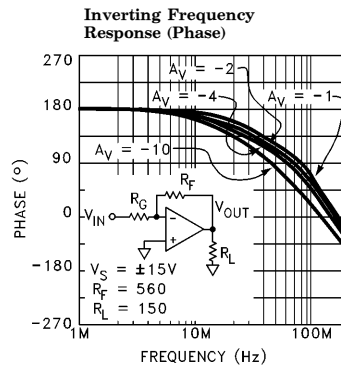
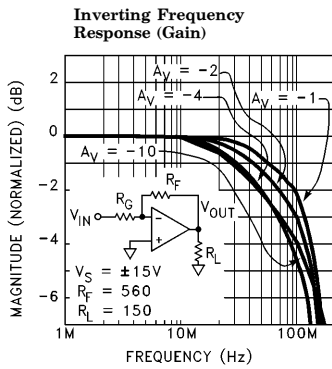
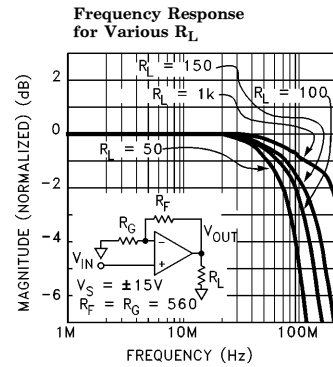
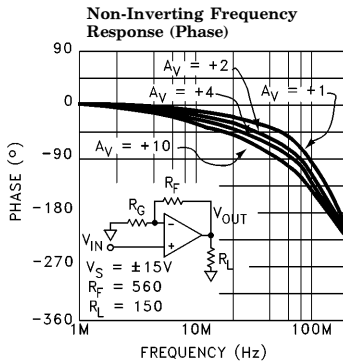
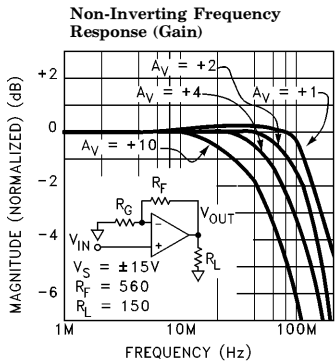

2260-3

# EL2260C/EL2460C

## Dual/Quad 130 MHz Current Feedback Amplifiers

### Typical Performance Curves — Contd.

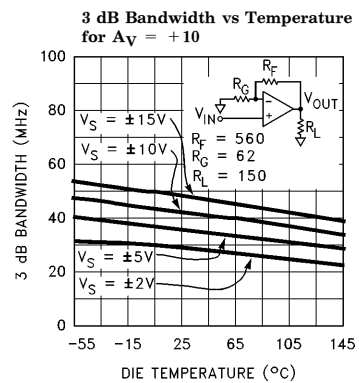
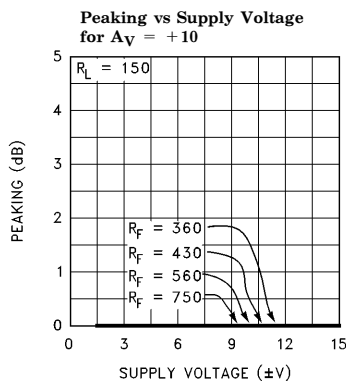
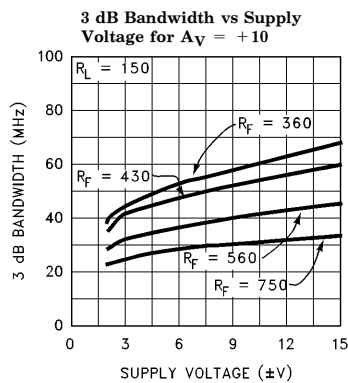
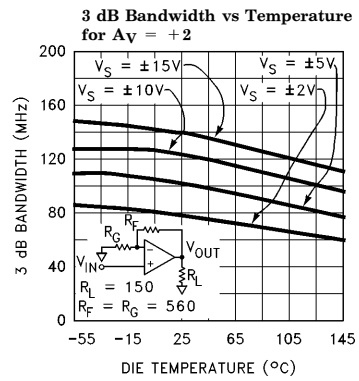
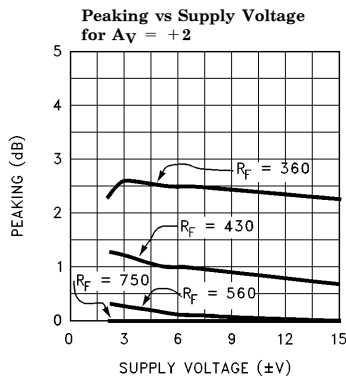
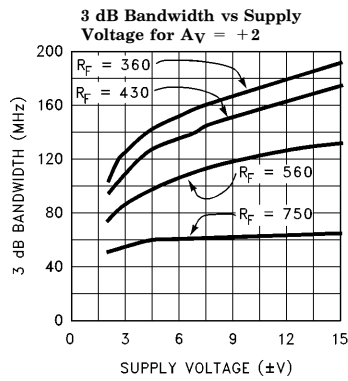
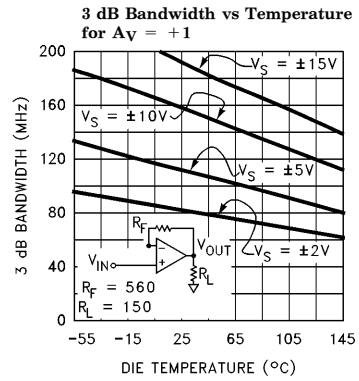
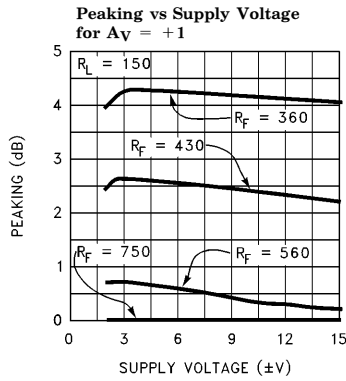
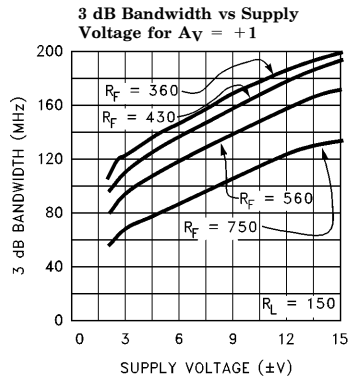

2260-4

# EL2260C/EL2460C

## Dual/Quad 130 MHz Current Feedback Amplifiers

### Typical Performance Curves — Contd.

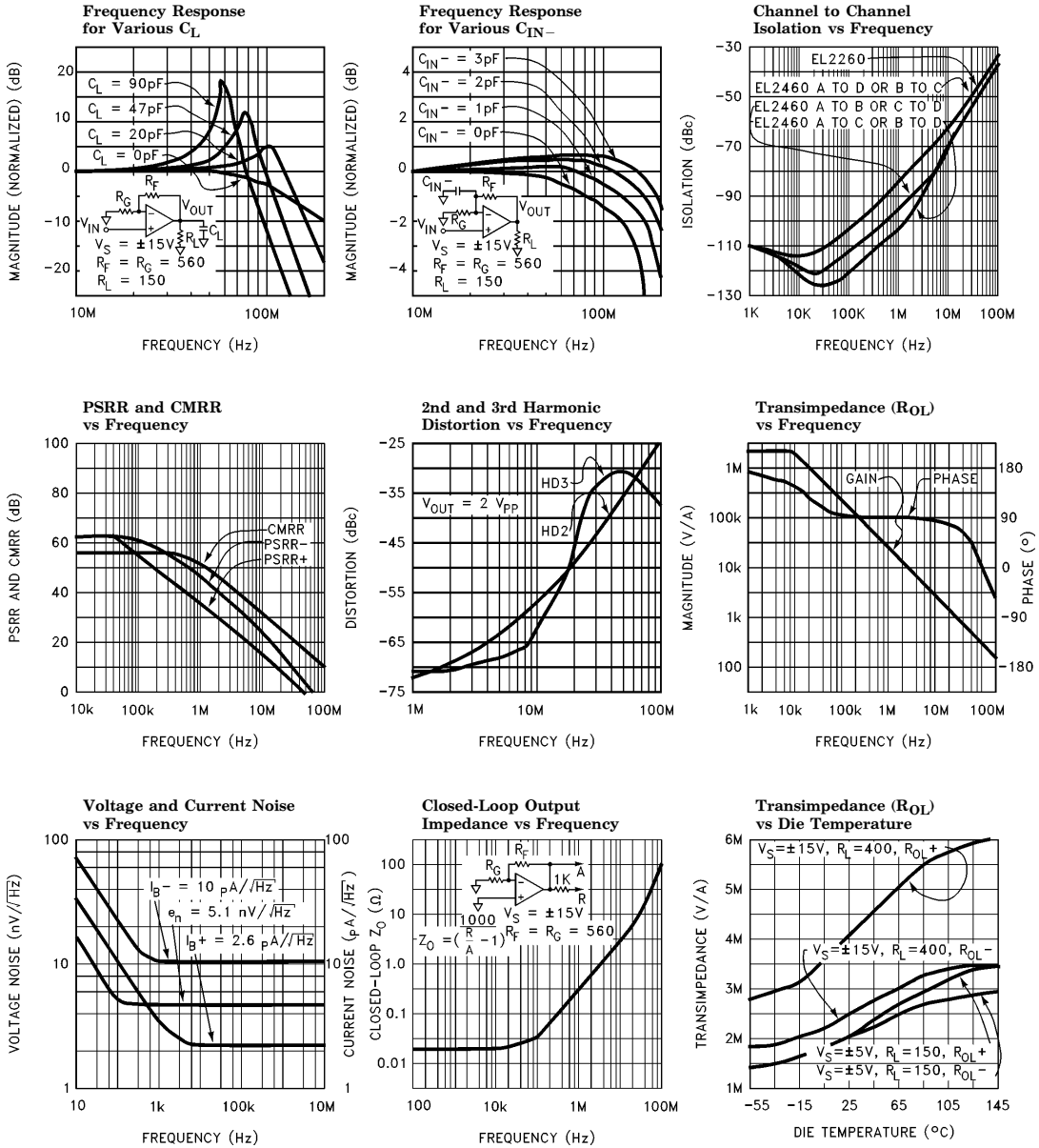

2260-5

# EL2260C/EL2460C

## Dual/Quad 130 MHz Current Feedback Amplifiers

### Typical Performance Curves — Contd.

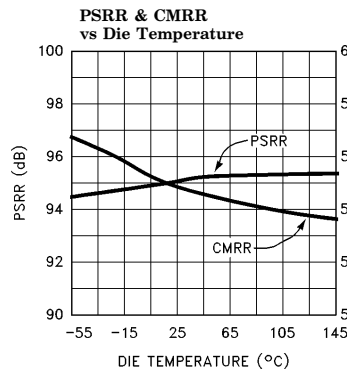
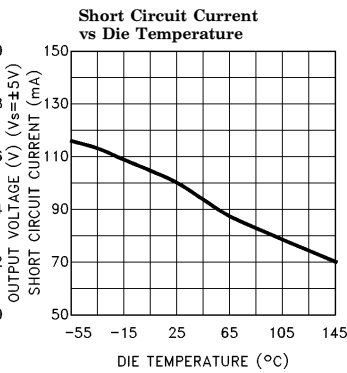
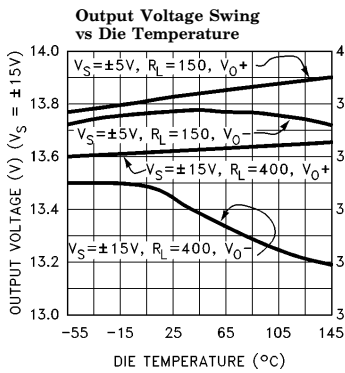
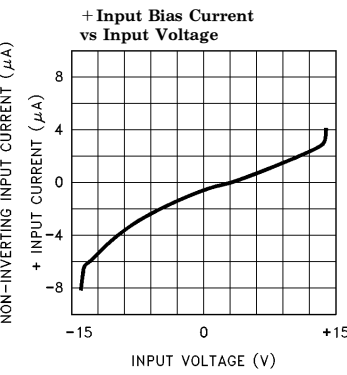
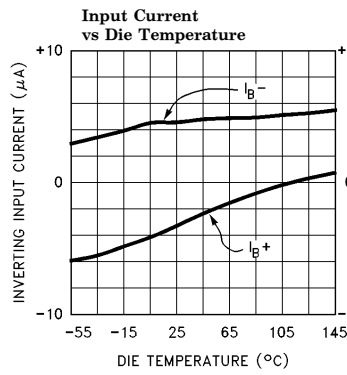
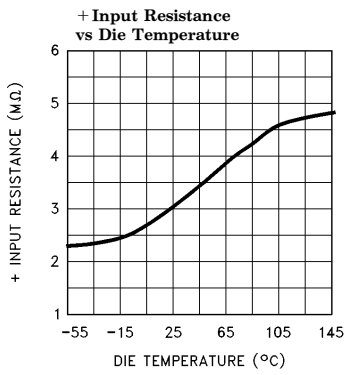
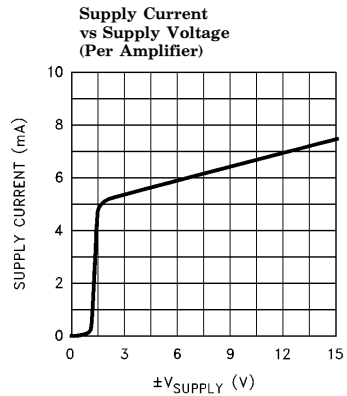
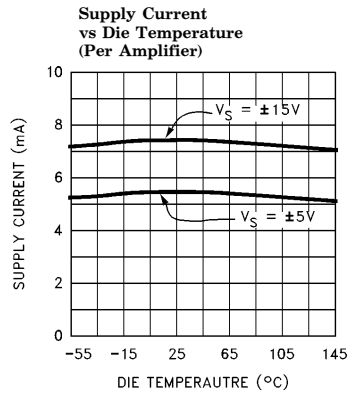
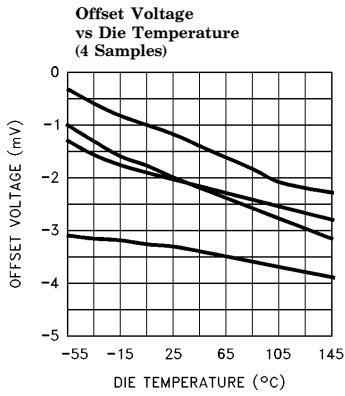

2260-6



# EL2260C/EL2460C

## Dual/Quad 130 MHz Current Feedback Amplifiers

### Typical Performance Curves — Contd.

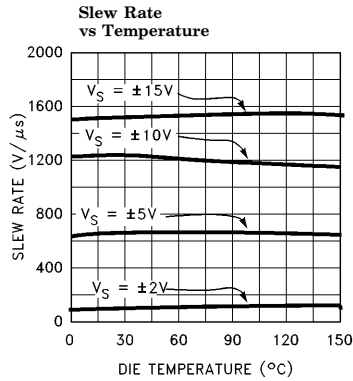
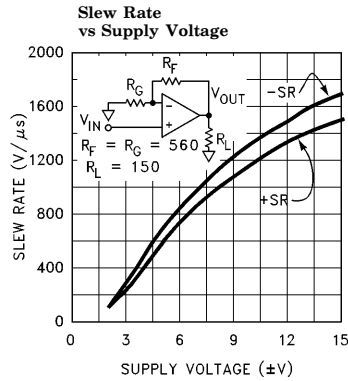
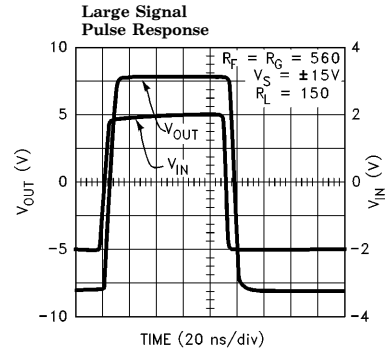
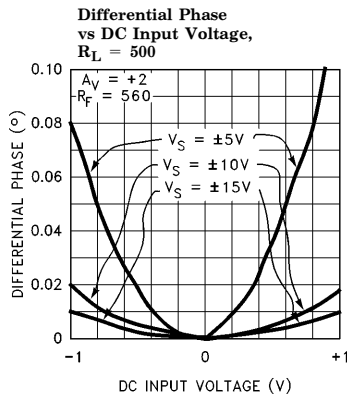
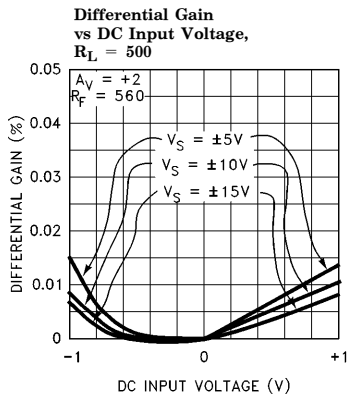
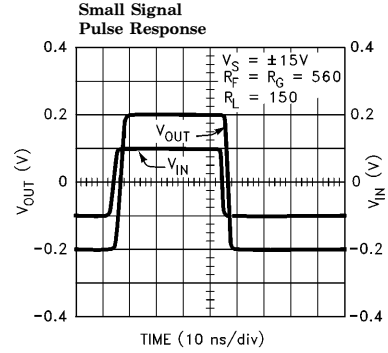
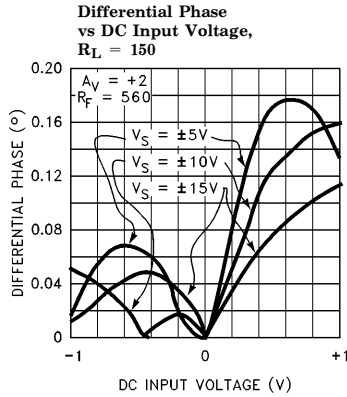
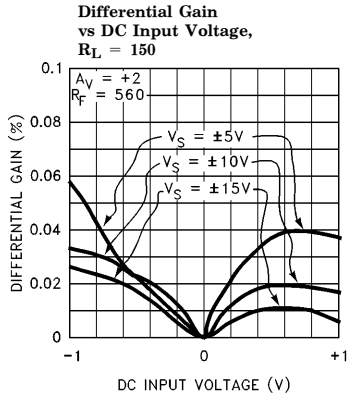

2260-7

# EL2260C/EL2460C

## Dual/Quad 130 MHz Current Feedback Amplifiers

### Typical Performance Curves — Contd.

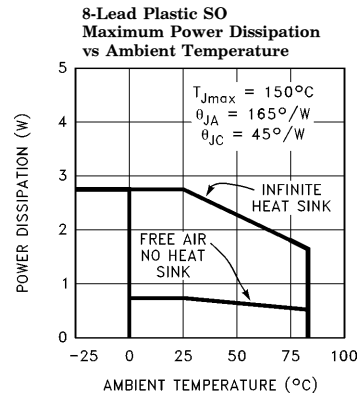
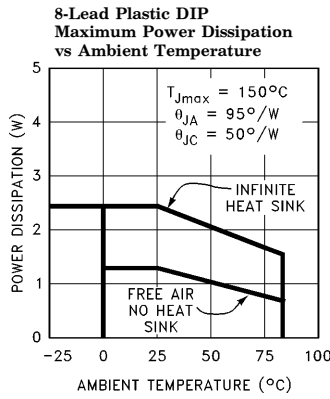
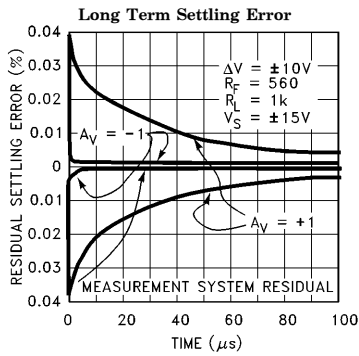
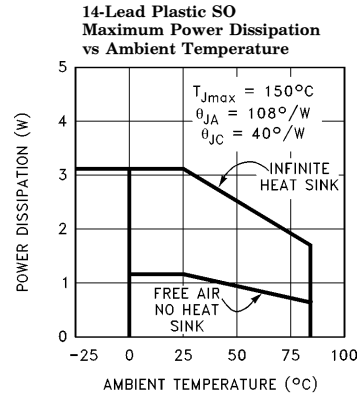
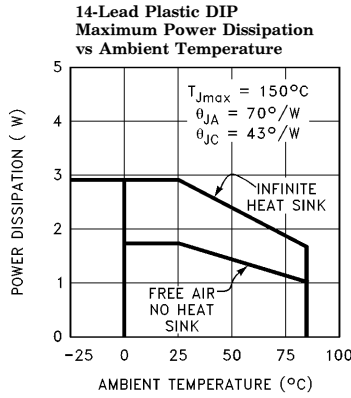
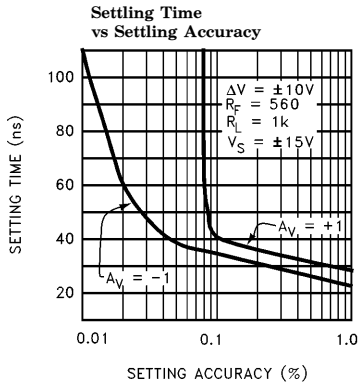

2260-8

### Burn-In Circuits

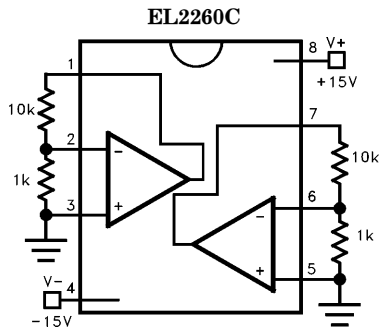

2260-11

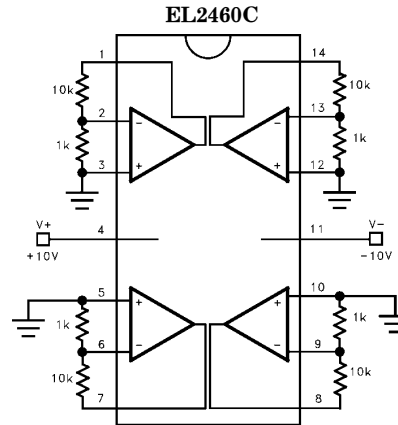

2260-12

# EL2260C/EL2460C

## Dual/Quad 130 MHz Current Feedback Amplifiers

### Differential Gain and Phase Test Circuit

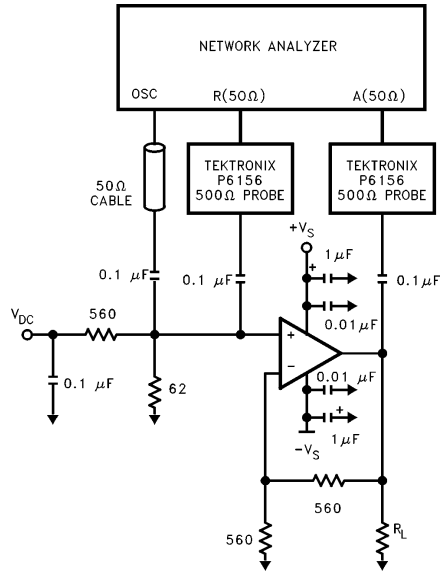

2260-9

### Simplified Schematic (One Amplifier)

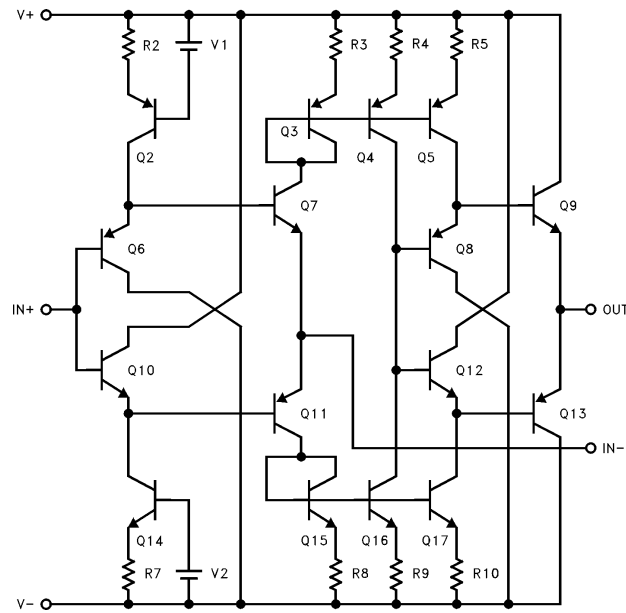

2260-10

# ***EL2260C/EL2460C***

## ***Dual/Quad 130 MHz Current Feedback Amplifiers***

### **Applications Information**

#### **Product Description**

The EL2260C/EL2460C are dual and quad current mode feedback amplifiers that offer wide bandwidths and good video specifications at moderately low supply currents. They are built using Elantec's proprietary complimentary bipolar process and are offered in industry standard pin-outs. Due to the current feedback architecture, the EL2260C/EL2460C closed-loop 3 dB bandwidth is dependent on the value of the feedback resistor. First the desired bandwidth is selected by choosing the feedback resistor,  $R_F$ , and then the gain is set by picking the gain resistor,  $R_G$ . The curves at the beginning of the Typical Performance Curves section show the effect of varying both  $R_F$  and  $R_G$ . The 3 dB bandwidth is somewhat dependent on the power supply voltage. As the supply voltage is decreased, internal junction capacitances increase, causing a reduction in closed loop bandwidth. To compensate for this, smaller values of feedback resistor can be used at lower supply voltages.

#### **Power Supply Bypassing and Printed Circuit Board Layout**

As with any high frequency device, good printed circuit board layout is necessary for optimum performance. Ground plane construction is highly recommended. Lead lengths should be as short as possible, below  $\frac{1}{4}$ ". The power supply pins must be well bypassed to reduce the risk of oscillation. A  $1.0 \mu\text{F}$  tantalum capacitor in parallel with a  $0.01 \mu\text{F}$  ceramic capacitor is adequate for each supply pin.

For good AC performance, parasitic capacitances should be kept to a minimum, especially at the inverting input (see Capacitance at the Inverting Input section). This implies keeping the ground plane away from this pin. Carbon resistors are acceptable, while use of wire-wound resistors should not be used because of their parasitic inductance. Similarly, capacitors should be low inductance for best performance. Use of sockets, particularly for the SO packages, should be avoided. Sockets add parasitic inductance and capacitance which will result in peaking and overshoot.

#### **Capacitance at the Inverting Input**

Due to the topology of the current feedback amplifier, stray capacitance at the inverting input will affect the AC and transient performance of the EL2260C/EL2460C when operating in the non-inverting configuration. The characteristic curve of gain vs. frequency with variations of  $C_{IN-}$  emphasizes this effect. The curve illustrates how the bandwidth can be extended to beyond 200 MHz with some additional peaking with an additional 2 pF of capacitance at the  $V_{IN-}$  pin for the case of  $A_V = +2$ . Higher values of capacitance will be required to obtain similar effects at higher gains.

In the inverting gain mode, added capacitance at the inverting input has little effect since this point is at a virtual ground and stray capacitance is therefore not "seen" by the amplifier.

#### **Feedback Resistor Values**

The EL2260C and EL2460C have been designed and specified with  $R_F = 560\Omega$  for  $A_V = +2$ . This value of feedback resistor yields extremely flat frequency response with little to no peaking out to 130 MHz. As is the case with all current feedback amplifiers, wider bandwidth, at the expense of slight peaking, can be obtained by reducing the value of the feedback resistor. Inversely, larger values of feedback resistor will cause rolloff to occur at a lower frequency. By reducing  $R_F$  to  $430\Omega$ , bandwidth can be extended to 170 MHz with under 1 dB of peaking. Further reduction of  $R_F$  to  $360\Omega$  increases the bandwidth to 195 MHz with about 2.5 dB of peaking. See the curves in the Typical Performance Curves section which show 3 dB bandwidth and peaking vs. frequency for various feedback resistors and various supply voltages.

#### **Bandwidth vs Temperature**

Whereas many amplifier's supply current and consequently 3 dB bandwidth drop off at high temperature, the EL2260C/EL2460C were designed to have little supply current variations with temperature. An immediate benefit from this is that the 3 dB bandwidth does not drop off drastically with temperature. With  $V_S = \pm 15\text{V}$  and  $A_V = +2$ , the bandwidth only varies from 150 MHz to 110 MHz over the entire die junction temperature range of  $0^\circ\text{C} < T < 150^\circ\text{C}$ .

# EL2260C/EL2460C

## Dual/Quad 130 MHz Current Feedback Amplifiers

### Applications Information — Contd.

#### Supply Voltage Range

The EL2260C/EL2460C has been designed to operate with supply voltages from  $\pm 2V$  to  $\pm 15V$ . Optimum bandwidth, slew rate, and video characteristics are obtained at higher supply voltages. However, at  $\pm 2V$  supplies, the 3 dB bandwidth at  $A_V = +2$  is a respectable 70 MHz. The following figure is an oscilloscope plot of the EL2260C at  $\pm 2V$  supplies,  $A_V = +2$ ,  $R_F = R_G = 560\Omega$ , driving a load of  $150\Omega$ , showing a clean  $\pm 600$  mV signal at the output.

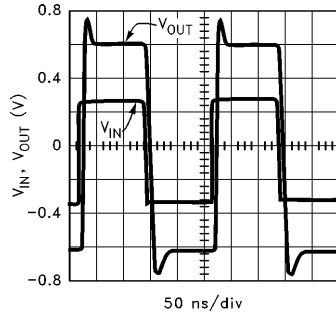

2260-13

If a single supply is desired, values from  $+4V$  to  $+30V$  can be used as long as the input common mode range is not exceeded. When using a single supply, be sure to either 1) DC bias the inputs at an appropriate common mode voltage and AC couple the signal, or 2) ensure the driving signal is within the common mode range of the EL2260C/EL2460C.

#### Settling Characteristics

The EL2260C/EL2460C offer superb settling characteristics to 0.1%, typically in the 35 ns to 40 ns range. There are no aberrations created from the input stage which often cause longer settling times in other current feedback amplifiers. The EL2260C/EL2460C are not slew rate limited, therefore any size step up to  $\pm 10V$  gives approximately the same settling time.

As can be seen from the Long Term Settling Error curve, for  $A_V = +1$ , there is approximately a 0.035% residual which tails away to 0.01% in about 40  $\mu s$ . This is a thermal settling error

caused by a power dissipation differential (before and after the voltage step). For  $A_V = -1$ , due to the inverting mode configuration, this tail does not appear since the input stage does not experience the large voltage change as in the non-inverting mode. With  $A_V = -1$ , 0.01% settling time is slightly greater than 100 ns.

#### Power Dissipation

The EL2260C/EL2460C amplifiers combine both high speed and large output current drive capability at a moderate supply current in very small packages. It is possible to exceed the maximum junction temperature allowed under certain supply voltage, temperature, and loading conditions. To ensure that the EL2260C/EL2460C remain within their absolute maximum ratings, the following discussion will help to avoid exceeding the maximum junction temperature.

The maximum power dissipation allowed in a package is determined by its thermal resistance and the amount of temperature rise according to

$$P_{DMAX} = \frac{T_{JMAX} - T_{AMAX}}{\theta_{JA}}$$

The maximum power dissipation actually produced by an IC is the total quiescent supply current times the total power supply voltage plus the power in the IC due to the load, or

$$P_{DMAX} = N * \left( 2 * V_S * I_S + (V_S - V_{OUT}) * \frac{V_{OUT}}{R_L} \right)$$

where N is the number of amplifiers per package, and  $I_S$  is the current per amplifier. (To be more accurate, the quiescent supply current flowing in the output driver transistor should be subtracted from the first term because, under loading and due to the class AB nature of the output stage, the output driver current is now included in the second term.)

In general, an amplifier's AC performance degrades at higher operating temperature and lower supply current. Unlike some amplifiers, such as the LT1229 and LT1230, the EL2260C/EL2460C

# EL2260C/EL2460C

## Dual/Quad 130 MHz Current Feedback Amplifiers

**Applications Information** — Contd.  
maintain almost constant supply current over temperature so that AC performance is not degraded as much over the entire operating temperature range. Of course, this increase in performance doesn't come for free. Since the current has increased, supply voltages must be limited so that maximum power ratings are not exceeded.

Each amplifier in the EL2260C/EL2460C consume typically 7.5 mA and maximum 10.0 mA. The worst case power in an IC occurs when the output voltage is at half supply, if it can go that far, or its maximum value if it cannot reach half supply. If we assume that the EL2260C/EL2460C is used for double terminated video cable driving applications ( $R_L = 150\Omega$ ), and the gain = +2, then the maximum output voltage is 2V, and the average output voltage is 1.4V. If we set the two  $P_{Dmax}$  equations equal to each other, and solve for  $V_S$ , we can get a family of curves for various packages and conditions according to:

$$V_S = \frac{R_L * (T_{JMAX} - T_{AMAX})}{N * \theta_{JA}} + \frac{(V_{OUT})^2}{(2 * I_S * R_L) + V_{OUT}}$$

The following curve shows supply voltage ( $\pm V_S$ ) vs. temperature for the various packages assuming  $A_V = +2$ ,  $R_L = 150$ , and  $V_{OUT}$  peak = 2V. The curves include worst case conditions ( $I_S = 10$  mA and all amplifiers operating at  $V_{OUT}$  peak = 2V).

**Supply Voltage vs Ambient Temperature for All Packages of EL2260C/EL2460C**

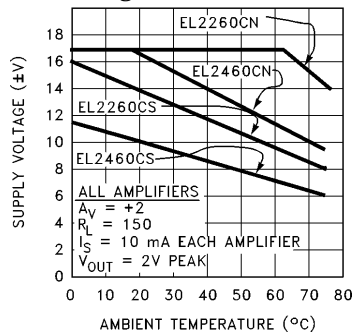

The curves do not include heat removal or forcing air, or the simple fact that the package will probably be attached to a circuit board, which can also provide some form of heat removal. Larger temperature and voltage ranges are possible with heat removal and forcing air past the part.

### Current Limit

The EL2260C/EL2460C have internal current limits that protect the circuit in the event of the output being shorted to ground. This limit is set at 100 mA nominally and reduces with junction temperature. At a junction temperature of 150°C, the current limits at about 65 mA. If any one output is shorted to ground, the power dissipation could be well over 1W, and much greater if all outputs are shorted. Heat removal is required in order for the EL2260C/EL2460C to survive an indefinite short.

### Channel to Channel Isolation

Due to careful biasing connections within the internal circuitry of the EL2260C/EL2460C, exceptionally good channel to channel isolation is obtained. Isolation is over 70 dB at video frequencies of 4 MHz, and over 65 dB up to 10 MHz. The EL2460C isolation is improved an additional 10 dB, up to about 5 MHz, for amplifiers A to B and amplifiers C to D. Isolation is improved another 8 dB for amplifiers A to C and amplifiers B to D. See the curve in the Typical Performance Curves section for more detail.

### Driving Cables and Capacitive Loads

When used as a cable driver, double termination is always recommended for reflection-free performance. For those applications, the back termination series resistor will decouple the EL2260C and EL2460C from the capacitive cable and allow extensive capacitive drive. However, other applications may have high capacitive loads without termination resistors. In these applications, an additional small value (5Ω–50Ω) resistor in series with the output will eliminate most peaking. The gain resistor,  $R_G$ , can be chosen to make up for the gain loss created by this additional series resistor at the output.

2260-14

# *EL2260C/EL2460C*

## *Dual/Quad 130 MHz Current Feedback Amplifiers*

### EL2260C/EL2460C Macromodel

```

* Revision A, March 1993
* AC Characteristics used CIN- (pin 2) = 1 pF; RF = 560Ω
* Connections:
*
*      + input
*      |
*      | - input
*      |
*      | + Vsupply
*      | |
*      | | - Vsupply
*      | |
*      | | output
*      | |
*      | |
*
.subckt EL2260C/EL 3 2 7 4 6
*
* Input Stage
*
e1 10 0 3 0 1.0
vis 10 9 0V
h2 9 12 vxx 1.0
r1 2 11 130
l1 11 12 25nH
iinp 3 0 0.5μA
iinm 2 0 5μA
r12 3 0 2Meg
*
* Slew Rate Limiting
*
h1 13 0 vis 600
r2 13 14 1K
d1 14 0 dclamp
d2 0 14 dclamp
*
* High Frequency Pole
*
*e2 30 0 14 0 0.001666666666
l3 30 17 0.43μH
c5 17 0 0.27pF
r5 17 0 500
*
* Transimpedance Stage
*
g1 0 18 17 0 1.0
ro1 18 0 2Meg
cdp 18 0 2.285pF
*
* Output Stage
*
q1 4 18 19 qp
q2 7 18 20 qn
q3 7 19 21 qn
q4 4 20 22 qp
r7 21 6 4
r8 22 6 4
ios1 7 19 2mA
ios2 20 4 2mA
*

```

# EL2260C/EL2460C

## Dual/Quad 130 MHz Current Feedback Amplifiers

### EL2260C/EL2460C Macromodel — Contd.

\* Supply Current

\*

ips 7 4 2mA

\*

\* Error Terms

\*

ivos 0 23 2mA

vxx 23 0 0V

e4 24 0 3 0 1.0

e5 25 0 7 0 1.0

e6 26 0 4 0 1.0

r9 24 23 562

r10 25 23 1K

r11 26 23 1K

\*

\* Models

\*

.model qn npn (is = 5e-15 bf = 100 tf = 0.1ns)

.model qp pnp (is = 5e-15 bf = 100 tf = 0.1ns)

.model dclamp d (is = 1e-30 ibv = 0.266 bv = 2.24 n = 4)

.ends

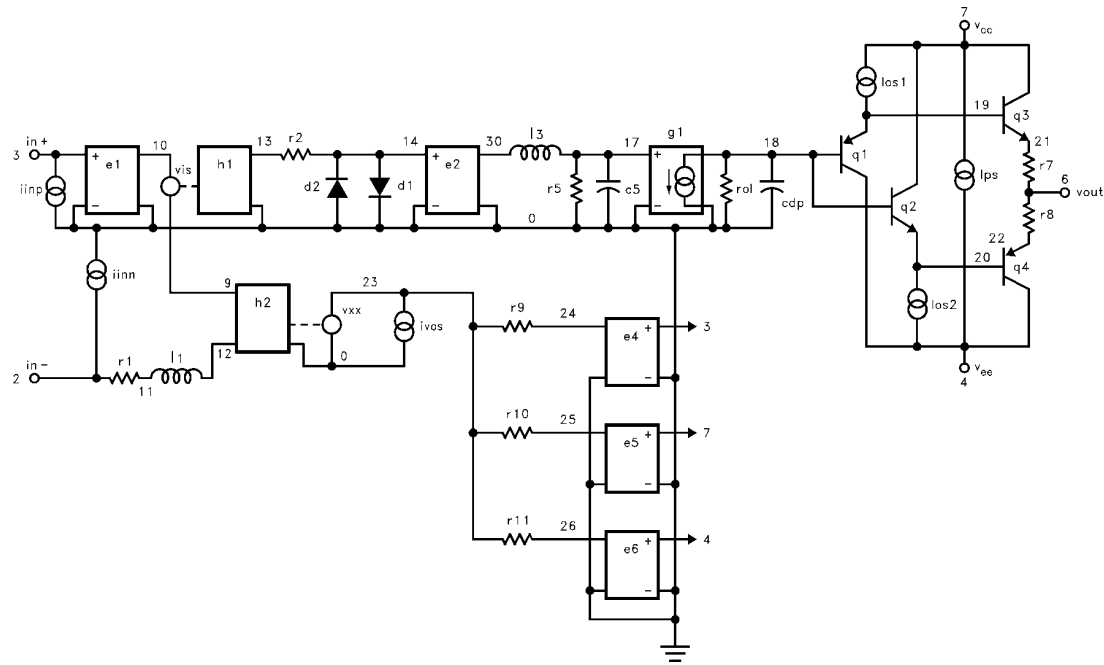

2260-15



BLANK

**BLANK**

**BLANK**

# ***EL2260C/EL2460C***

## ***Dual/Quad 130 MHz Current Feedback Amplifiers***

### **General Disclaimer**

Specifications contained in this data sheet are in effect as of the publication date shown. Elantec, Inc. reserves the right to make changes in the circuitry or specifications contained herein at any time without notice. Elantec, Inc. assumes no responsibility for the use of any circuits described herein and makes no representations that they are free from patent infringement.

***élantec***  
HIGH PERFORMANCE ANALOG INTEGRATED CIRCUITS

### **Elantec, Inc.**

1996 Tarob Court

Milpitas, CA 95035

Telephone: (408) 945-1323

(800) 333-6314

Fax: (408) 945-9305

European Office: 44-71-482-4596

### **WARNING — Life Support Policy**

Elantec, Inc. products are not authorized for and should not be used within Life Support Systems without the specific written consent of Elantec, Inc. Life Support systems are equipment intended to support or sustain life and whose failure to perform when properly used in accordance with instructions provided can be reasonably expected to result in significant personal injury or death. Users contemplating application of Elantec, Inc. products in Life Support Systems are requested to contact Elantec, Inc. factory headquarters to establish suitable terms & conditions for these applications. Elantec, Inc.'s warranty is limited to replacement of defective components and does not cover injury to persons or property or other consequential damages.