



# M80287 80-BIT HMOS\* NUMERIC PROCESSOR EXTENSION

*Military*

- High Performance 80-Bit Internal Architecture
- Implements Proposed IEEE Floating Point Standard 754
- Expands M80286/10 Datatypes to Include 32-, 64-, 80-Bit Floating Point, 32-, 64-Bit Integers and 18-Digit BCD Operands
- Object Code Compatible with M8087
- Built-In Exception Handling
- Operates in Both Real and Protected Mode M80286 Systems
- Available in a 40-Pin Cerdip Package
- Protected Mode Operation Completely Conforms to the M80286 Memory Management and Protection Mechanisms
- Directly Extends M80286/10 Instruction Set to Trigonometric, Logarithmic, Exponential and Arithmetic Instructions for All Datatypes
- 8 x 80-Bit, Individually Addressable, Numeric Register Stack
- 6, 8, 10 MHz
- Military Temperature Range:  $-55^{\circ}\text{C}$  to  $+125^{\circ}\text{C}$  ( $T_C$ )

The Intel M80287 is a high performance numerics processor extension that extends the M80286/10 architecture with floating point, extended integer and BCD data types. The M80286/20 computing system (M80286 and M80287) fully conforms to the proposed IEEE Floating Point Standard. Using a numerics oriented architecture, the M80287 adds over fifty mnemonics to the M80286/20 instruction set, making the M80286/20 a complete solution for high performance numeric processing. The M80287 is implemented in N-channel, depletion load, silicon gate technology (HMOS) and packaged in a 40-pin ceramic package. The M80286/20 is object code compatible with the M80286/20 and M8088/20. Intel's HMOS III process provides superior radiation tolerance for applications with stringent radiation requirements.

\*HMOS is a patented process of Intel Corporation.

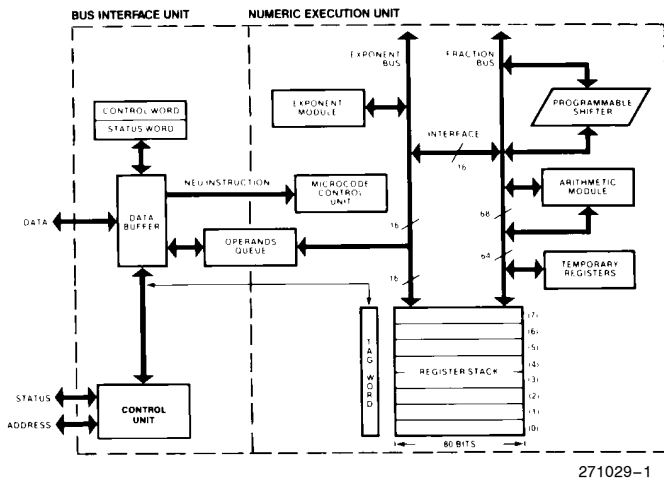
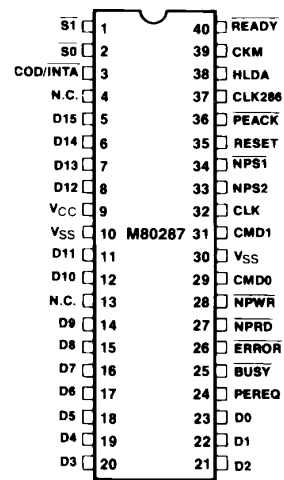

Figure 1. M80287 Block Diagram



NOTE:  
N.C. pins must not be connected.

Figure 2. M80287 Pin Configuration

**Table 1. M80287 Pin Description**

Symbol	Type	Name and Function
CLK	I	<b>CLOCK INPUT:</b> This clock provides the basic timing for internal M80287 operations. Special MOS level inputs are required. The M82284 or M8284A CLK outputs are compatible to this input.
CKM	I	<b>CLOCK MODE SIGNAL:</b> Indicates whether CLK input is to be divided by 3 or used directly. A HIGH input will select the latter option. This input may be connected to V <sub>CC</sub> or V <sub>SS</sub> as appropriate. This input must be either HIGH or LOW 20 CLK cycles before RESET goes LOW.
RESET	I	<b>SYSTEM RESET:</b> Causes the M80287 to immediately terminate its present activity and enter a dormant state. RESET is required to be HIGH for more than 4 M80287 CLK cycles. For proper initialization the HIGH-LOW transition must occur no sooner than 50 μs after V <sub>CC</sub> and CLK meet their D.C. and A.C. specifications.
D15–D0	I/O	<b>DATA:</b> 16-bit bidirectional data bus. Inputs to these pins may be applied asynchronous to the M80287 clock.
BUSY	O	<b>BUSY STATUS:</b> Asserted by the M80287 to indicate that it is currently executing a command.
ERROR	O	<b>ERROR STATUS:</b> Reflects the ES bit of the status word. This signal indicates that an unmasked error condition exists.
PEREQ	O	<b>PROCESSOR EXTENSION DATA CHANNEL OPERAND TRANSFER REQUEST:</b> A HIGH on this output indicates that the M80287 is ready to transfer data. PEREQ will be disabled upon assertion of PEACK or upon actual data transfer, whichever occurs first, if no more transfers are required.
PEACK	I	<b>PROCESSOR EXTENSION DATA CHANNEL OPERAND TRANSFER ACKNOWLEDGE:</b> Acknowledges that the request signal (PEREQ) has been recognized. Will cause the request (PEREQ) to be withdrawn in case there are no more transfers required. PEACK may be asynchronous to the M80287 clock.
NPRD	I	<b>NUMERIC PROCESSOR READ:</b> Enables transfer of data from the M80287. This input may be asynchronous to the M80287 clock.
NPWR	I	<b>NUMERIC PROCESSOR WRITE:</b> Enables transfer of data to the M80287. This input may be asynchronous to the M80287 clock.
NPS1, NPS2	I	<b>NUMERIC PROCESSOR SELECTS:</b> Indicates the CPU is performing an ESCAPE instruction. Concurrent assertion of these signals (i.e., NPS1 is LOW and NPS2 is HIGH) enables the M80287 to perform floating point instructions. No data transfers involving the M80287 will occur unless the device is selected via these lines. These inputs may be asynchronous to the M80287 clock.
CMD1, CMD0	I	<b>COMMAND LINES:</b> These, along with select inputs, allow the CPU to direct the operation of the M80287. No actions will occur if these signals are both HIGH. These inputs may be asynchronous to the M80287 clock.
CLK286	I	<b>CPU CLOCK:</b> This input provides a sampling edge for the M80287 inputs S1, S0, COD/INTA, READY, and HLDA. It must be connected to the M80286 CLK input.
S1, S0 COD/INTA	I	<b>STATUS:</b> These inputs allow the M80287 to monitor the execution of ESCAPE instructions by the M80286. They must be connected to the corresponding M80286 pins.
HLDA	I	<b>HOLD ACKNOWLEDGE:</b> This input informs the M80287 when the M80286 controls the local bus. It must be connected to the M80286 HLDA output.
READY	I	<b>READY:</b> The end of a bus cycle is signaled by this input. It must be connected to the M80286 READY input.
V <sub>SS</sub>	I	<b>GROUND:</b> System ground, both pins must be connected to ground.
V <sub>CC</sub>	I	<b>POWER:</b> +5V supply.



## FUNCTIONAL DESCRIPTION

The M80287 Numeric Processor Extension (NPX) provides arithmetic instructions for a variety of numeric data types in M80286/20 systems. It also executes numerous built-in transcendental functions (e.g., tangent and log functions). The M80287 executes instructions in parallel with an M80286. It effectively extends the register and instruction set of an M80286/10 system for existing M80286 data types and adds several new data types as well. Figure 3 presents the program visible register model of the M80286/20. Essentially, the M80287 can be treated as an additional resource or an extension to the M80286/10 that can be used as a single unified system, the M80286/20.

The M80287 has two operating modes similar to the two modes of the M80286. When reset, M80287 is in the real address mode. It can be placed in the protected virtual address mode by executing the SETPM ESC instruction. The M80287 cannot be switched back to the real address mode except by reset. In the real address mode, the M80286/20 is completely software compatible with M8086, 88/20.

Once in protected mode, all references to memory for numeric data or status information, obey the M80286 memory management and protection rules giving a fully protected extension of the M80286 CPU. In the protected mode, M80286/20 numeric software is also completely compatible with M8086/20 and M8088/20.

The M80287 has two operating modes similar to the two modes of the M80286. When reset, M80287 is in the real address mode. It can be placed in the protected virtual address mode by executing the SETPM ESC instruction. The M80287 cannot be switched back to the real address mode except by reset. In the real address mode, the M80286/M80287 is completely software compatible with M8086/M8087 and M8088/M8087.

Once in protected mode, all references to memory for numeric data or status information, obey the M80286 memory management and protection rules giving a fully protected extension of the M80286 CPU. In the protected mode, M80286/M80287 numeric software is also completely compatible with M8086/M8087 and M8088/M8087.

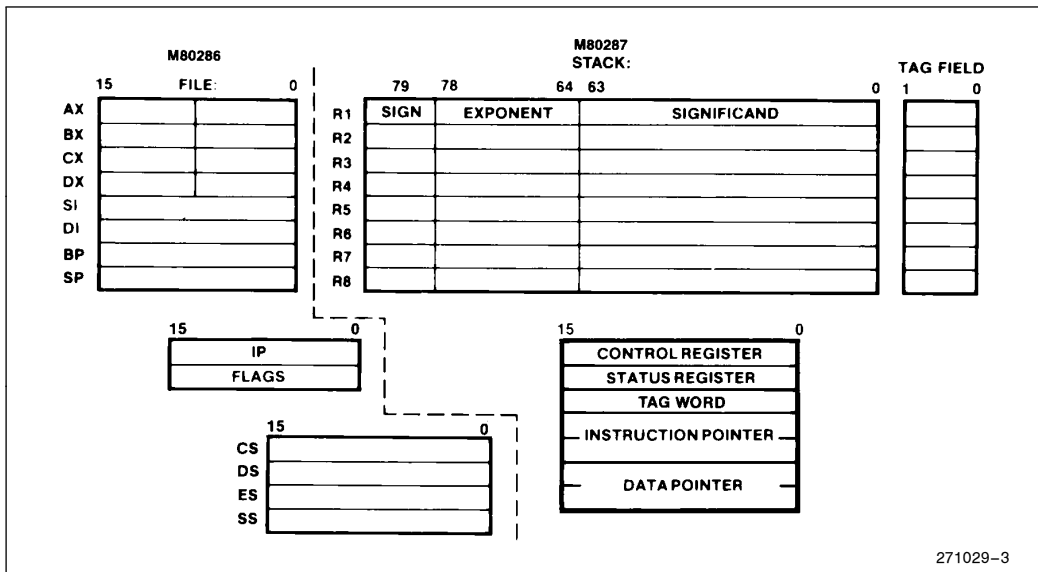

Figure 3. M80286/20 Architecture

M80287

### ABSOLUTE MAXIMUM RATINGS\*

Storage Temperature under Bias -65°C to +150°C  
 Case Temperature ..... -55°C to +125°C  
 Voltage on any Pin with  
 Respect to Ground ..... -1.0 to +7V  
 Power Dissipation ..... 3.0 Watt

NOTICE: This is a production data sheet. The specifications are subject to change without notice.

\*WARNING: Stressing the device beyond the "Absolute Maximum Ratings" may cause permanent damage. These are stress ratings only. Operation beyond the "Operating Conditions" is not recommended and extended exposure beyond the "Operating Conditions" may affect device reliability.

### Operating Conditions

Symbol	Description	Min	Max	Units
T <sub>C</sub>	Case Temperature (Instant On)	-55	+125	°C
V <sub>CC</sub>	Digital Supply Voltage	4.75	5.25	V

### D.C. CHARACTERISTICS (Over Specified Operating Conditions)

Symbol	Parameter	Min	Max	Unit	Test Conditions
V <sub>IL</sub>	Input LOW Voltage	-0.5	0.8	V	
V <sub>IH</sub>	Input HIGH Voltage	2.0	V <sub>CC</sub> + 0.5	V	
V <sub>ILC</sub>	Clock Input LOW Voltage CKM = 1: CKM = 0:	2.0	V <sub>CC</sub> + 1	V	
		3.8	V <sub>CC</sub> + 1	V	
V <sub>OL</sub>	Output LOW Voltage		0.45	V	I <sub>OL</sub> = 3.0 mA
V <sub>OH</sub>	Output HIGH Voltage	2.4		V	I <sub>OH</sub> = -400 μA
I <sub>LI</sub>	Input Leakage Current		±10	μA	0V ≤ V <sub>IN</sub> ≤ V <sub>CC</sub>
I <sub>LO</sub>	Output Leakage Current		±10	μA	0.45V ≤ V <sub>OUT</sub> ≤ V <sub>CC</sub>
I <sub>CC</sub>	Power Supply Current		600	mA	T <sub>C</sub> = -55°C
C <sub>IN</sub>	Input Capacitance		10	pF	F <sub>C</sub> = 1 MHz
C <sub>O</sub>	Input/Output Capacitance (D0-D15)		20	pF	F <sub>C</sub> = 1 MHz
C <sub>CLK</sub>	CLK Capacitance		12	pF	F <sub>C</sub> = 1 MHz



## A.C. CHARACTERISTICS (Over Specified Operating Conditions)

### TIMING REQUIREMENTS

A.C. timings are referenced to 0.8V and 2.0V points on signals unless otherwise noted.

Symbol	Parameter	6 MHz		8 MHz		10 MHz		Unit	Comments
		-6 Min	-6 Max	-8 Min	-8 Max	-10 Min	-10 Max		
T <sub>CLCL</sub>	CLK Period CKM = 1 CKM = 0	165	500	125	500	100	500	ns	
		62.5	166	50	166	40	166	ns	
T <sub>CLCH</sub>	CLK LOW Time CKM = 1 CKM = 0	100	343	68	343	53	343	ns	At 0.8V
		15	146	15	146	11	146	ns	At 0.6V
T <sub>CHCL</sub>	CLK HIGH Time CKM = 1 CKM = 0	50	230	43	230	28	230	ns	At 2.0V
		20	151	20	151	18	151	ns	At 3.6V
T <sub>CH1CH2</sub>	CLK Rise Time		10		10		10	ns	1.0V to 3.6V if CKM = 1
T <sub>CL2CL1</sub>	CLK Fall Time		10		10		10	ns	3.6V to 1.0V if CKM = 1
T <sub>DVWH</sub>	Data Setup to $\overline{\text{NPWR}}$ Inactive	75		75		75		ns	
T <sub>WHDX</sub>	Data Hold from $\overline{\text{NPWR}}$ Inactive	30		18		18		ns	
T <sub>WLWH</sub> T <sub>RLRH</sub>	$\overline{\text{NPWR}}$ $\overline{\text{NPRD}}$ Active Time	95		90		90		ns	At 0.8V
T <sub>AVRL</sub> T <sub>AVWL</sub>	Command Valid to $\overline{\text{NPWR}}$ or $\overline{\text{NPRD}}$ Active	0		0		0		ns	
T <sub>MHRL</sub>	Minimum Delay from PEREQ Active to $\overline{\text{NPRD}}$ Active	130		130		100		ns	
T <sub>KLKH</sub>	$\overline{\text{PEAK}}$ Active Time	85		85		60		ns	At 0.8V
T <sub>KHKL</sub>	$\overline{\text{PEAK}}$ Inactive Time	250		250		200		ns	At 2.0V
T <sub>KHCH</sub>	$\overline{\text{PEAK}}$ Inactive to $\overline{\text{NPWR}}$ , $\overline{\text{NPRD}}$ Inactive	50		40		40		ns	
T <sub>CHKL</sub>	$\overline{\text{NPWR}}$ $\overline{\text{NPRD}}$ Inactive to $\overline{\text{PEAK}}$ Inactive	-30		-30		-30		ns	
T <sub>WHAX</sub> T <sub>RHAX</sub>	Command Hold from $\overline{\text{NPWR}}$ $\overline{\text{NPRD}}$ Inactive	30		30		22		ns	
T <sub>KLCL</sub>	$\overline{\text{PEAK}}$ Active Setup to $\overline{\text{NPWR}}$ $\overline{\text{NPRD}}$ Active	50		40		40		ns	
T <sub>IVCL</sub>	$\overline{\text{NPWR}}$ , $\overline{\text{NPRD}}$ , RESET to CLK Setup Time	70		70		53		ns	
T <sub>CLIH</sub>	$\overline{\text{NPWR}}$ , $\overline{\text{NPRD}}$ , RESET from CLK Hold Time	45		45		37		ns	
T <sub>RSCL</sub>	RESET to CLK Setup Time	20		20		20		ns	
T <sub>CLRS</sub>	RESET from CLK Hold Time	20		20		20		ns	

#### NOTE:

T<sub>ja</sub> = 41°C/W

T<sub>jc</sub> = 14°C/W

M80287

**A.C. CHARACTERISTICS** (Over Specified Operating Conditions)**TIMING RESPONSES**

Symbol	Parameter	6 MHz		8 MHz		10 MHz		Unit	Comments
		-6 Min	-6 Max	-8 Min	-8 Max	-10 Min	-10 Max		
T <sub>RHQZ</sub>	$\overline{\text{NPRD}}$ Inactive to Data Float		37.5		35		25	ns	(Note 2)
T <sub>RLQV</sub>	$\overline{\text{NPRD}}$ Active to Data Valid		60		60		60	ns	(Note 3)
T <sub>ILBH</sub>	$\overline{\text{ERROR}}$ Active to $\overline{\text{BUSY}}$ Inactive	100		100		100		ns	(Note 4)
T <sub>WLBV</sub>	$\overline{\text{NPWR}}$ Active to $\overline{\text{BUSY}}$ Active		100		100		100	ns	(Note 5)
T <sub>KLML</sub>	$\overline{\text{PEACK}}$ Active to PEREQ Inactive		127		127		127	ns	(Note 6)
T <sub>CMDI</sub>	Command Inactive Time								
	Write-to-Write	95		95		75		ns	At 2.0V
	Read-to-Read	95		95		75		ns	At 2.0V
	Write-to-Read	95		95		75		ns	At 2.0V
T <sub>RHCH</sub>	Read-to-Write	95		95		75		ns	At 2.0V
	Data Hold from $\overline{\text{NPRD}}$ Inactive	3		3		3		ns	(Note 7)

**NOTES:**

2. Float condition occurs when output current is less than  $I_{LO}$  on D0–D15.
3. D0–D15 loading: CL = 100 pF.
4.  $\overline{\text{BUSY}}$  loading: CL = 100 pF.
5.  $\overline{\text{BUSY}}$  loading: CL = 100 pF.
6. On last data transfer of numeric instruction.
7. D0–D15 loading: CL = 100 pF.



WAVEFORMS

DATA TRANSFER TIMING (Initiated by M80286)

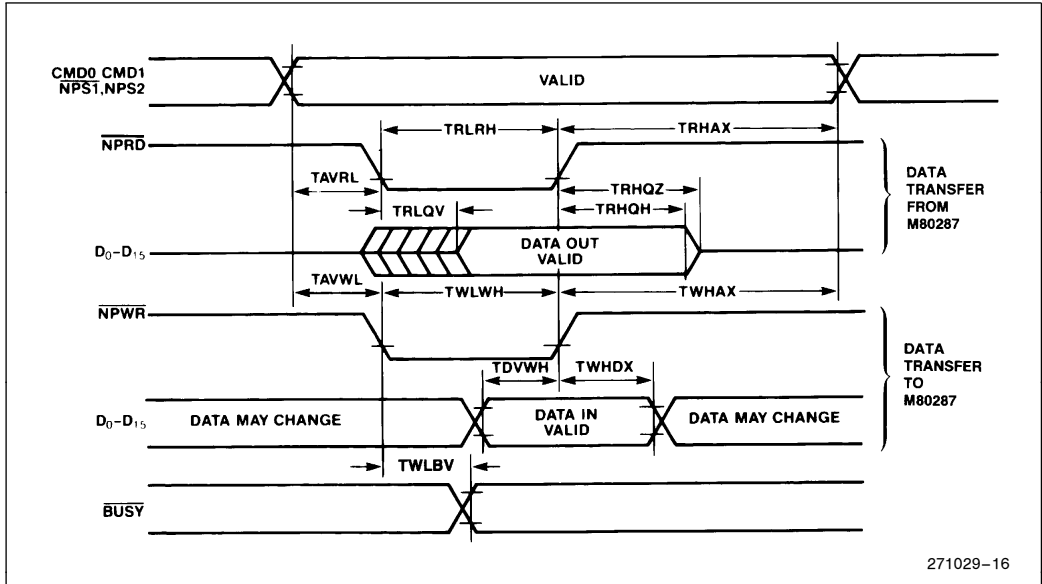

DATA CHANNEL TIMING (Initiated by M80287)

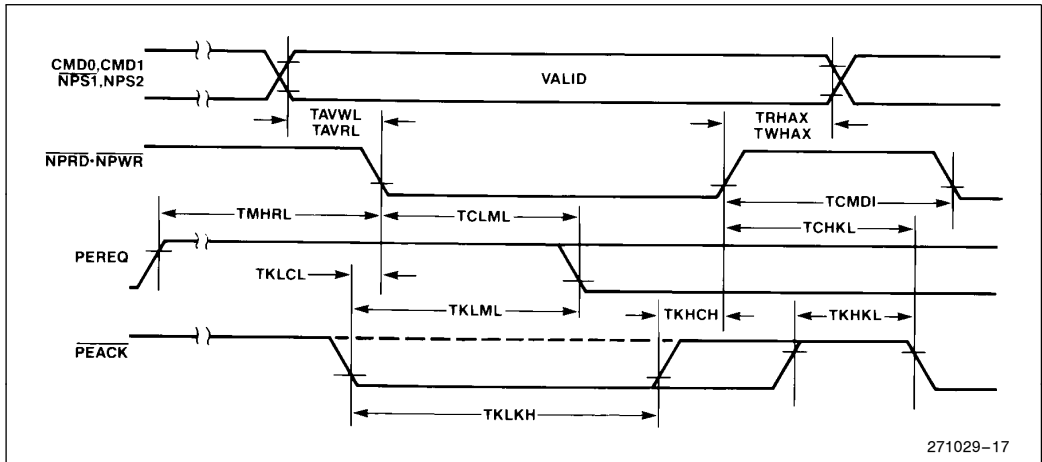

M80287

**WAVEFORMS** (Continued)

**ERROR OUTPUT TIMING**

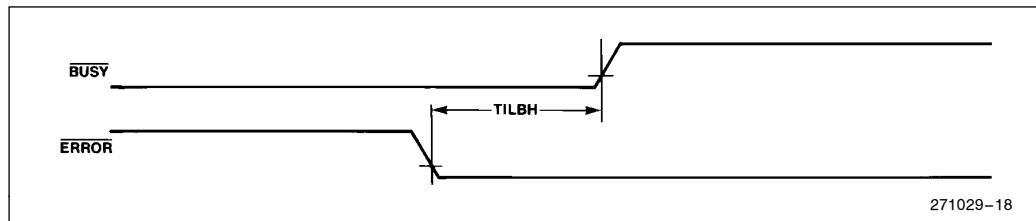

**CLK, RESET TIMING (CKM = 1)**

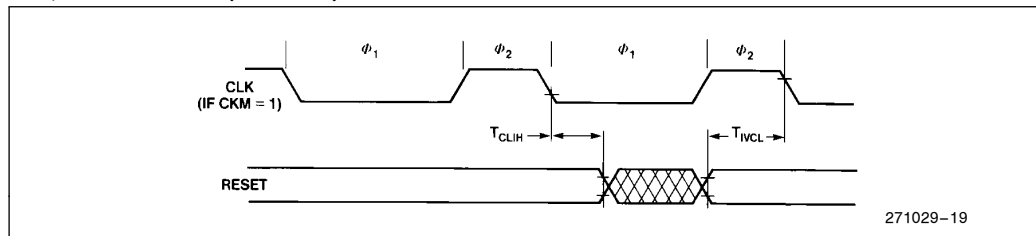

**NOTE:**

Reset,  $\overline{NPWR}$ ,  $\overline{NPRD}$  are inputs asynchronous to CLK. Timing requirements for **RESET**,  $\overline{NPWR}$ , and  $\overline{NPRD}$  are given for testing purposes only, to assure recognition at a specific CLK edge.



## WAVEFORMS (Continued)

### CLK, $\overline{\text{NPRD}}$ , $\overline{\text{NPWR}}$ TIMING (CKM = 1)

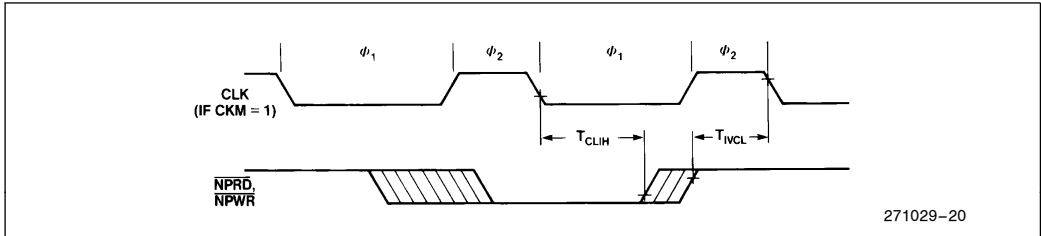

### CLK, RESET TIMING (CKM = 0)

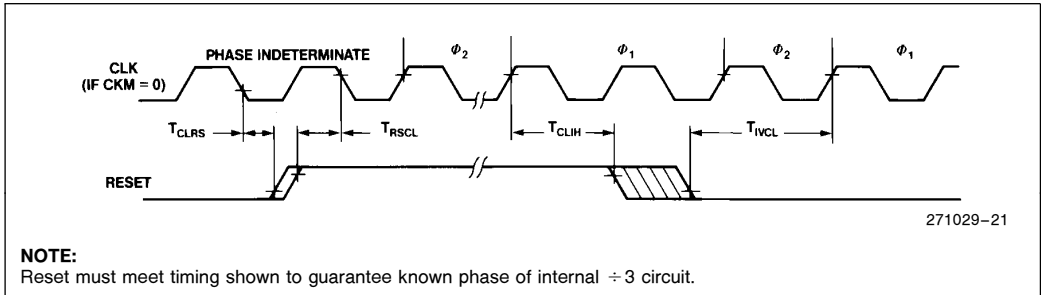

### CLK, $\overline{\text{NPRD}}$ , $\overline{\text{NPWR}}$ TIMING (CKM = 0)

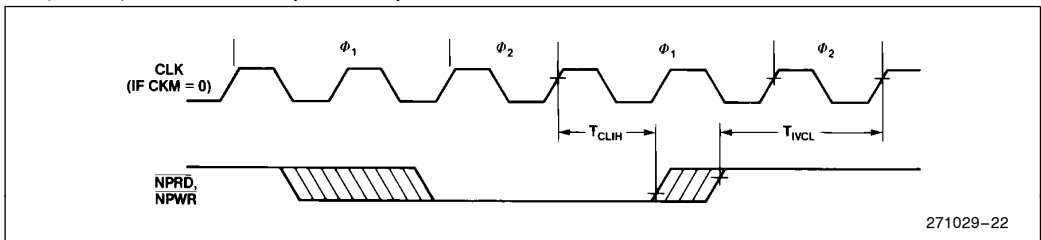

**NOTE:**

Reset,  $\overline{\text{NPWR}}$ ,  $\overline{\text{NPRD}}$  are inputs asynchronous to CLK. Timing requirements for RESET,  $\overline{\text{NPWR}}$ , and  $\overline{\text{NPRD}}$  are given for testing purposes only, to assure recognition at a specific CLK edge.

WAVEFORMS (Continued)

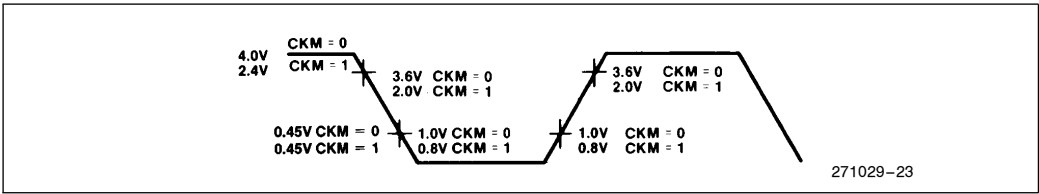

AC Drive and Measurement Points—CLK Input

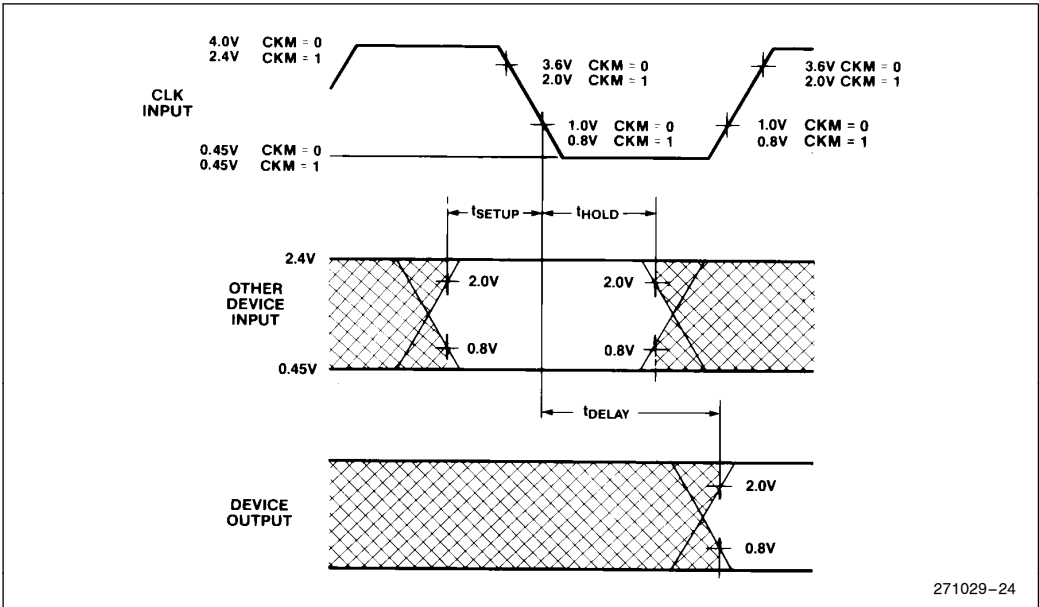

AC Setup, Hold and Delay Time Measurement—General

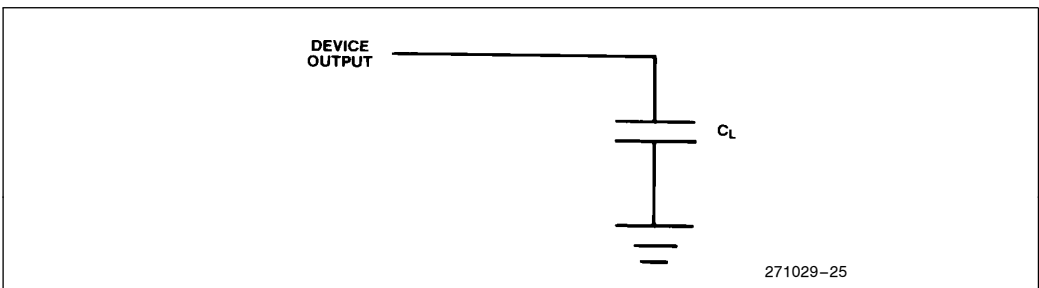

AC Test Loading on Outputs



## SYSTEM CONFIGURATION WITH M80286

As a processor extension to an M80286, the M80287 can be connected to the CPU as shown in Figure 4. The data channel control signals ( $\overline{\text{PEREQ}}$ ,  $\overline{\text{PEACK}}$ ), the  $\overline{\text{BUSY}}$  signal and the  $\overline{\text{NPRD}}$ ,  $\overline{\text{NPWR}}$  signals, allow the NPX to receive instructions and data from the CPU. When in the protected mode, all information received by the NPX is validated by the M80286 memory management and protection unit. Once started, the M80287 can process in parallel with and independent of the host CPU. When the NPX detects an error or exception, it will indicate this to the CPU by asserting the  $\overline{\text{ERROR}}$  signal.

The NPX uses the processor extension request and acknowledge pins of the M80286 CPU to implement data transfers with memory under the protection model of the CPU. The full virtual and physical address space of the M80286 is available. Data for the M80287 in memory is addressed and represented in the same manner as for an M8087.

The M80287 can operate either directly from the CPU clock or with a dedicated clock. For operation with the CPU clock ( $\text{CKM} = 0$ ), the M80287 works at one-third the frequency of the system clock (i.e., for an 8 MHz M80286, the 16 MHz system clock is divided down to 5.3 MHz). The M80287 provides a capability to internally divide the CPU clock by three to produce the required internal clock (33% duty cycle). To use a higher performance M80287 (8 MHz), an M8284A clock driver and appropriate crystal may be used to directly drive the M80287 with a  $\frac{1}{3}$  duty cycle clock on the CLK input ( $\text{CKM} = 1$ ).

## SYSTEM CONFIGURATION WITH M80386

The M80287 can also be connected as a processor extension to the M80386 CPU as shown in Figure 4b. All software written for M8086/M8087 and M80286/M80287 is object code compatible with 80386/M80287 and can benefit from the increased speed of the M80386 CPU.

Note that the  $\overline{\text{PEACK}}$  input pin is pulled high. This is because the M80287 is not required to keep track of the number of words transferred during an operand transfer when it is connected to the M80386 CPU. Unlike the M80286 CPU, the M80386 CPU knows the exact length of the operand being transferred to/from the M80287. After an ESC instruction has been sent to the M80287, the M80386 processor extension data channel will initiate the data transfer as soon as it receives the  $\overline{\text{PEREQ}}$  signal from the M80287. The transfer is automatically terminated by the M80386 CPU as soon as all the words of the operand have been transferred.

Because of the very high speed local bus of the M80386 CPU, the M80287 cannot reside directly on the CPU local bus. A local bus controller logic is used to generate the necessary read and write cycle timing as well as the chip select timings for the M80287. The M80386 CPU uses I/O addresses 800000F8 through 800000FF to communicate with the M80287. This is beyond the normal I/O address space of the CPU and makes it easier to generate the chip select signals using A31 and M/I $\overline{\text{O}}$ . It may also be noted that the M80386 CPU automatically generates 16-bit bus cycles whenever it communicates with the M80287.

## HARDWARE INTERFACE

Communication of instructions and data operands between the M80286 and M80287 is handled by the  $\overline{\text{CMD0}}$ ,  $\overline{\text{CMD1}}$ ,  $\overline{\text{NPS1}}$ ,  $\overline{\text{NPS2}}$ ,  $\overline{\text{NPRD}}$ , and  $\overline{\text{NPWR}}$  signals. I/O port addresses 00F8H, 00FAH, and 00FCH are used by the M80286 for this communication. When any of these addresses are used, the  $\overline{\text{NPS1}}$  input must be LOW and  $\overline{\text{NPS2}}$  input HIGH. The  $\overline{\text{I}^2\text{ORC}}$  and  $\overline{\text{I}^2\text{OWC}}$  outputs of the M82288 identify I/O space transfers (see Figure 4).  $\overline{\text{CMD0}}$  should be connected to latched M80286 A1 and  $\overline{\text{CMD1}}$  should be connected to latched M80286 A2.

I/O ports 00F8H to 00FFH are reserved for the M80286/M80287 interface. To guarantee correct operation of the M80287, programs must not perform any I/O operations to these ports.

The  $\overline{\text{PEREQ}}$ ,  $\overline{\text{PEACK}}$ ,  $\overline{\text{BUSY}}$ , and  $\overline{\text{ERROR}}$  signals of the M80287 are connected to the same-named M80286 input. The data pins of the M80287 should be directly connected to the M80286 data bus. Note that all bus drivers connected to the M80286 local bus must be inhibited when the M80286 reads from the M80287. The use of  $\overline{\text{COD/INTA}}$  and M/I $\overline{\text{O}}$  in the decoder prevents  $\overline{\text{INTA}}$  bus cycles from disabling the data transceivers.

The  $\overline{\text{S1}}$ ,  $\overline{\text{S0}}$ ,  $\overline{\text{COD/INTA}}$ ,  $\overline{\text{READY}}$ ,  $\overline{\text{HLDA}}$ , and CLK pins of the M80286 are connected to the same named pins on the M80287. These signals allow the M80287 to monitor the execution of ESCAPE instructions by the M80826.

## PROGRAMMING INTERFACE

Table 2 lists the seven data types the M80287 supports and presents the format for each type. These values are stored in memory with the least significant digits at the lowest memory address. Programs retrieve these values by generating the lowest address. All values should start at even addresses for maximum system performance.

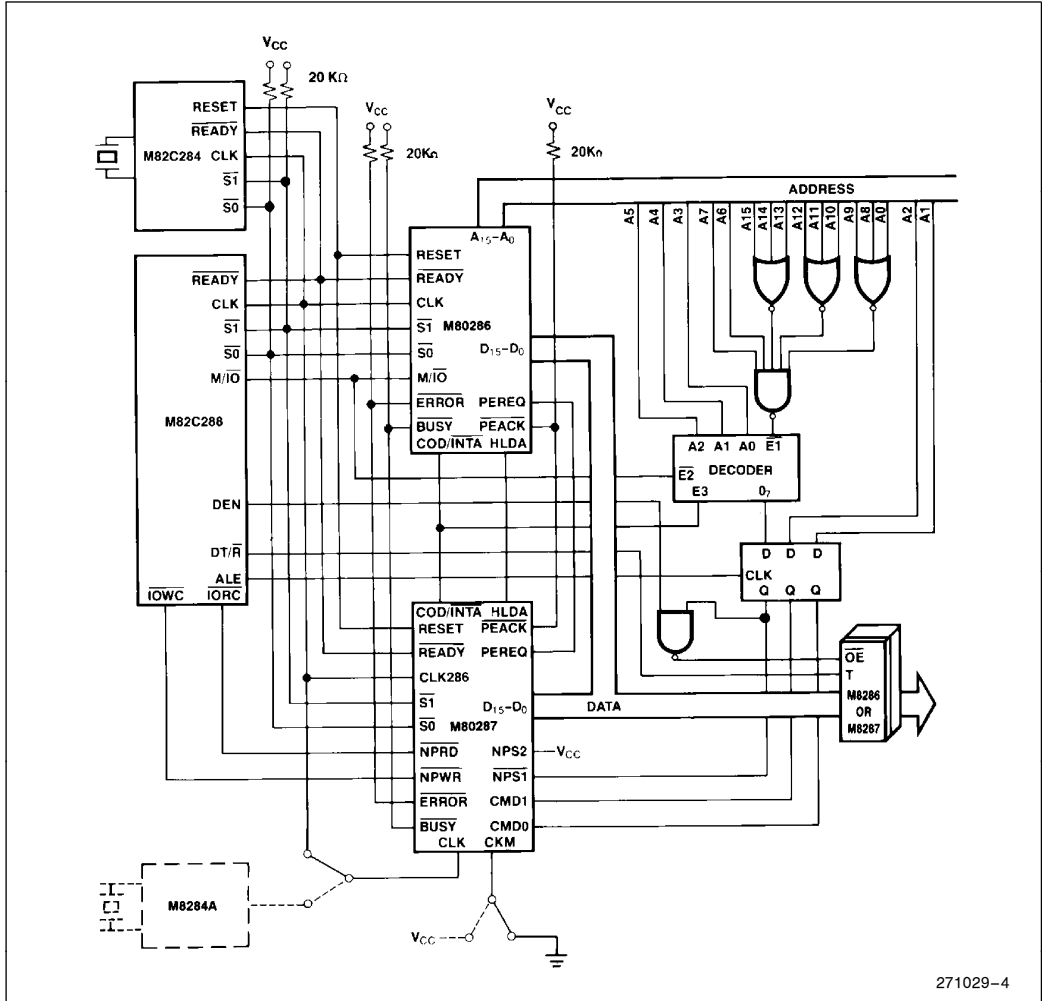

Figure 4. M80286/20 System Configuration

Internally the M80287 holds all numbers in the temporary real format. Load instructions automatically convert operands represented in memory as 16-, 32-, or 64-bit integers, 32- or 64-bit floating point numbers or 18-digit packed BCD numbers into temporary real format. Store instructions perform the reverse type conversion.

M80287 computations use the processor's register stack. These eight 80-bit registers provide the equivalent capacity of 40 16-bit registers. The M80287 register set can be accessed as a stack, with instructions operating on the top one or two stack elements, or as a fixed register set, with instructions operating on explicitly designated registers.

Table 6 lists the M80287's instructions by class. No special programming tools are necessary to use the M80287 since all new instructions and data types are directly supported by the M80286 assembler and appropriate high level languages. All M8086/88 development tools which support the M8087 can also be used to develop software for the M80286 in real address mode.

Table 3 gives the execution times of some typical numeric instructions.

Table 2. M80287 Datatype Representation in Memory

Data Formats	Range	Precision	Most Significant Byte				HIGHEST ADDRESSED BYTE																																																																																												
			7	0	7	0	7	0	7	0	7	0																																																																																							
Word Integer	$10^4$	16 Bits	[ ] (TWO'S COMPLEMENT)																																																																																																
Short Integer	$10^9$	32 Bits	[ ] (TWO'S COMPLEMENT)																																																																																																
Long Integer	$10^{19}$	64 Bits	[ ] (TWO'S COMPLEMENT)																																																																																																
Packed BCD	$10^{18}$	18 Digits	S	X	MAGNITUDE																																																																																														
Short Real	$10^{\pm 38}$	24 Bits	S	BIASED EXPONENT																			SIGNIFICAND																																																																												
Long Real	$10^{\pm 308}$	53 Bits	S	BIASED EXPONENT																																																SIGNIFICAND																																															
Temporary Real	$10^{\pm 4932}$	64 Bits	S	BIASED EXPONENT																																																												SIGNIFICAND																																			

271029-5

**NOTES:**

1. S = Sign bit (0 = positive, 1 = negative)
2.  $d_n$  = Decimal digit (two per byte)
3. X = Bits have no significance; M8087 ignores when loading, zeros when storing.
4. ▲ = Position of implicit binary point
5. I = Integer bit of significand; stored in temporary real, implicit in short and long real.
6. Exponent Bias (normalized values):  
Short Real: 127 (7FH)  
Long Real: 1023 (3FFH)  
Temporary Real: 16383 (3FFFH)
7. Packed BCD:  $(-1)^S (D_{17} \dots D_0)$
8. Real:  $(-1)^S (2^{E-BIAS}) (F_0 F_1 \dots)$

**SOFTWARE INTERFACE**

The M80286/20 is programmed as a single processor. All communication between the M80286 and the M80287 is transparent to software. The CPU automatically controls the M80287 whenever a numeric instruction is executed. All memory addressing modes, physical memory, and virtual memory of the CPU are available for use by the NPX.

Since the NPX operates in parallel with the CPU, any errors detected by the NPX may be reported after the CPU has executed the ESCAPE instruction which caused it. To allow identification of the failing numeric instruction, the NPX contains two pointer registers which identify the address of the failing numeric instruction and the numeric memory operand if appropriate for the instruction encountering this error.

**Table 3. Execution Time for Selected M80287 Instructions**

Floating Point Instruction	Approximate Execution Time ( $\mu\text{s}$ )
	M80287 (5 MHz Operation)
Add/Subtract	14/18
Multiply (Single Precision)	19
Multiply (Extended Precision)	27
Divide	39
Compare	9
Load (Double Precision)	10
Store (Double Precision)	21
Square Root	36
Tangent	90
Exponentiation	100

## INTERRUPT DESCRIPTION

Several interrupts of the M80286 are used to report exceptional conditions while executing numeric programs in either real or protected mode. The interrupts and their functions are shown in Table 4.

## PROCESSOR ARCHITECTURE

As shown in Figure 1, the NPX is internally divided into two processing elements, the bus interface unit (BIU) and the numeric execution unit (NEU). The NEU executes all numeric instructions, while the BIU receives and decodes instructions, requests operand transfers to and from memory and executes processor control instructions. The two units are able to operate independently of one another allowing the BIU to maintain asynchronous communication with the CPU while the NEU is busy processing a numeric instruction.

## BUS INTERFACE UNIT

The BIU decodes the ESC instruction executed by the CPU. If the ESC code defines a math instruction, the BIU transmits the formatted instruction to the NEU. If the ESC code defines an administrative instruction, the BIU executes it independently of the NEU. The parallel operation of the NPX with the CPU is normally transparent to the user. The BIU

generates the  $\overline{\text{BUSY}}$  and  $\overline{\text{ERROR}}$  signals for M80286/M80287 processor synchronization, and error notification, respectively.

The M80287 executes a single numeric instruction at a time. When executing most ESC instructions, the M80286 tests the BUSY pin and waits until the M80287 indicates that it is not busy before initiating the command. Once initiated, the M80286 continues program execution while the M80287 executes the ESC instruction. In M8086/20 systems, this synchronization is achieved by placing a WAIT instruction before an ESC instruction. For most ESC instructions, the M80286/20 does not require a WAIT instruction before the ESC opcode. However, the M80286/20 will operate correctly with these WAIT instructions. In all cases, a WAIT or ESC instruction should be inserted after any M80287 store to memory (except FSTSW and FSTCW) or load from memory (except FLDENV or FRSTOR) before the M80286 reads or changes the value.

Data transfers between memory and the M80287, when needed, are controlled by the PEREQ, PEACK, NPRD, NPWR, NPS1, NPS2 signals. The M80286 does the actual data transfer with memory through its processor extension data channel. Numeric data transfers with memory performed by the M80286 use the same timing as any other bus cycle. Control signals for the M80287 are generated by the M80286 as shown in Figure 4, and meet the timing requirements shown in the AC requirements section.



Table 4. Interrupt Vectors

Interrupt Number	Interrupt Function
7	An ESC instruction was encountered when EM or TS of the M80286 MSW was set. EM = 1 indicates that software emulation of the instruction is required. When TS is set, either an ESC or WAIT instruction will cause interrupt 7. This indicates that the current NPX context may not belong to the current task.
9	The second or subsequent words of a numeric operand in memory exceeded a segment's limit. This interrupt occurs after executing an ESC instruction. The saved return address will not point at the numeric instruction causing this interrupt. After processing the addressing error, the M80286 program can be restarted at the return address with IRET. The address of the failing numeric instruction and numeric operand are saved in the M80287. An interrupt handler for this interrupt <i>must</i> execute FNINIT before <i>any</i> other ESC or WAIT instruction.
13	The starting address of a numeric operand is not in the segment's limit. The return address will point at the ESC instruction (including prefixes) causing this error. The M80287 has not executed this instruction. The instruction and data address in M80287 refer to a previous, correctly executed, instruction.
16	The previous numeric instruction caused an unmasked numeric error. The address of the faulty numeric instruction or numeric data operand is stored in the M80287. Only ESC or WAIT instructions can cause this interrupt. The M80286 return address will point at a WAIT or ESC instruction, including prefixes, which may be restarted after clearing the error condition in the NPX.

## NUMERIC EXECUTION UNIT

The NEU executes all instructions that involve the register stack; these include arithmetic, logical, transcendental, constant and data transfer instructions. The data path in the NEU is 84 bits wide (68 fraction bits, 15 exponent bits and a sign bit) which allows internal operand transfers to be performed at very high speeds.

When the NEU begins executing an instruction, it activates the BIU BUSY signal. This signal is used in conjunction with the CPU WAIT instruction or automatically with most of the ESC instructions to synchronize both processors.

## REGISTER SET

The M80287 register set is shown in Figure 5. Each of the eight data registers in the M8087's register stack is 80 bits wide and is divided into "fields" corresponding to the NPX's temporary real data type.

At a given point in time the TOP field in the status word identifies the current top-of-stack register. A "push" operation decrements TOP by 1 and loads a value into the new top register. A "pop" operation stores the value from the current top register and then increments TOP by 1. Like M80286 stacks in memory, the M80287 register stack grows "down" toward lower-addressed registers.

Instructions may address the data registers either implicitly or explicitly. Many instructions operate on the register at the top of the stack. These instructions implicitly address the register pointed by the TOP. Other instructions allow the programmer to explicitly specify the register which is to be used. Explicit register addressing is "top-relative."

## Status Word

The 16-bit status word (in the status register) shown in Figure 6 reflects the overall state of the M80287. It may be read and inspected by CPU code. The busy bit (bit 15) indicates whether the NEU is executing an instruction (B = 1) or is idle (B = 0).

The instructions FSTSW, FSTENV, FSTSWAX and FSAVE which store the status word are executed exclusively by the BIU and do not set the busy bit themselves or require the Busy bit be cleared in order to be executed.

The four numeric condition code bits (C<sub>0</sub>–C<sub>3</sub>) are similar to the flags in a CPU: instructions that perform arithmetic operations update these bits to reflect the outcome of NDP operations. The effect of these instructions on the condition code bits is summarized in Tables 5a and 5b.





Bits 14–12 of the status word point to the M80287 register that is the current top-of-stack (TOP) as described above. Figure 6 shows the six error flags in bits 5–0 of the status word. Bits 5–0 are set to indicate that the NEU has detected an exception while executing an instruction. The section on exception handling explains how they are set and used.

Bit 7 is the error status bit. This bit is set if any unmasked exception bit is set and cleared otherwise. If this bit is set, the ERROR signal is asserted.

## Tag Word

The tag word marks the content of each register as shown in Figure 7. The principal function of the tag word is to optimize the NPX's performance. The tag word can be used, however, to interpret the contents of M80287 registers.

## Instruction and Data Pointers

The instruction and data pointers (see Figures 8a and 8b) are provided for user-written error handlers. Whenever the M80287 executes a new instruction, the BIU saves the instruction address, the operand address (if present) and the instruction opcode. M80287 instructions can store this data into memory.

The instruction and data pointers appear in one of two formats depending on the operating mode of the M80287. In real mode, these values are the 20-bit physical address and 11-bit opcode formatted like the M8087. In protected mode, these values are the 32-bit virtual addresses used by the program which executed an ESC instruction. The same FLDENV/FSTENV/FSAVE/FRSTOR instructions as those of the M8087 are used to transfer these values between the M80287 registers and memory.

**Table 5a. Condition Code Interpretation**

Instruction Type	C <sub>3</sub>	C <sub>2</sub>	C <sub>1</sub>	C <sub>0</sub>	Interpretation
Compare, Test	0	0	X	0	ST > Source or 0 (FTST)
	0	0	X	1	ST < Source or 0 (FTST)
	1	0	X	0	ST = Source or 0 (FTST)
	1	1	X	1	ST is not comparable
Remainder	Q <sub>1</sub>	0	Q <sub>0</sub>	Q <sub>2</sub>	Complete reduction with three low bits of quotient (See Table 5b)
	U	1	U	U	Incomplete Reduction
Examine	0	0	0	0	Valid, positive unnormalized
	0	0	0	1	Invalid, positive, exponent = 0
	0	0	1	0	Valid, negative, unnormalized
	0	0	1	1	Invalid, negative, exponent = 0
	0	1	0	0	Valid, positive, normalized
	0	1	0	1	Infinity, positive
	0	1	1	0	Valid, negative, normalized
	0	1	1	1	Infinity, negative
	1	0	0	0	Zero, positive
	1	0	0	1	Empty
	1	0	1	0	Zero, negative
	1	0	1	1	Empty
	1	1	0	0	Invalid, positive, exponent = 0
	1	1	0	1	Empty
	1	1	1	0	Invalid, negative, exponent = 0
	1	1	1	1	Empty

### NOTES:

1. ST = Top of stack
2. X = value is not affected by instruction
3. U = value is undefined following instruction
4. Q<sub>n</sub> = Quotient bit n

M80287

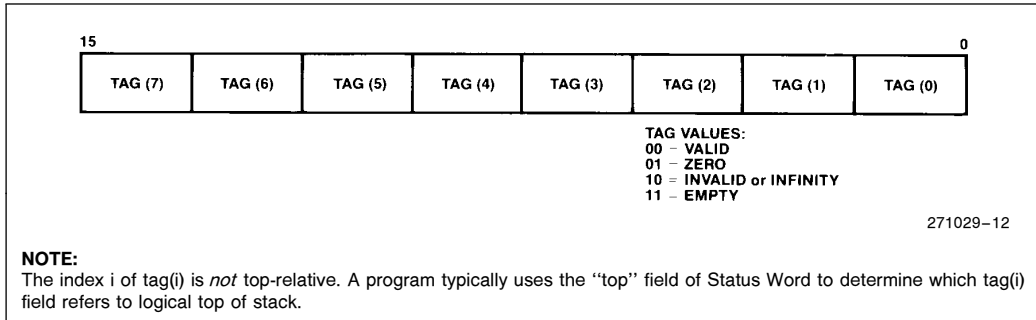

Figure 7. M80287 Tag Word

**Table 5b. Condition Code Interpretation After FPREM Instruction As a Function of Dividend Value**

Dividend Range	Q <sub>2</sub>	Q <sub>1</sub>	Q <sub>0</sub>
Dividend < 2 * Modulus	C <sub>3</sub>	C <sub>1</sub>	Q <sub>0</sub>
Dividend < 4 * Modulus	C <sub>3</sub>	Q <sub>1</sub>	Q <sub>0</sub>
Dividend ≥ 4 * Modulus	Q <sub>2</sub>	Q <sub>1</sub>	Q <sub>0</sub>

**NOTE:**

1. Previous value of indicated bit, not affected by FPREM instruction execution.

The saved instruction address in the M80287 will point at any prefixes which preceded the instruction. This is different than in the M8087 which only pointed at the ESCAPE instruction opcode.

**Control Word**

The NPX provides several processing options which are selected by loading a word from memory into the control word. Figure 9 shows the format and encoding of fields in the control word.

The low order byte of this control word configures the M80287 error and exception masking. Bits 5–0 of the control word contain individual masks for each of the six exceptions that the M80287 recognizes. The high order byte of the control word configures the M80287 operating mode including precision, rounding, and infinity control. The precision control bits (bits 9–8) can be used to set the M80287 internal operating precision at less than the default of temporary real (80-bit) precision. This can be useful in providing compatibility with the early generation arithmetic processors of smaller precision than the M80287. The rounding control bits (bits 11–10) provide for directed rounding and true chop as well as the unbiased round to nearest even mode specified in the IEEE standard. Control over closure of the

number space at infinity is also provided (either affine closure:  $\pm \infty$ , or projective closure:  $\infty$ , is treated as unsigned, may be specified).

**EXCEPTION HANDLING**

The M80287 detects six different exception conditions that can occur during instruction execution. Any or all exceptions will cause the assertion of ERROR signal if the appropriate exception masks are not set.

The exceptions that the M80287 detects and the ‘default’ procedures that will be carried out if the exception is masked, are as follows:

**Invalid Operation:** Stack overflow, stack underflow, indeterminate form (0/0,  $\infty - \infty$ , etc.) or the use of a Non-Number (NaN) as an operand. An exponent value of all ones and non-zero significand is reserved to identify NaNs. If this exception is masked, the M80287 default response is to generate a specific NaN called INDEFINITE, or to propagate already existing NaNs as the calculation result.

**Overflow:** The result is too large in magnitude to fit the specified format. The M80287 will generate an encoding for infinity if this exception is masked.

**Zero Divisor:** The divisor is zero while the dividend is a non-infinite, non-zero number. Again, the M80287 will generate an encoding for infinity if this exception is masked.

**Underflow:** The result is non-zero but too small in magnitude to fit in the specified format. If this exception is masked the M82087 will denormalize (shift right) the fraction until the exponent is in range. The process is called gradual underflow.

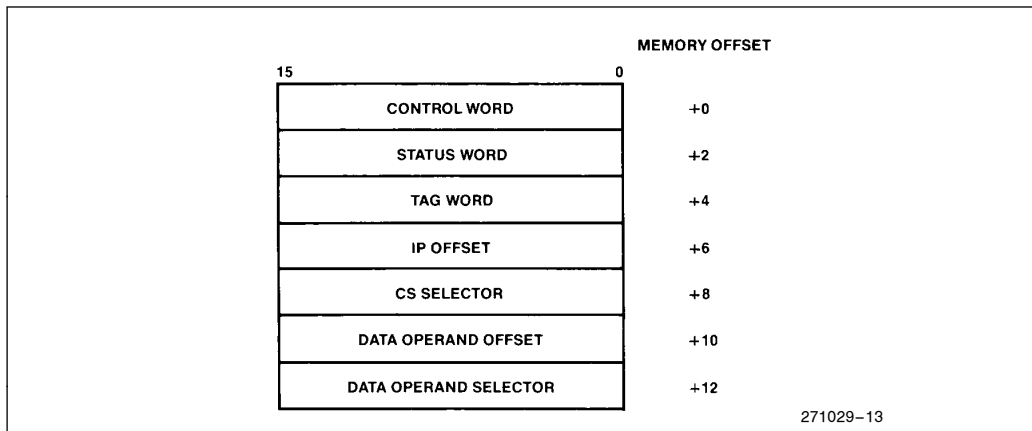

**Figure 8a. Protected Mode Instruction and Data Pointer Image in Memory**

**Denormalized Operand:** At least one of the operands is denormalized; it has the smallest exponent but a non-zero significand. Normal processing continues if this exception is masked off.

**Inexact Result:** If the true result is not exactly representable in the specified format, the result is rounded according to the rounding mode, and this flag is set. If this exception is masked, processing will simply continue.

If the error is not masked, the corresponding error bit and the error status bit (ES) in the control word will be set, and the `ERROR` output signal will be asserted. If the CPU attempts to execute another `ESC` or `WAIT` instruction, exception 7 will occur.

The error condition must be resolved via an interrupt service routine. The M80287 saves the address of the floating point instruction causing the error as well as the address of the lowest memory location of any memory operand required by that instruction.

## M8086/20 COMPATIBILITY

M80286/20 supports portability of M8086/20 programs when it is in the real address mode. However, because of differences in the numeric error handling techniques, error handling routines *may* need to be changed. The differences between an M80286/20 and M8086/20 are:

1. The NPX error signal does not pass through an interrupt controller (M8087 INT signal does).

Therefore, any interrupt controller oriented instructions for the M8086/20 may have to be deleted.

2. Interrupt vector 16 must point at the numeric error handler routine.

3. The saved floating point instruction address in the M80287 includes any leading prefixes before the `ESCAPE` opcode. The corresponding saved address of the M8087 does not include leading prefixes.

4. In protected mode, the format of the saved instruction and operand pointers is different than for the M8087. The instruction opcode is not saved—it must be read from memory if needed.

5. Interrupt 7 will occur when executing `ESC` instructions with either `TS` or `EM` of `MSW = 1`. If `TS` of `MSW = 1` then `WAIT` will also cause interrupt 7. An interrupt handler should be added to handle this situation.

6. Interrupt 9 will occur if the second or subsequent words of a floating point operand fall outside a segment's size. Interrupt 13 will occur if the starting address of a numeric operand falls outside a segment's size. An interrupt handler should be added to report these programming errors.

In the protected mode, M8086/20 application code can be directly ported via recompilation if the 286 memory protection rules are not violated.

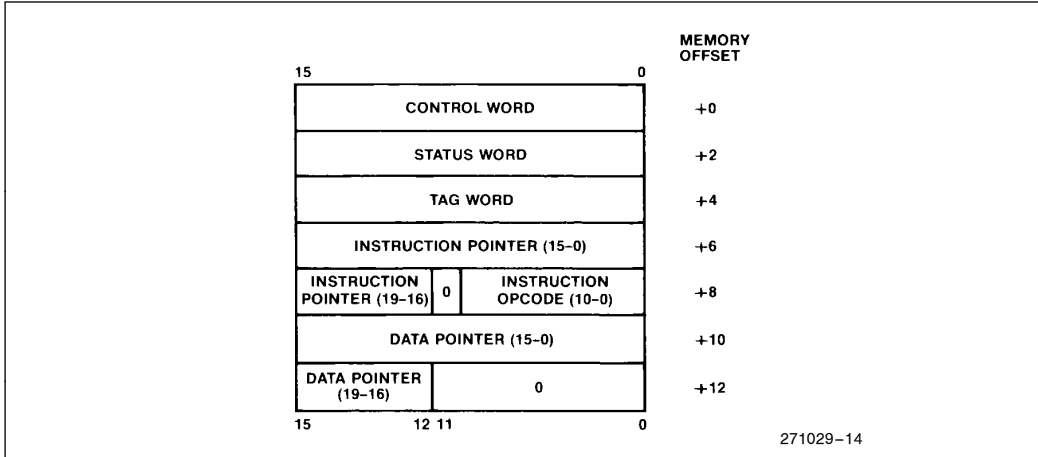

Figure 8b. Real Mode M80287 Instruction and Data Pointer Image in Memory

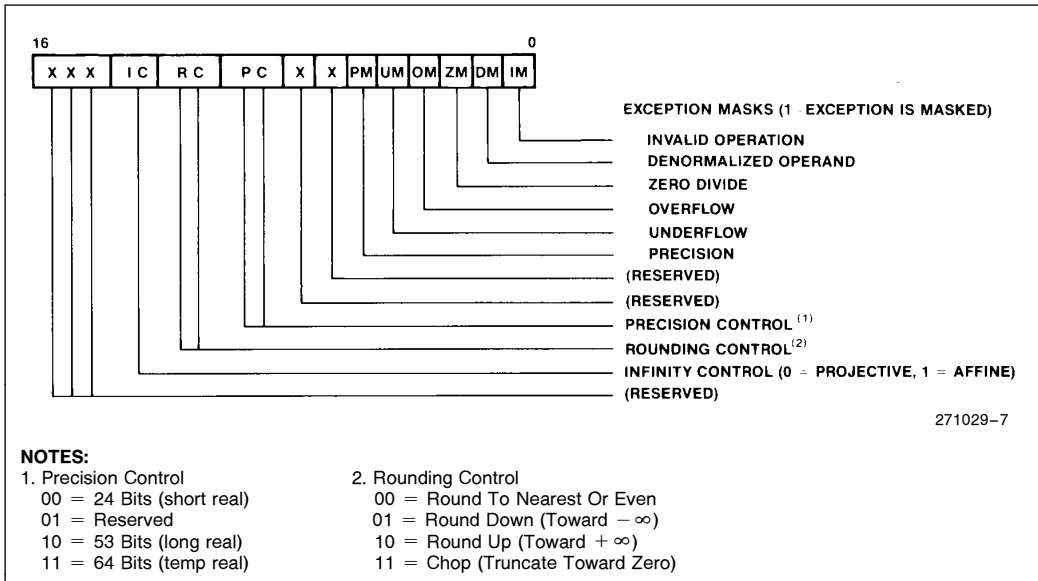

Figure 9. M80287 Control Word

Table 6. M80287 Extensions to the M80286 Instruction Set

Data Transfer	Optional 8,16 Bit Displacement	Clock Count Range			
		32 Bit Real	32 Bit Integer	64 Bit Real	16 Bit Integer
<b>FLD - LOAD</b>	MF	00	01	10	11
Integer/Real Memory to ST(0)	ESCAPE MF 1 MOD 0 0 0 R/M DISP	38-56	52-60	40-60	46-54
Long Integer Memory to ST(0)	ESCAPE 1 1 1 MOD 1 0 1 R/M DISP	60-68			
Temporary Real Memory to ST(0)	ESCAPE 0 1 1 MOD 1 0 1 R/M DISP	53-65			
BCD Memory to ST(0)	ESCAPE 1 1 1 MOD 1 0 0 R/M DISP	290-310			
ST(i) to ST(0)	ESCAPE 0 0 1 1 1 0 0 0 ST(i)	17-22			
<b>FST - STORE</b>					
ST(0) to Integer/Real Memory	ESCAPE MF 1 MOD 0 1 0 R/M DISP	84-90	82-92	96-104	80-90
ST(0) to ST(i)	ESCAPE 1 0 1 1 1 0 1 0 ST(i)	15-22			
<b>FSTP - STORE AND POP</b>					
ST(0) to Integer/Real Memory	ESCAPE MF 1 MOD 0 1 1 R/M DISP	86-92	84-94	98-106	82-92
ST(0) to Long Integer Memory	ESCAPE 1 1 1 MOD 1 1 1 R/M DISP	94-105			
ST(0) to Temporary Real Memory	ESCAPE 0 1 1 MOD 1 1 1 R/M DISP	52-58			
ST(0) to BCD Memory	ESCAPE 1 1 1 MOD 1 1 0 R/M DISP	520-540			
ST(0) to ST(i)	ESCAPE 1 0 1 1 1 0 1 1 ST(i)	17-24			
<b>FXCH - Exchange ST(i) and ST(0)</b>	ESCAPE 0 0 1 1 1 0 0 1 ST(i)	10-15			
<b>Comparison</b>					
<b>FCOM - Compare</b>					
Integer/Real Memory to ST(0)	ESCAPE MF 0 MOD 0 1 0 R/M DISP	60-70	78-91	65-75	72-86
ST(i) to ST(0)	ESCAPE 0 0 0 1 1 0 1 0 ST(i)	40-50			
<b>FCOMP - Compare and Pop</b>					
Integer/Real Memory to ST(0)	ESCAPE MF 0 MOD 0 1 1 R/M DISP	63-73	80-93	67-77	74-88
ST(i) to ST(0)	ESCAPE 0 0 0 1 1 0 1 1 ST(i)	45-52			
<b>FCOMPP = Compare ST(1) to ST(0) and Pop Twice</b>	ESCAPE 1 1 0 1 1 0 1 1 0 0 1	45-55			
<b>FTST = Test ST(0)</b>	ESCAPE 0 0 1 1 1 1 0 0 1 0 0	38-48			
<b>FXAM = Examine ST(0)</b>	ESCAPE 0 0 1 1 1 1 0 0 1 0 1	12-23			

Table 6. M80287 Extensions to the M80286 Instruction Set (Continued)

Constants	Optional 8,16 Bit Displacement		Clock Count Range			
	32 Bit Real	32 Bit Integer	64 Bit Real	16 Bit Integer		
	MF	—	00	01	10	11
<b>FLDZ</b> - LOAD + 0.0 into ST(0)	ESCAPE	0 0 1	1 1 1 0 1 1 1 0			11-17
<b>FLD1</b> - LOAD + 1.0 into ST(0)	ESCAPE	0 0 1	1 1 1 0 1 0 0 0			15-21
<b>FLDPI</b> - LOAD $\pi$ into ST(0)	ESCAPE	0 0 1	1 1 1 0 1 0 1 1			16-22
<b>FLDL2T</b> - LOAD $\log_2 10$ into ST(0)	ESCAPE	0 0 1	1 1 1 0 1 0 0 1			16-22
<b>FLDL2E</b> - LOAD $\log_2 e$ into ST(0)	ESCAPE	0 0 1	1 1 1 0 1 0 1 0			15-21
<b>FLDLG2</b> - LOAD $\log_{10} 2$ into ST(0)	ESCAPE	0 0 1	1 1 1 0 1 1 0 0			18-24
<b>FLDLN2</b> - LOAD $\log_e 2$ into ST(0)	ESCAPE	0 0 1	1 1 1 0 1 1 0 1			17-23
<b>Arithmetic</b>						
<b>FADD</b> - Addition						
Integer/Real Memory with ST(0)	ESCAPE	MF 0	MOD 0 0 0 R/M	DISP		90-120 108-143 95-125 102-137
ST(i) and ST(0)	ESCAPE	d P 0	1 1 0 0 0 ST(i)			70-100 (Note 1)
<b>FSUB</b> - Subtraction						
Integer/Real Memory with ST(0)	ESCAPE	MF 0	MOD 1 0 R R/M	DISP		90-120 108-143 95-125 102-137
ST(i) and ST(0)	ESCAPE	d P 0	1 1 1 0 R R/M			70-100 (Note 1)
<b>FMUL</b> - Multiplication						
Integer/Real Memory with ST(0)	ESCAPE	MF 0	MOD 0 0 1 R/M	DISP		110-125 130-144 112-168 124-138
ST(i) and ST(0)	ESCAPE	d P 0	1 1 0 0 1 R/M			90-145 (Note 1)
<b>FDIV</b> - Division						
Integer/Real Memory with ST(0)	ESCAPE	MF 0	MOD 1 1 R R/M	DISP		215-225 230-243 220-230 224-238
ST(i) and ST(0)	ESCAPE	d P 0	1 1 1 1 R R/M			193-203 (Note 1)
<b>FSQRT</b> - Square Root of ST(0)	ESCAPE	0 0 1	1 1 1 1 1 0 1 0			180-186
<b>FSCALE</b> - Scale ST(0) by ST(1)	ESCAPE	0 0 1	1 1 1 1 1 1 0 1			32-38
<b>FPREM</b> - Partial Remainder of ST(0) ÷ ST(1)	ESCAPE	0 0 1	1 1 1 1 1 0 0 0			15-190
<b>FRNDINT</b> - Round ST(0) to Integer	ESCAPE	0 0 1	1 1 1 1 1 1 0 0			16-50

271029-9

**NOTE:**

1. If P = 1 then add 5 clocks.

Table 6. M80287 Extensions to the M80286 Instruction Set (Continued)

		Optional 8,16 Bit Displacement	Clock Count Range	
<b>FTRACT</b> = Extract Components of ST(0)	ESCAPE 0 0 1	1 1 1 1 0 1 0 0	27-55	
<b>FABS</b> = Absolute Value of ST(0)	ESCAPE 0 0 1	1 1 1 0 0 0 0 1	10-17	
<b>FCHS</b> = Change Sign of ST(0)	ESCAPE 0 0 1	1 1 1 0 0 0 0 0	10-17	
<b>Transcendental</b>				
<b>FPTAN</b> = Partial Tangent of ST(0)	ESCAPE 0 0 1	1 1 1 1 0 0 1 0	30-540	
<b>FPATAN</b> = Partial Arctangent of ST(0) - ST(1)	ESCAPE 0 0 1	1 1 1 1 0 0 1 1	250-800	
<b>F2XM1</b> = $2^{ST(0)} - 1$	ESCAPE 0 0 1	1 1 1 1 0 0 0 0	310-630	
<b>FYL2X</b> = ST(1) * Log <sub>2</sub>  ST(0)	ESCAPE 0 0 1	1 1 1 1 0 0 0 1	900-1100	
<b>FYL2XP1</b> = ST(1) * Log <sub>2</sub>  ST(0) + 1	ESCAPE 0 0 1	1 1 1 1 1 0 0 1	700-1000	
<b>Processor Control</b>				
<b>FINIT</b> = Initialize NPX	ESCAPE 0 1 1	1 1 1 0 0 0 1 1	2-8	
<b>FSETPM</b> = Enter Protected Mode	ESCAPE 0 1 1	1 1 1 0 0 1 0 0	2-8	
<b>FSTSW AX</b> = Store Control Word	ESCAPE 1 1 1	1 1 1 0 0 0 0 0	10-16	
<b>FLDCW</b> = Load Control Word	ESCAPE 0 0 1	MOD 1 0 1 R/M	DISP	7-14
<b>FSTCW</b> = Store Control Word	ESCAPE 0 0 1	MOD 1 1 1 R/M	DISP	12-18
<b>FSTSW</b> = Store Status Word	ESCAPE 1 0 1	MOD 1 1 1 R/M	DISP	12-18
<b>FCLEX</b> = Clear Exceptions	ESCAPE 0 1 1	1 1 1 0 0 0 1 0	2-8	
<b>FSTENV</b> = Store Environment	ESCAPE 0 0 1	MOD 1 1 0 R/M	DISP	40-50
<b>FLDENV</b> = Load Environment	ESCAPE 0 0 1	MOD 1 0 0 R/M	DISP	35-45
<b>FSAVE</b> = Save State	ESCAPE 1 0 1	MOD 1 1 0 R/M	DISP	205-215
<b>FRSTOR</b> = Restore State	ESCAPE 1 0 1	MOD 1 0 0 R/M	DISP	205-215
<b>FINCSTP</b> = Increment Stack Pointer	ESCAPE 0 0 1	1 1 1 1 0 1 1 1	6-12	
<b>FDECSTP</b> = Decrement Stack Pointer	ESCAPE 0 0 1	1 1 1 1 0 1 1 0	6-12	

271029-10

**Table 6. M80287 Extensions to the M80286 Instruction Set (Continued)**

		Clock Count Range
<b>FFREE</b> = Free ST(i)	ESCAPE 1 0 1   1 1 0 0 0 ST(i)	9–16
<b>FNOP</b> = No Operation	ESCAPE 0 0 1   1 1 0 1 0 0 0 0	10–16 271029–15

**NOTES:**

- if mod = 00 then DISP = 0\*, disp-low and disp-high are absent  
if mod = 01 then DISP = disp-low sign-extended to 16-bits, disp-high is absent  
if mod = 10 then DISP = disp-high; disp-low  
if mod = 11 then r/m is treated as an ST(i) field
- if r/m = 000 then EA = (BX) + (SI) + DISP  
if r/m = 001 then EA = (BX) + (DI) + DISP  
if r/m = 010 then EA = (BP) + (SI) + DISP  
if r/m = 011 then EA = (BP) + (DI) + DISP  
if r/m = 100 then EA = (SI) + DISP  
if r/m = 101 then EA = (DI) + DISP  
if r/m = 110 then EA = (BP) + DISP  
if r/m = 111 then EA = (BX) + DISP  
\*except if mod = 000 and r/m = 110 then EA = disp-high; disp-low.
- MF = Memory Format  
00—32-bit Real  
01—32-bit Integer  
10—64-bit Real  
11—16-bit Integer
- ST(0) = Current stack top  
ST(i) i<sup>th</sup> register below stack top
- d = Destination  
0—Destination is ST(0)  
1—Destination is ST(i)
- P = Pop  
0—No pop  
1—Pop ST(0)
- R = Reverse: When d = 1 reverse the sense of R  
0—Destination (op) Source  
1—Source (op) Destination
- For **FSQRT**:  $-0 \leq ST(0) \leq +\infty$   
For **FSCALE**:  $-2^{15} \leq ST(1) < +2^{15}$  and ST(1) integer  
For **F2XM1**:  $0 \leq ST(0) \leq 2^{-1}$   
For **FYL2X**:  $0 < ST(0) < \infty$   
 $-\infty < ST(1) < +\infty$   
For **FYL2XP1**:  $0 \leq |ST(0)| < (2 - \sqrt{2})/2$   
 $-\infty < ST(1) < \infty$   
For **FPTAN**:  $0 \leq ST(0) \leq \pi/4$   
For **FPATAN**:  $0 \leq ST(0) < ST(1) < +\infty$
- ESCAPE bit pattern is 11011.



INTEL CORPORATION, 2200 Mission College Blvd., Santa Clara, CA 95052; Tel. (408) 765-8080

INTEL CORPORATION (U.K.) Ltd., Swindon, United Kingdom; Tel. (0793) 696 000

INTEL JAPAN k.k., Ibaraki-ken; Tel. 029747-8511

Military Operation  
Printed in U.S.A./xxxx/1296/2.5K/RP SM