

Am25LS381/Am54LS381/Am74LS381 Am25LS2517

Arithmetic Logic Unit/Function Generator Low-Power Schottky Integrated Circuits

Am25LS381/Am54LS381/Am74LS381
Am25LS2517

DISTINCTIVE CHARACTERISTICS

- Three arithmetic functions
- Three logic functions
- Preset and clear functions
- Carry output (C_{n+4}) and overflow (OVR) outputs on Am25LS2517
- Generate and propagate outputs for full lookahead carry on Am25LS381
- 8mA sink current over the military temperature range on Am25LS
- 50mV Improved V_{OL} on Am25LS compared to Am54LS/74LS
- 440 μ A source current at HIGH output.

GENERAL DESCRIPTION

The Am25LS381 and Am54LS/74LS381 are arithmetic logic units (ALU)/function generators that perform three arithmetic operations and three logic operations on two 4-bit words. The device can also output forced 0000 (clear) or 1111 (preset). These eight operations are selected using three function select inputs S_0 , S_1 and S_2 as shown in the function table. Full carry lookahead is used over the four-bit field within the device. When devices are cascaded, multi-level full carry lookahead is implemented using a '182 carry lookahead generator and the \bar{G} and \bar{P} outputs on the Am25LS381 or Am54LS/74LS381. The device is packaged in a space-saving (0.3-inch row spacing) 20-pin package. If the C_{n+4} carry output function is required, the Am25LS2517 should be used.

The Am25LS381 is a high-performance version of the Am54LS/74LS381. Improvements include faster A.C. spec-

ifications, higher noise margin and twice the fan-out over the military temperature range.

The Am25LS2517 is an arithmetic logic unit (ALU)/function generator that performs three arithmetic operations and three logic operations on two 4-bit words. The device can also force output 0000 (clear) or 1111 (preset). These eight operations are selected using three function select inputs S_0 , S_1 and S_2 as shown in the function table. Full carry lookahead is used over the four-bit field within the device. When devices are cascaded, the carry output (C_{n+4}) is connected to the carry input (C_n) of the next device. The Am25LS2517 can also detect two's complement overflow. The overflow output (OVR) is defined logically as $C_n + 3^{\oplus} C_{n+4}$.

BLOCK DIAGRAM

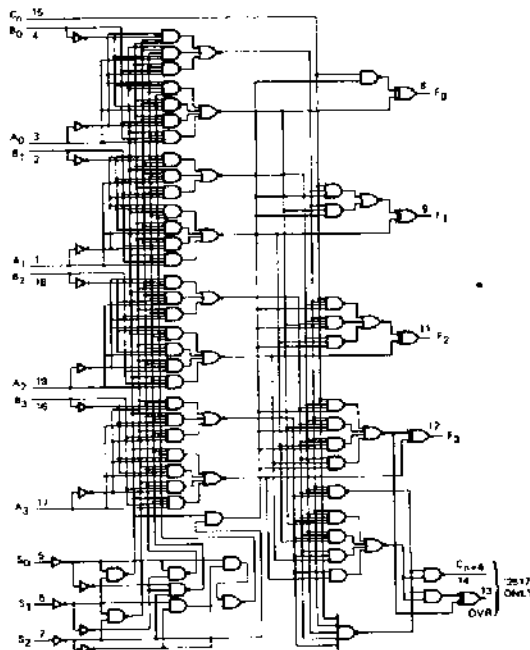

BD001790

9

Am25LS381/Am54LS381/Am74LS381
Am25LS2517

RELATED PRODUCTS

Part No.	Description
Am2901	Bit Slice
Am2903	Bit Slice
Am29203	Super Slice
Am29501	Multiport Pipeline Processor

CONNECTION DIAGRAM Top View

Am25LS2517

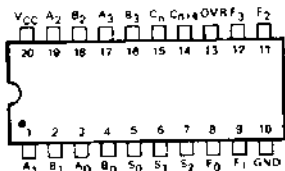

CD004040

Am25LS381
Am54LS/74LS381

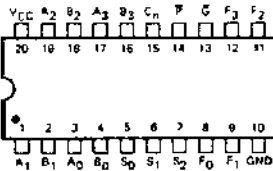

CD004030

Leadless Chip Carriers
L-20-1

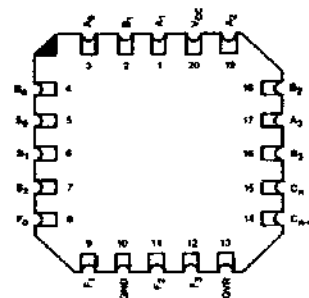

CD004020

Note: Pin 1 is marked for orientation

METALLIZATION AND PAD LAYOUT

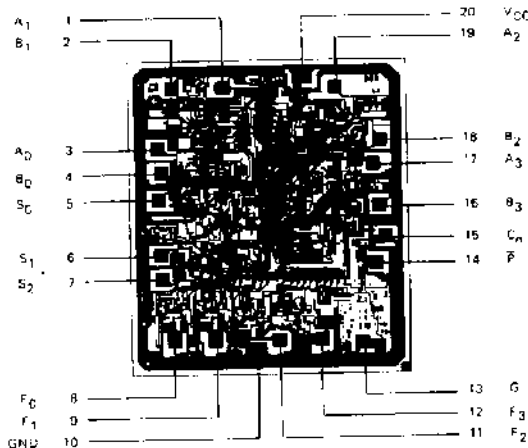

DIE SIZE 0.091" x 0.108"

ORDERING INFORMATION

AMD products are available in several packages and operating ranges. The order number is formed by a combination of the following: Device number, speed option (if applicable), package type, operating range and screening option (if desired).

Am25LS381
Am25LS2517

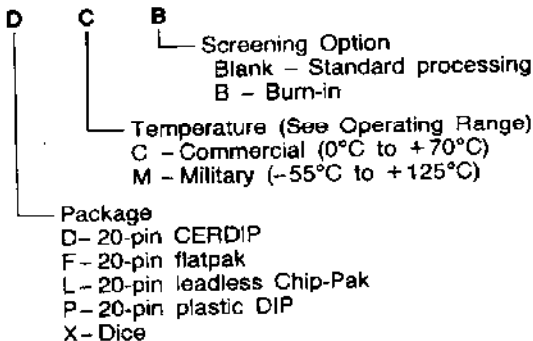

Device type
ALU Function Generators

Valid Combinations	
Am25LS381	PC, PCB DC, DCB, DM, DMB FM, FMB XC, XM
Am25LS2517	PC, PCB DC, DCB, DM, DMB FM, FMB LC, LM, LMB XC, XM

Valid Combinations
Consult the AMD sales office in your area to determine if a device is currently available in the combination you wish.

PIN DESCRIPTION

Pin No.	Name	I/O	Description
3, 1, 19, 17	A ₀ , A ₁ , A ₂ , A ₃	I	The A data inputs.
4, 2, 18, 16	B ₀ , B ₁ , B ₂ , B ₃	I	The B data inputs.
	S ₀ , S ₁ , S ₂ , S ₃	I	The control inputs used to determine the arithmetic or logic function performed.
	F ₀ , F ₁ , F ₂ , F ₃	O	The data outputs of the ALU.
16	C _n	I	The carry-in input of the ALU.
	C _{n+4}	O	The carry-lookahead output of the four-bit input field.
13	\bar{G}	O	The carry-generate output for use in multi-level lookahead schemes.
14	\bar{P}	O	The carry-propagate output for use in multi-level lookahead schemes.
13	OVR		Overflow. This pin is logically the Exclusive-OR of the carry-in and carry-out of the MSB of the ALU. At the most significant end of the word, this pin indicates that the result of an arithmetic two's complement operation has overflowed into the sign-bit.

FUNCTION TABLE

Selection			Arithmetic/Logic Operation
S ₂	S ₁	S ₀	
L	L	L	Clear
L	L	H	B Minus A
L	H	L	A Minus B
L	H	H	A Plus B
H	L	L	A⊗B
H	L	H	A + B
H	H	L	AB
H	H	H	Preset

H = High Level, L = Low Level

See Truth Table for full description.

GUARANTEED LOADING RULES OVER OPERATING RANGE (In Unit Loads)

A Low-Power Schottky TTL Unit Load is defined as 20μA measured at 2.7V HIGH and -0.36mA measured at 0.4V LOW.

Pin Nos.	Input/Output	Am25LS				Am54LS/74LS			
		Input Load	Output HIGH	Output LOW		Input Load	Output HIGH	Output LOW	
			-440μA	MIL	COM'L		-440μA	MIL	COM'L
1	A ₁	4.0	-	-	-	4.4	-	-	-
2	B ₁	4.0	-	-	-	4.4	-	-	-
3	A ₀	4.0	-	-	-	4.4	-	-	-
4	B ₀	4.0	-	-	-	4.4	-	-	-
5	S ₀	1.0	-	-	-	1.1	-	-	-
6	S ₁	1.0	-	-	-	1.1	-	-	-
7	S ₂	1.0	-	-	-	1.1	-	-	-
8	F ₀	-	22	22	22	-	20	11	22
9	F ₁	-	22	22	22	-	20	11	22
10	GND	-	-	-	-	-	-	-	-
11	F ₂	-	22	22	22	-	20	11	22
12	F ₃	-	22	22	22	-	20	11	22
13	\bar{G} or OVR*	-	22	44	44	-	20	44	44
14	\bar{P} or C _{n+4}	-	22	22	22	-	20	11	22
15	C _n	3.0**	-	-	-	4.4	-	-	-
16	B ₃	4.0	-	-	-	4.4	-	-	-
17	A ₃	4.0	-	-	-	4.4	-	-	-
18	B ₂	4.0	-	-	-	4.4	-	-	-
19	A ₂	4.0	-	-	-	4.4	-	-	-
20	V _{CC}	-	-	-	-	-	-	-	-

*OVR Drive is 22 Unit Loads.

**4.0 for Am25LS2517.

Am25LS/54LS/74LS381 TEST TABLE

Path		Same Bit				Other Data Bits		Output Waveform		
In	Out	S ₀	S ₁	S ₂	C _n	4.5V	GND		4.5V	GND
C _n	Any F	1	0	0	-	-	-	All A's & B's	-	out-of-phase
C _n	F _i	1	0	0	-	B _i	A _i	All A's & B's	-	in-phase
A _i	\bar{G}	1	1	0	X	B _i	-	All B's	All A's	out-of-phase
B _i	\bar{G}	1	1	0	X	A _i	-	All B's	All A's	out-of-phase
A _i	\bar{P}	X	X	1	X	B _i	-	All A's & B's	-	out-of-phase
B _i	\bar{P}	1	1	0	X	-	A _i	All B's	All A's	out-of-phase
A _i	F _i	0	1	0	0	-	B _i	-	A's & B's	out-of-phase
A _i	F _i	0	1	0	1	-	B _i	-	A's & B's	in-phase
B _i	F _i	0	1	0	0	-	A _i	-	A's & B's	out-of-phase
B _i	F _i	0	1	0	1	-	A _i	-	A's & B's	in-phase
A _i	F _{i+1}	0	1	0	1	B _i	-	A's & B's	-	out-of-phase
B _i	F _{i+1}	1	0	0	1	A _i	-	A's & B's	-	out-of-phase
S ₀	F _i	-	0	0	1	B _i	A _i	All B's	All A's	in-phase
S ₀	\bar{G}	-	1	0	X	-	-	A's & B's	-	out-of-phase
S ₀	\bar{P}	-	1	0	X	-	-	All B's	All A's	out-of-phase
S ₁	F _i	0	-	0	1	A _i	B _i	All A's	All B's	in-phase
S ₁	\bar{G}	1	-	0	X	-	-	A's & B's	-	out-of-phase
S ₁	\bar{P}	1	-	0	X	-	-	All A's	All B's	out-of-phase
S ₂	\bar{G}	0	1	-	1	A _i	B _i	All A's	All B's	out-of-phase
S ₂	\bar{P}	1	1	-	X	-	-	A's & B's	-	in-phase
S ₂	\bar{P}	1	1	-	X	-	-	All A's	All B's	in-phase

X = Don't care

Am25LS381/Am54LS381/Am74LS381
Am25LS2517

9

Am25LS/54LS/74LS381
TRUTH TABLE

FUNCTION	INPUTS						OUTPUTS							
	S ₀	S ₁	S ₂	C _n	A _n	B _n	F ₀	F ₁	F ₂	F ₃	\bar{G}	\bar{P}		
CLEAR	0	0	0	X	X	X	0	0	0	0	0	0		
B MINUS A	1	0	0	0	0	0	1	1	1	1	1	0		
				0	0	1	0	1	1	1	0	0	0	
				0	1	0	0	0	0	0	0	1	1	1
				0	1	1	1	1	1	1	1	1	1	0
				1	0	0	0	0	0	0	0	0	1	0
				1	0	1	1	1	1	1	1	1	0	0
				1	1	0	1	0	0	1	0	0	0	1
A MINUS B	0	1	0	0	0	0	1	1	1	1	1	0		
				0	0	1	0	0	0	0	1	1	1	
				0	1	0	0	1	1	1	1	0	0	0
				0	1	1	1	1	1	1	1	1	1	0
				1	0	0	0	0	0	0	0	1	0	1
				1	0	1	1	0	0	1	0	0	1	1
				1	1	0	1	1	1	1	1	1	0	0
A PLUS B	1	1	0	0	0	0	0	0	0	0	1	1		
				0	0	1	1	1	1	1	1	1	0	
				0	1	0	1	1	1	1	1	1	0	0
				0	1	1	0	1	1	1	1	0	1	1
				1	0	0	1	0	0	0	0	1	0	1
				1	0	1	0	0	0	0	0	1	0	0
				1	1	0	1	1	1	1	1	0	0	0
A ⊕ B	0	0	1	X	0	0	0	0	0	0	1	1		
				X	0	1	1	1	1	1	1	1		
				X	1	0	1	1	1	1	1	0		
				X	1	1	0	0	0	0	0	0		
A + B	1	0	1	X	0	0	0	0	0	1	1			
				X	0	1	1	1	1	1	1			
				X	1	0	1	1	1	1	1			
				X	1	1	1	1	1	1	0			
AB	0	1	1	X	0	0	0	0	0	0	0			
				X	0	1	0	0	0	0	1	1		
				X	1	0	0	0	0	0	0			
				X	1	1	1	1	1	1	1			
PRESET	1	1	1	X	0	0	1	1	1	1	1			
				X	0	1	1	1	1	1	1			
				X	1	0	1	1	1	1	1			
				X	1	1	1	1	1	1	0			

**Am25LS2517
TEST TABLE**

Path		S ₀	S ₁	S ₂	C _n	Same Bit		Other Data Bits		Output Waveform
In	Out					4.5V	GND	4.5V	GND	
C _n	Any F	1	0	0	-	-	-	A's & B's	None	out-of-phase
C _n	F _i	1	0	0	-	B _i	A _i	A's & B's	None	in-phase
A _i	F _i	0	1	0	0	-	B _i	None	A's & B's	out-of-phase
A _i	F _i	0	1	0	1	-	B _i	None	A's & B's	in-phase
A _i	OVRF	0	1	1	1	B _i	-	A's & B's	None	in-phase
A _i	C _{n+4}	0	1	1	1	B _i	-	A's & B's	None	in-phase
B _i	F _i	0	1	0	0	-	A _i	None	A's & B's	out-of-phase
B _i	F _i	0	1	0	1	-	A _i	-	A's & B's	in-phase
B _i	OVRF	0	1	1	0	A _i	-	A's & B's	None	out-of-phase
B _i	C _{n+4}	0	1	1	0	A _i	-	A's & B's	None	out-of-phase
A _i	F _{i+1}	0	1	0	1	B _i	-	A's & B's	None	out-of-phase
B _i	F _{i+1}	1	0	0	1	A _i	-	A's & B's	None	out-of-phase
S ₀	F _i	-	0	0	1	B _i	A _i	All B's	All A's	in-phase
S ₀	OVRF	-	1	1	0	-	-	None	A's & B's	out-of-phase
S ₀	C _{n+4}	-	1	1	0	-	-	None	A's & B's	out-of-phase
S ₁	F _i	0	-	0	1	A _i	B _i	All A's	All B's	in-phase
S ₁	OVRF	0	-	1	X	-	-	None	A's & B's	in-phase
S ₁	C _{n+4}	0	-	1	X	-	-	None	A's & B's	in-phase
S ₂	F _i	0	1	-	1	A _i	B _i	All A's	All B's	in-phase
S ₂	OVRF	0	1	-	0	-	-	None	A's & B's	out-of-phase
S ₂	C _{n+4}	0	1	-	0	-	-	None	A's & B's	in-phase

Am25LS2517
TRUTH TABLE

FUNCTION	INPUTS						OUTPUTS					
	S ₀	S ₁	S ₂	C _n	A _n	B _n	F ₀	F ₁	F ₂	F ₃	\bar{G}	P
CLEAR	0	0	0	0	X	X	0	0	0	0	1	1
				1	X	X	0	0	0	0	1	1
B MINUS A				0	0	0	1	1	1	1	0	0
				0	0	1	0	1	1	1	0	1
				0	1	0	0	0	0	0	0	0
	1	0	0	0	1	1	1	1	1	1	0	0
				1	0	0	0	0	0	0	0	1
				1	0	1	1	1	1	1	0	1
				1	1	0	1	0	0	0	0	0
				1	1	1	0	0	0	0	0	1
A MINUS B				0	0	0	1	1	1	1	0	0
				0	0	1	0	0	0	0	0	0
				0	1	0	0	1	1	1	0	1
	0	1	0	0	1	1	1	1	1	1	0	0
				1	0	0	0	0	0	0	0	1
				1	0	1	1	0	0	0	0	0
				1	1	0	1	1	1	1	0	1
				1	1	1	0	0	0	0	0	1
A PLUS B				0	0	0	0	0	0	0	0	0
				0	0	1	1	1	1	1	0	0
				0	1	0	1	1	1	1	0	0
	1	1	0	0	1	1	0	1	1	1	0	1
				1	0	0	1	0	0	0	0	0
				1	0	1	0	0	0	0	0	1
				1	1	0	0	0	0	0	0	1
				1	1	1	1	1	1	1	0	1
A ⊕ B				0	0	0	0	0	0	0	1	1
				0	0	1	1	1	1	1	0	0
				0	1	0	1	1	1	1	0	0
	0	0	1	0	1	1	0	0	0	0	1	1
				1	0	0	0	0	0	0	0	0
				1	0	1	1	1	1	1	0	0
				1	1	0	1	1	1	1	1	1
				1	1	1	0	0	0	0	1	1
A + B				0	0	0	0	0	0	0	1	1
				0	0	1	1	1	1	1	0	0
				0	1	0	1	1	1	1	0	0
	1	0	1	0	1	1	1	1	1	1	0	0
				1	0	0	0	0	0	0	0	0
				1	0	1	1	1	1	1	0	0
				1	1	0	1	1	1	1	0	0
				1	1	1	1	1	1	1	1	1
AB				0	0	0	0	0	0	0	1	1
				0	0	1	0	0	0	0	0	0
				0	1	0	0	0	0	0	1	1
	0	1	1	0	1	1	1	1	1	1	0	0
				1	0	0	0	0	0	0	1	1
				1	0	1	0	0	0	0	0	0
				1	1	0	0	0	0	0	1	1
				1	1	1	1	1	1	1	1	1
PRESET				0	0	0	1	1	1	1	0	0
				0	0	1	1	1	1	1	0	0
				0	1	0	1	1	1	1	0	0
	1	1	1	0	1	1	1	1	1	1	0	0
				1	0	0	1	1	1	1	0	0
				1	0	1	1	1	1	1	0	0
				1	1	0	1	1	1	1	0	0
				1	1	1	1	1	1	1	1	1

APPLICATIONS

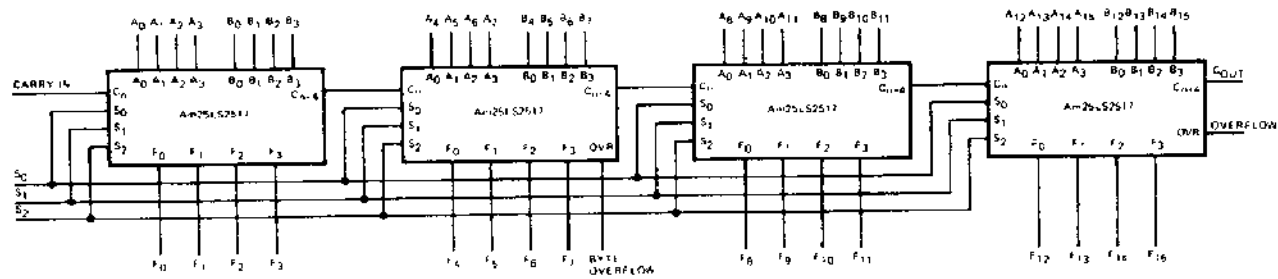

AF001430

TYPICAL SPEED CALCULATIONS

Path	Output	
	F	C _n + 4, OVR
A _i or B _i to C _n + 4	24 ns	24 ns
C _n to C _n + 4	15 ns	15 ns
C _n to C _n + 4	15 ns	15 ns
C _n to F _i	16 ns	-
C _n to C _n + 4, OVR	-	15 ns
16-Bit Speed	70 ns	69 ns

The Am25LS2517 in a 16-Bit Ripple Carry ALU Connection.

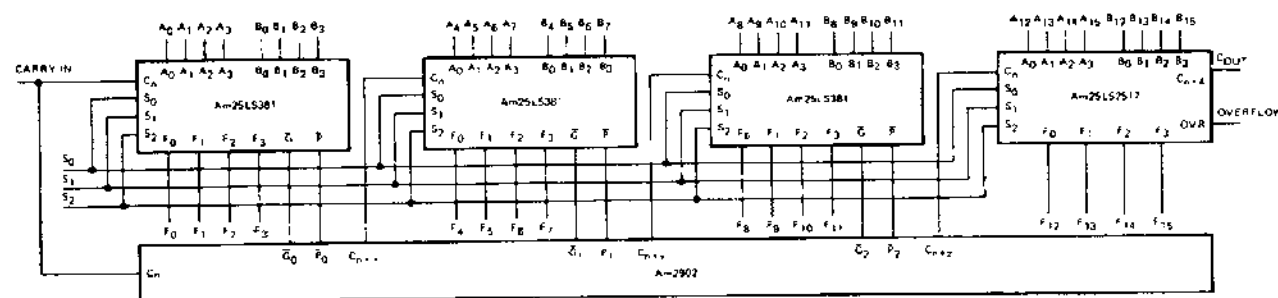

AF001420

TYPICAL SPEED CALCULATIONS

Path	Output	
	F	C _n + 4, OVR
A _i or B _i to \bar{G} or P	20 ns*	20 ns*
\bar{G}_i or P _i to C _{i+j} (Am2802)	8 ns	8 ns
C _n to F	16 ns	-
C _n to C _n + 4, OVR	-	15 ns
16-Bit Speed	44 ns	43 ns

* Note that S_i to G or P may be longer path.

The Am25LS2517 and Am25LS381 in a 16-Bit Carry Lookahead ALU Connection.

USER NOTES

- Throughout this data sheet, the active HIGH input and output terminology has been used.
- Arithmetic operations are performed on a word basis.
- Logic operations are performed on a bit basis.

- Arithmetic in 1's complement notation requires an end around carry.
- Subtraction in 2's complement notation requires a carry in (C_n = HIGH) for the active HIGH case.

ABSOLUTE MAXIMUM RATINGS

Storage Temperature -65°C to +150°C
 (Ambient) Temperature Under Bias -55°C to +125°C
 Supply Voltage to Ground Potential
 Continuous -0.5V to +7.0V
 DC Voltage Applied to Outputs For
 High Output State -0.5V to +V_{CC} max
 DC Input Voltage (Except Am25LS2517,
 C_N input = 5.5V) -0.5V to +7.0V
 DC Output Current, Into Outputs 30mA
 DC Input Current -30mA to +5.0mA

Stresses above those listed under ABSOLUTE MAXIMUM RATINGS may cause permanent device failure. Functionality at or above these limits is not implied. Exposure to absolute maximum ratings for extended periods may affect device reliability.

OPERATING RANGES

Commercial (C) Devices
 Temperature 0°C to +70°C
 Supply Voltage +4.75V to +5.25V
 Military (M) Devices
 Temperature -55°C to +125°C
 Supply Voltage +4.5V to +5.5V
Operating ranges define those limits over which the functionality of the device is guaranteed.

DC CHARACTERISTICS over operating range unless otherwise specified Am25LS381 • Am25LS2517

Parameters	Description	Test Conditions (Note 2)		Min	Typ (Note 1)	Max	Units	
V _{OH}	Output HIGH Voltage	V _{CC} = MIN, I _{OH} = -440µA V _{IN} = V _{IH} or V _{IL}	MIL	2.5	3.4		Volts	
			COM'L	2.7	3.4			
V _{OL}	Output LOW Voltage	V _{CC} = MIN V _{IN} = V _{IH} or V _{IL}	I _{OL} = 4.0 mA			0.4	Volts	
			I _{OL} = 8.0mA			0.45		
			\bar{G} , I _{OL} = 16mA			0.55		
V _{IH}	Input HIGH Level	Guaranteed input logical HIGH voltage for all inputs		2.0			Volts	
V _{IL}	Input LOW Level	Guaranteed input logical LOW voltage for all inputs.	MIL			0.7	Volts	
			COM'L			0.8		
V _I	Input Clamp Voltage	V _{CC} = MIN, I _I = -18mA				-1.5	Volts	
I _{IL}	Input LOW Current	V _{CC} = MAX, V _{IN} = 0.4V	Any S			-0.36	mA	
			Any A or B			-1.44		
			'LS381, C _n			-1.08		
			'LS2517, C _n			-1.44		
I _{IH}	Input HIGH Current	V _{CC} = MAX, V _{IN} = 2.7V	Any S			20	µA	
			Any A or B			80		
			'LS381, C _n			60		
			'LS2517, C _n			80		
I _I	Input HIGH Current	V _{CC} = MAX, V _{IN} = 7.0V	Any S			0.1	mA	
			Any A or B			0.4		
			'LS381, C _n			0.3		
		V _{CC} = MAX, V _{IN} = 5.5V	'LS2517, C _n			0.4		
I _{SC}	Output Short Circuit Current (Note 3)	V _{CC} = MAX		-15		-85	mA	
I _{CC}	Power Supply Current (Note 4)	V _{CC} = MAX	MIL	Am25LS381			40	mA
				Am25LS2517			43	
			COM'L	Am25LS381		25	43	
				Am25LS2517		27	47	

- Notes: 1. Typical limits are at V_{CC} = 5.0V, 25°C ambient and maximum loading.
 2. For conditions shown as MIN or MAX, use the appropriate value specified under Operating Ranges for the applicable device type.
 3. Not more than one output should be shorted at a time. Duration of the short circuit test should not exceed one second.
 4. Test conditions: LS381: S₀ = S₁ = S₂ = GND, all other inputs open.
 LS2517: S₀ = C_n = open, all other inputs = GND.

DC CHARACTERISTICS over operating range unless otherwise specified
AM54LS/74LS381

Parameters	Description	Test Conditions (Note 2)		Min	Typ (Note 1)	Max	Units
VOH	Output HIGH Voltage	VCC = MIN, IOH = -400µA VIN = VIH or VIL		MIL	2.5	3.4	Volts
				COM'L	2.7	3.4	
VOL	Output LOW Voltage	VCC = MIN VIN = VIH or VIL		IOL = 4.0 mA		0.4	Volts
				74LS only, IOL = 8mA		0.5	
				P, IOL = 8.0mA		0.5	
				G, IOL = 16mA		0.65	
VIH	Input HIGH Level	Guaranteed input logical HIGH voltage for all inputs		2.0			Volts
VIL	Input LOW Level	Guaranteed input logical LOW voltage for all inputs.		MIL		0.7	Volts
				COM'L		0.8	
VI	Input Clamp Voltage	VCC = MIN, IIN = -18mA				-1.5	Volts
IIL	Input LOW Current (Note 5)	VCC = MAX, VIN = 0.4V		Any S		-0.4	mA
				Others		-1.6	
IIH	Input HIGH Current (Note 5)	VCC = MAX, VIN = 2.7V		Any S		20	µA
				Others		80	
II	Input HIGH Current (Note 5)	VCC = MAX, VIN = 7.0V		Any S		0.1	mA
				Others		0.4	
ISC	Output Short Circuit Current (Note 3)	VCC = MAX		-15		-100	mA
ICC	Power Supply Current (Note 4)	VCC = MAX			25	43	mA

- Notes: 1. Typical limits are at VCC = 5.0V, 25°C ambient and maximum loading.
 2. For conditions shown as MIN or MAX, use the appropriate value specified under Operating Ranges for the applicable device type.
 3. Not more than one output should be shorted at a time. Duration of the short circuit test should not exceed one second.
 4. Test conditions: LS381: S0 = S1 = S2 = GND, all other inputs open.
 LS2517: S0 = Cn = open, all other inputs = GND.
 5. Limits chosen by AMD based on SN545/74S381, T, I, LS data unavailable.

SWITCHING CHARACTERISTICS (TA = +25°C, VCC = 5.0V)

Parameters	Description	Test Conditions	Am25LS			Am54LS/74LS			Units
			Min	Typ	Max	Min	Typ	Max	
tPLH	Cn to Fi	CL = 15pF RL = 2.0kΩ		14	21			26	ns
tPHL				16	24			30	
tPLH	Ai to Bi to Fi			16	24			30	ns
tPHL				23	35			40	
tPLH	Si to Fi			20	30			35	ns
tPHL				25	37			40	
tPLH	Ai or Bi to G (LS381 Only)			20	30			35	ns
tPHL				15	23			30	
tPLH	Ai or Bi to P (LS381 Only)			17	26			34	ns
tPHL				15	23			30	
tPLH	Si to G or P (LS381 Only)			32	48			55	ns
tPHL				23	35			42	
tPLH	Ai or Bi to OVR (LS2517 Only)			23	34			-	ns
tPHL				24	36			-	
tPLH	Ai or Bi to Cn+4 (LS2517 Only)			21	32			-	ns
tPHL				24	36			-	
tPLH	Si to OVR or Cn+4 (LS2517 Only)			27	41			-	ns
tPHL				37	55			-	
tPLH	Cn to Cn+4 (LS2517 Only)			14	21			-	ns
tPHL				15	22			-	
tPLH	Cn to OVR (LS2517 Only)		15	22			-	ns	
tPHL			15	22			-		

Am25LS only

SWITCHING CHARACTERISTICS over operating range unless otherwise specified*

Parameters	Description	Test Conditions	COMMERCIAL		MILITARY		Units
			Am25LS		Am25LS		
			Min	Max	Min	Max	
t _{PLH}	C _n to F _i	C _L = 50pF R _L = 2.0KΩ		27		30	ns
t _{PHL}				35		42	
t _{PLH}	A _i or B _i to F _i			32		36	ns
t _{PHL}				44		50	
t _{PLH}	S _i to F _i			38		42	ns
t _{PHL}				48		55	
t _{PLH}	A _i or B _i to \bar{G} ('LS381 Only)			37		40	ns
t _{PHL}				31		36	
t _{PLH}	A _i or B _i to \bar{P} ('LS381 Only)			34		39	ns
t _{PHL}				34		42	
t _{PLH}	S _i to \bar{G} or \bar{P} ('LS381 Only)			57		63	ns
t _{PHL}				47		55	
t _{PLH}	A _i or B _i to OVR ('LS2517 Only)			41		45	ns
t _{PHL}				47		55	
t _{PLH}	A _i or B _i to C _{n+4} ('LS2517 Only)			38		40	ns
t _{PHL}				46		52	
t _{PLH}	S _i to OVR or C _{n+4} ('LS2517 Only)		52		60	ns	
t _{PHL}			66		75		
t _{PLH}	C _n to C _{n+4} ('LS2517 Only)		28		32	ns	
t _{PHL}			28		30		
t _{PLH}	C _n to OVR ('LS2517 Only)		30		35	ns	
t _{PHL}			28		30		

*AC performance over the operating temperature range is guaranteed by testing defined in Group A, Subgroup B.

**Am25LS/Am54LS/74LS
LOW-POWER SCHOTTKY INPUT/OUTPUT
CURRENT INTERFACE CONDITIONS**

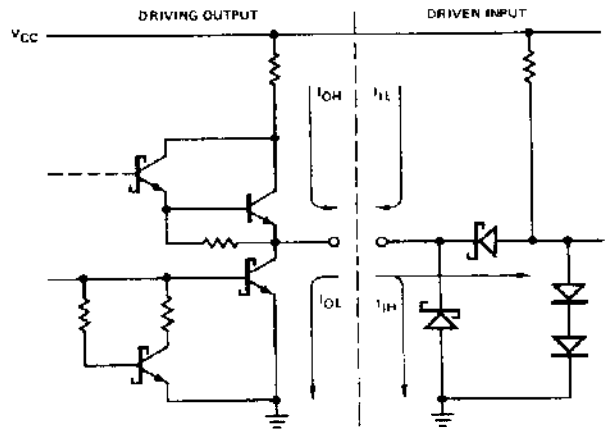

Note: Actual current flow direction shown.