

PRODUCT NUMBER  
SEE TABLE

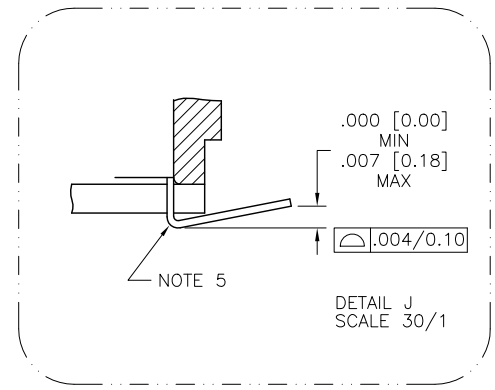
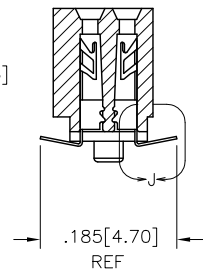
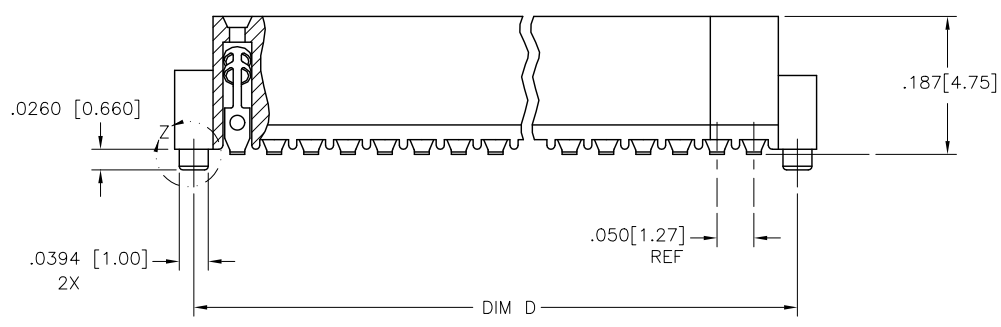
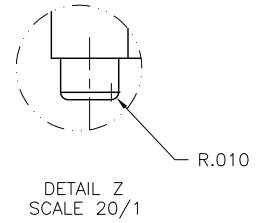
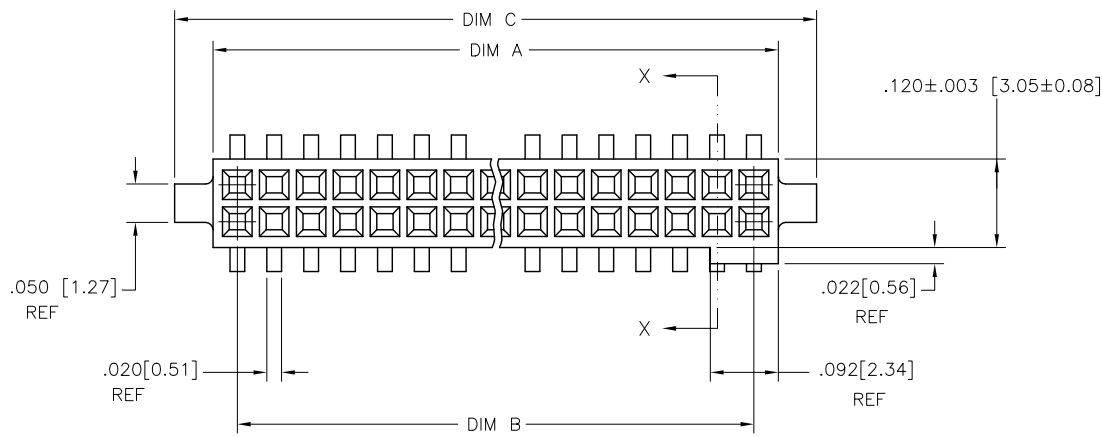

mat'l. code				surface		tolerance		projection		product family	
-				ISO 1302 ✓		ISO 406 ISO 1101				RIB CAGE	
ltr	ecn no	dr	date	tolerances unless otherwise specified						title	
J	V11874	CRG	7/26/01	angles	linear	xx ±.01/.3		INCH/MM		.050/1.27cc V.C.C. SMT	
K	M05-0123	MHT	6/07/05			xxx ±.005/.13				w/LOC. & POL. FEATURES	
L	M06-0284	AEA	7/27/06	σ±2'		xxxx ±.0020/.050		scale 4:1		dwg no	
M	M09-0058	MHT	4/04/09	dr	D. SHEAFER	02/01/93				sheet 1 of 3 size	
N	N10-0174	YO	6/17/10	engr	J. SHUEY	02/01/93				93188 A3	
P	N11-0186	YO	6/09/11	chr	J. SHUEY	02/01/93				type Product Customer Drawing	
R	ELX-N-010209	YO	2/8/12	appd	J. SHUEY	02/01/93					
sheet	revision	R	R	R							
index	sheet	1	2	3							

PRODUCT NO. NOTE 8	SIZE	DIM A	DIM B	DIM C	DIM D	SPECIAL PACKAGING	TAPE WIDTH/PITCH	PIECES PER REEL
93188-610	2 X 10	.516/13.11	.450/11.43	.620/15.75	.570/14.48	NOTE 6	24mm/12mm	750
-615	2 X 15	.766/19.46	.700/17.78	.870/22.10	.820/20.83	NOTE 6	44mm/12mm	500
-620	2 X 20	1.016/25.806	.950/24.13	1.120/28.448	1.0700/27.178	-----	-----	-----
-625	2 X 25	1.266/32.156	1.200/30.48	1.370/34.798	1.3200/33.528	-----	-----	-----
-630	2 X 30	1.516/38.506	1.450/36.83	1.620/41.148	1.5700/39.878	-----	-----	-----
-635	2 X 35	1.766/44.856	1.700/43.18	1.870/47.498	1.8200/46.228	-----	-----	-----
-640	2 X 40	2.016/51.206	1.950/49.53	2.120/53.848	2.0700/52.578	-----	-----	-----
-645	2 X 45	2.266/57.556	2.200/55.88	2.370/60.198	2.3200/58.928	-----	-----	-----
93188-650	2 X 50	2.516/63.906	2.450/62.23	2.620/66.548	2.5700/65.278	-----	-----	-----

NOTES

- HOUSING MATERIAL :  
GLASS FILLED THERMOPLASTIC FLAME RETARDANT PER UL 94V-0  
COLOR : NATURAL
- TERMINAL MATERIAL : BeCu
- TERMINAL PLATING :  
30u"/.76u MIN HARD GOLD OR GXT OVER Ni ON CONTACT ZONES.  
100u"/2.54u MIN TIN OVER Ni IN SOLDERING ZONES.  
OTHERWISE GOLD FLASH OR UNPLATED.
- APPLICATION INFORMATION :  
A. RECOMMENDED MOUNTING PAD PATTERN IS SHOWN IN FIGURE "A".  
B. MATING PINS TO BE .0176/0.447 TO .0181/0.459 DIA.  
C. MATING PIN TIPS TO BE IN TRUE POSITION TO MATING GRID WITHIN .008/0.20 DIA.  
D. SUGGESTED MATING PIN LENGTH .130/3.30 ±.010/0.25.
- LEAD TIPS TO BE ABOVE HEEL, UP TO .007/0.18 MAX.  
COPLANARITY TO BE MEASURED AT LOWEST POINT (HEEL).
- ADD "TR" TO END OF DASH NUMBER FOR TAPE AND REEL PACKAGE WITH CAP. TOOLED ONLY FOR NOTED CONNECTORS.
- ADD "CT" TO END OF DASH NUMBER FOR CONNECTOR WITH VACUUM CAP IN TUBE.
- ADD "LF" SUFFIX AT THE END OF PART NUMBER FOR LEAD FREE OPTION.
- IF LF P/N THE PRODUCT MEETS EUROPEAN UNION DIRECTIVES AND OTHER COUNTRY REGULATION AS DESCRIBED IN GS-22-008.
- THE HOUSING WILL WITHSTAND EXPOSURE TO 260°C PEAK TEMPERATURE FOR 20 SECONDS IN A CONVECTION, INFRA-RED OR VAPOR PHASE REFLOW OVEN. SEE APPLICATION NOTES/PROCEDURES IF THEY ARE AVAILABLE.
- PRODUCT SPECIFICATION PER BUS-12-087.

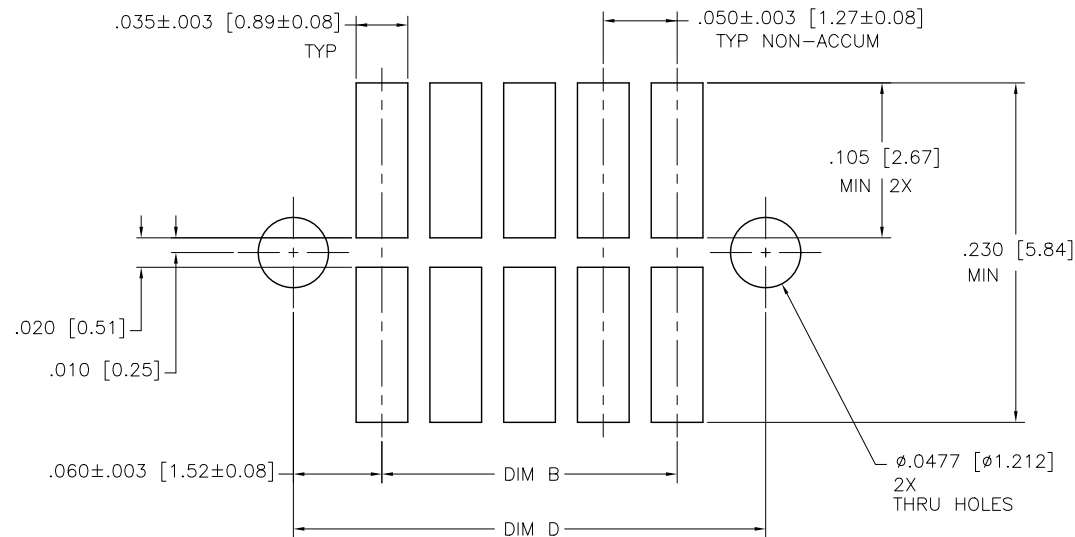

FIGURE A  
RECOMMENDED  
P.C.B. LAYOUT

mat'l. code		surface		tolerance		projection		product family	
-		ISO 1302 ✓		ISO 406 ISO 1101				RIB CAGE	
ltr		ecn		no		dr		date	
R									
				tolerances unless otherwise specified				title	
				angles		linear		.050/1.27cc V.C.C. SMT	
				σ±2'		xxx ±.005/.13		w/LOC. & POL. FEATURES	
				dr		D. SHEAFER 02/01/93		dwg no	
				enrg		J. SHUEY 02/01/93		sheet 2 of 3	
				chr		J. SHUEY 02/01/93		size	
				appd		J. SHUEY 02/01/93		A3	
sheet		revision						type	
index		sheet						Product Customer Drawing	

1 2 3 4 5 6

REFERENCE ONLY

UNREELING  
DIRECTION

TAPE WIDTH'S 32mm AND ABOVE HAS BOTH FEED TRACKS,  
BELOW 32mm HAS TOP FEED TRACK ONLY.

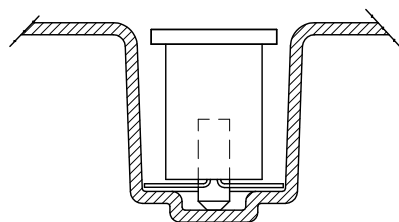
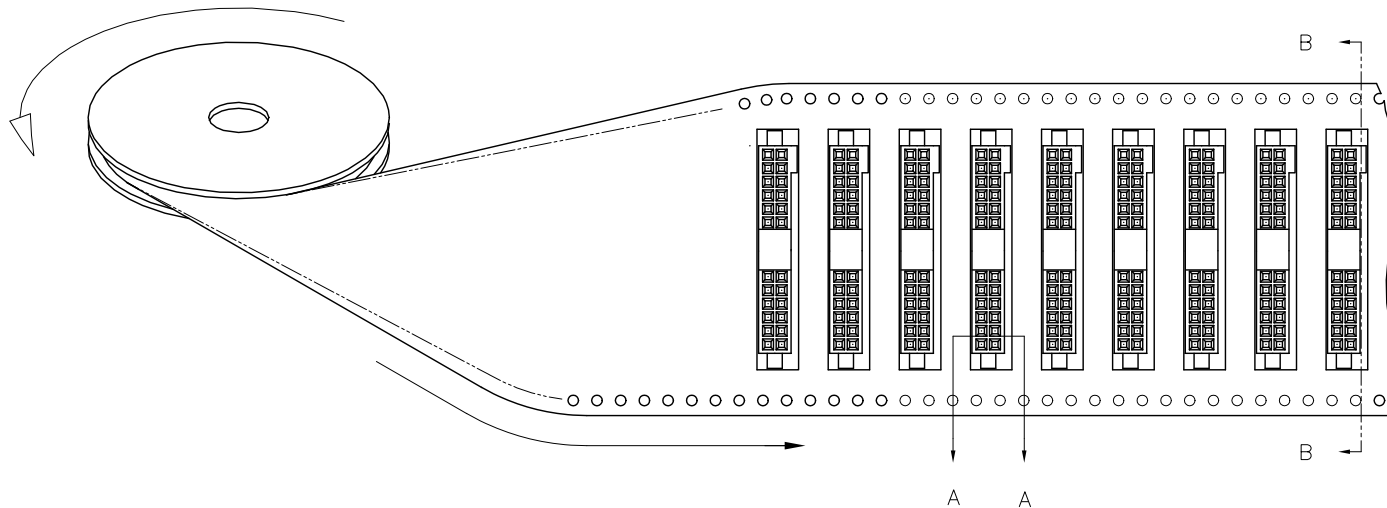

SECTION A-A

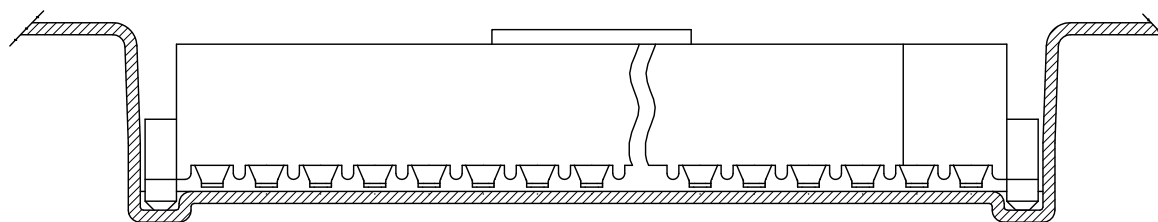

SECTION B-B

mat'l. code		surface		tolerance		projection		product family	
-		ISO 1302 ✓		ISO 406 ISO 1101				RIB CAGE	
ltr	ecn	no	dr	date	tolerances unless otherwise specified			title	
R					angles	linear	$xx \pm .01/.3$ $xxx \pm .005/.13$ $xxxx \pm .0020/.050$	INCH/MM scale 4:1	
					$\sigma \pm 2'$			.050/1.27cc V.C.C. SMT w/LOC. & POL. .FEATURES	
			dr	D. SHEAFER	02/01/93			dwg no sheet 3 of 3 size 93188 A3	
			enr	J. SHUEY	02/01/93				
			chr	J. SHUEY	02/01/93			type Product Customer Drawing	
			appd	J. SHUEY	02/01/93				
sheet	revision								
index	sheet								

FCI  
FCIconnect.com

Copyright FCI