

# DATA SHEET

For a complete data sheet, please also download:

- The IC06 74HC/HCT/HCU/HCMOS Logic Family Specifications
- The IC06 74HC/HCT/HCU/HCMOS Logic Package Information
- The IC06 74HC/HCT/HCU/HCMOS Logic Package Outlines

## 74HC/HCT573

Octal D-type transparent latch;  
3-state

Product specification  
File under Integrated Circuits, IC06

December 1990

## Octal D-type transparent latch; 3-state

## 74HC/HCT573

## FEATURES

- Inputs and outputs on opposite sides of package allowing easy interface with microprocessors
- Useful as input or output port for microprocessors/microcomputers
- 3-state non-inverting outputs for bus oriented applications
- Common 3-state output enable input
- Functionally identical to the "563" and "373"
- Output capability: bus driver
- I<sub>CC</sub> category: MSI

## GENERAL DESCRIPTION

The 74HC/HCT573 are high-speed Si-gate CMOS devices and are pin compatible with low power Schottky TTL (LSTTL). They are specified in compliance with JEDEC standard no. 7A.

The 74HC/HCT573 are octal D-type transparent latches featuring separate D-type inputs for each latch and 3-state outputs for bus oriented applications.

A latch enable ( $\overline{LE}$ ) input and an output enable ( $\overline{OE}$ ) input are common to all latches.

The "573" consists of eight D-type transparent latches with 3-state true outputs. When LE is HIGH, data at

the D<sub>n</sub> inputs enter the latches. In this condition the latches are transparent, i.e. a latch output will change state each time its corresponding D-input changes.

When LE is LOW the latches store the information that was present at the D-inputs a set-up time preceding the HIGH-to-LOW transition of LE.

When  $\overline{OE}$  is LOW, the contents of the 8 latches are available at the outputs. When  $\overline{OE}$  is HIGH, the outputs go to the high impedance OFF-state.

Operation of the  $\overline{OE}$  input does not affect the state of the latches.

The "573" is functionally identical to the "563" and "373", but the "563" has inverted outputs and the "373" has a different pin arrangement.

## QUICK REFERENCE DATA

GND = 0 V; T<sub>amb</sub> = 25 °C; t<sub>r</sub> = t<sub>f</sub> = 6 ns

SYMBOL	PARAMETER	CONDITIONS	TYPICAL		UNIT
			HC	HCT	
t <sub>PHL</sub> / t <sub>PLH</sub>	propagation delay	C <sub>L</sub> = 15 pF; V <sub>CC</sub> = 5 V			
	D <sub>n</sub> to Q <sub>n</sub>		14	17	ns
	LE to Q <sub>n</sub>		15	15	ns
C <sub>I</sub>	input capacitance		3.5	3.5	pF
C <sub>PD</sub>	power dissipation capacitance per latch	notes 1 and 2	26	26	pF

## Notes

1. C<sub>PD</sub> is used to determine the dynamic power dissipation (P<sub>D</sub> in μW):

$$P_D = C_{PD} \times V_{CC}^2 \times f_i + \sum (C_L \times V_{CC}^2 \times f_o) \text{ where:}$$

f<sub>i</sub> = input frequency in MHz; f<sub>o</sub> = output frequency in MHz

∑ (C<sub>L</sub> × V<sub>CC</sub><sup>2</sup> × f<sub>o</sub>) = sum of outputs

C<sub>L</sub> = output load capacitance in pF; V<sub>CC</sub> = supply voltage in V

2. For HC the condition is V<sub>I</sub> = GND to V<sub>CC</sub>; for HCT the condition is V<sub>I</sub> = GND to V<sub>CC</sub> - 1.5 V

## ORDERING INFORMATION

See "74HC/HCT/HCU/HCMOS Logic Package Information".

Octal D-type transparent latch; 3-state

74HC/HCT573

PIN DESCRIPTION

PIN NO.	SYMBOL	NAME AND FUNCTION
2, 3, 4, 5, 6, 7, 8, 9	D <sub>0</sub> to D <sub>7</sub>	data inputs
11	LE	latch enable input (active HIGH)
1	$\overline{OE}$	3-state output enable input (active LOW)
10	GND	ground (0 V)
19, 18, 17, 16, 15, 14, 13, 12	Q <sub>0</sub> to Q <sub>7</sub>	3-state latch outputs
20	V <sub>CC</sub>	positive supply voltage

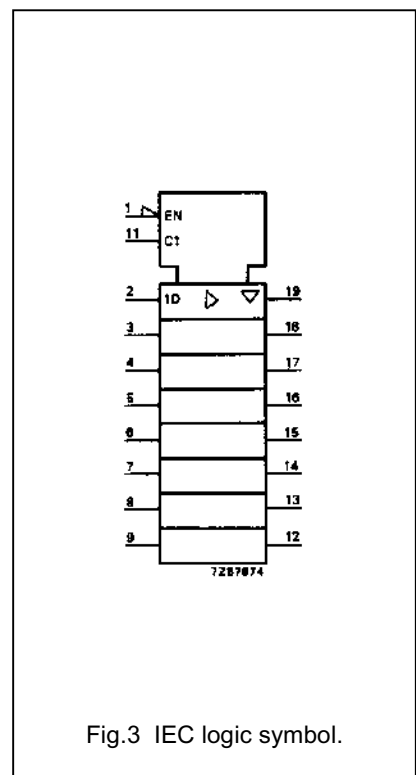
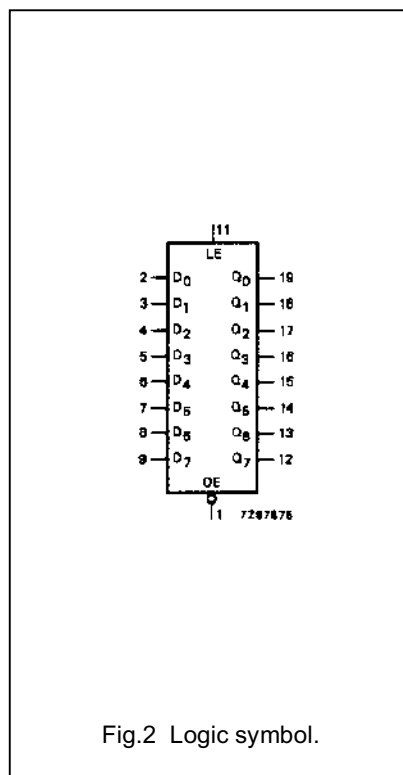
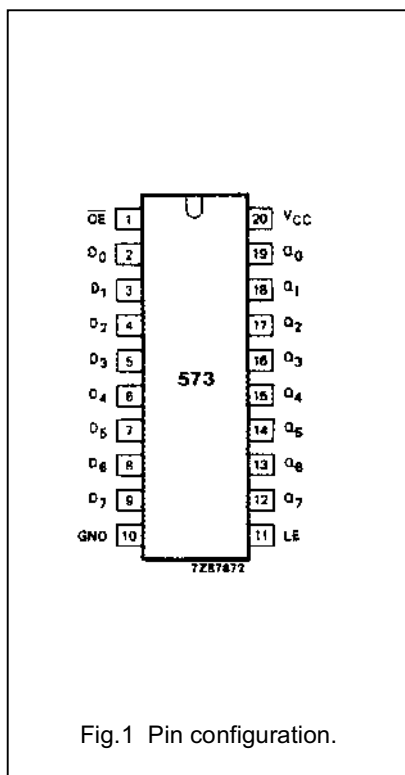

Octal D-type transparent latch; 3-state

74HC/HCT573

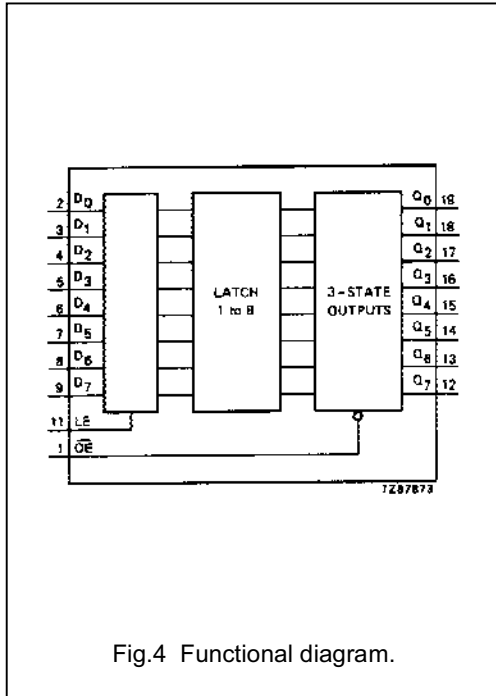

FUNCTION TABLE

OPERATING MODES	INPUTS			INTERNAL LATCHES	OUTPUTS Q <sub>0</sub> to Q <sub>7</sub>
	$\overline{OE}$	LE	D <sub>N</sub>		
enable and read register (transparent mode)	L	H	L	L	L
	L	H	H	H	H
latch and read register	L	L	l	L	L
	L	L	h	H	H
latch register and disable outputs	H	L	l	L	Z
	H	L	h	H	Z

Notes

- H = HIGH voltage level  
 h = HIGH voltage level one set-up time prior to the HIGH-to-LOW LE transition  
 L = LOW voltage level  
 l = LOW voltage level one set-up time prior to the HIGH-to-LOW LE transition  
 Z = high impedance OFF-state

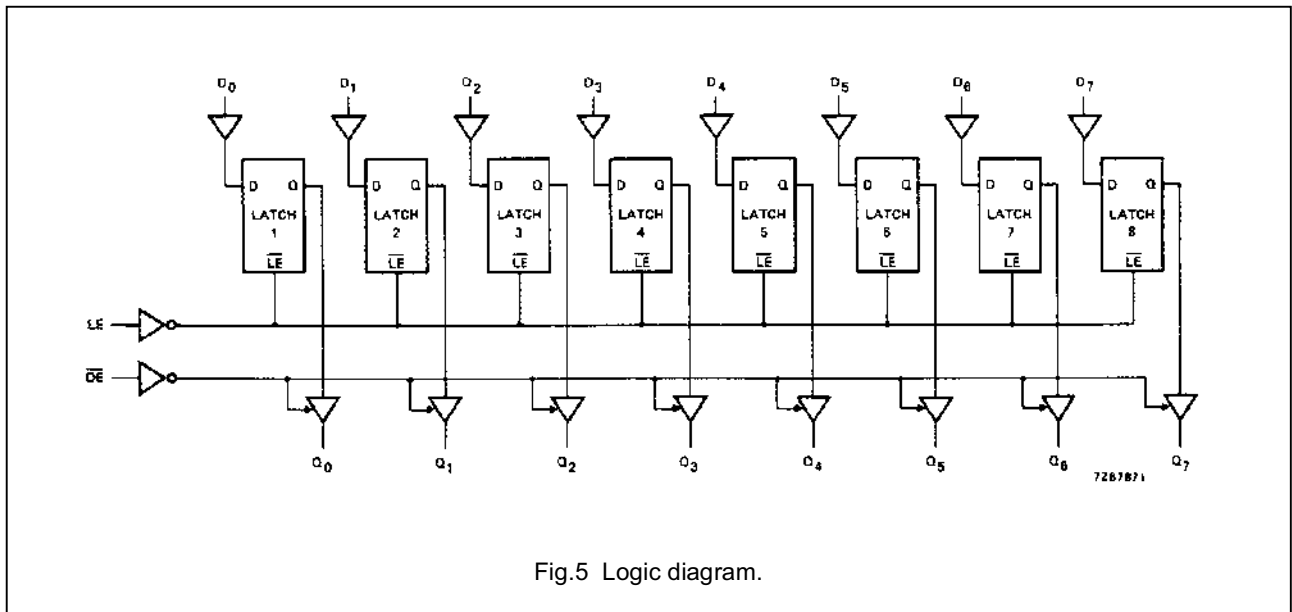

## Octal D-type transparent latch; 3-state

## 74HC/HCT573

**DC CHARACTERISTICS FOR 74HC**

For the DC characteristics see "74HC/HCT/HCU/HCMOS Logic Family Specifications".

Output capability: bus driver

I<sub>CC</sub> category: MSI

**AC CHARACTERISTICS FOR 74HC**

GND = 0 V; t<sub>r</sub> = t<sub>f</sub> = 6 ns; C<sub>L</sub> = 50 pF

SYMBOL	PARAMETER	T <sub>amb</sub> (°C)						UNIT	TEST CONDITIONS		
		74HC							V <sub>CC</sub> (V)	WAVEFORMS	
		+25			-40 to +85		-40 to +125				
		min.	typ.	max.	min.	max.	min.				max.
t <sub>PHL</sub> / t <sub>PLH</sub>	propagation delay D <sub>n</sub> to Q <sub>n</sub>		47 17 14	150 30 26		190 38 33		225 45 38	ns	2.0 4.5 6.0	Fig.6
t <sub>PHL</sub> / t <sub>PLH</sub>	propagation delay LE to Q <sub>n</sub>		50 18 14	150 30 26		190 38 33		225 45 38	ns	2.0 4.5 6.0	Fig.7
t <sub>PZH</sub> / t <sub>PZL</sub>	3-state output enable time $\overline{OE}$ to Q <sub>n</sub>		44 16 13	140 28 24		175 35 30		210 42 36	ns	2.0 4.5 6.0	Fig.8
t <sub>PHZ</sub> / t <sub>PLZ</sub>	3-state output disable time $\overline{OE}$ to Q <sub>n</sub>		55 20 16	150 30 26		190 38 33		225 45 38	ns	2.0 4.5 6.0	Fig.8
t <sub>THL</sub> / t <sub>TLH</sub>	output transition time		14 5 4	60 12 10		75 15 13		90 18 15	ns	2.0 4.5 6.0	Fig.6
t <sub>w</sub>	enable pulse width HIGH	80 16 14	14 5 4		100 20 17		120 24 20		ns	2.0 4.5 6.0	Fig.7
t <sub>su</sub>	set-up time D <sub>n</sub> to LE	50 10 9	11 4 3		65 13 11		75 15 13		ns	2.0 4.5 6.0	Fig.9
t <sub>h</sub>	hold time D <sub>n</sub> to LE	5 5 5	3 1 1		5 5 5		5 5 5		ns	2.0 4.5 6.0	Fig.9

## Octal D-type transparent latch; 3-state

## 74HC/HCT573

**DC CHARACTERISTICS FOR 74HCT**

For the DC characteristics see "74HC/HCT/HCU/HCMOS Logic Family Specifications".

Output capability: bus driver

I<sub>CC</sub> category: MSI

**Note to HCT types**

The value of additional quiescent supply current ( $\Delta I_{CC}$ ) for a unit load of 1 is given in the family specifications.

To determine  $\Delta I_{CC}$  per input, multiply this value by the unit load coefficient shown in the table below.

INPUT	UNIT LOAD COEFFICIENT
D <sub>n</sub>	0.35
LE	0.65
$\overline{OE}$	1.25

**AC CHARACTERISTICS FOR 74HCT**

GND = 0 V; t<sub>r</sub> = t<sub>f</sub> = 6 ns; C<sub>L</sub> = 50 pF

SYMBOL	PARAMETER	T <sub>amb</sub> (°C)								UNIT	TEST CONDITIONS	
		74HCT									V <sub>CC</sub> (V)	WAVEFORMS
		+25			-40 to +85		-40 to +125					
		min.	typ.	max.	min.	max.	min.	max.				
t <sub>PHL</sub> / t <sub>PLH</sub>	propagation delay D <sub>n</sub> to Q <sub>n</sub>		20	35		44		53	ns	4.5	Fig.6	
t <sub>PHL</sub> / t <sub>PLH</sub>	propagation delay LE to Q <sub>n</sub>		18	35		44		53	ns	4.5	Fig.7	
t <sub>PZH</sub> / t <sub>PZL</sub>	3-state output enable time $\overline{OE}$ to Q <sub>n</sub>		17	30		38		45	ns	4.5	Fig.8	
t <sub>PHZ</sub> / t <sub>PLZ</sub>	3-state output disable time $\overline{OE}$ to Q <sub>n</sub>		18	30		38		45	ns	4.5	Fig.8	
t <sub>THL</sub> / t <sub>TLH</sub>	output transition time		5	12		15		18	ns	4.5	Fig.6	
t <sub>W</sub>	enable pulse width HIGH	16	5		20		24		ns	4.5	Fig.7	
t <sub>su</sub>	set-up time D <sub>n</sub> to LE	13	7		16		20		ns	4.5	Fig.9	
t <sub>h</sub>	hold time D <sub>n</sub> to LE	9	4		11		14		ns	4.5	Fig.9	

Octal D-type transparent latch; 3-state

74HC/HCT573

AC WAVEFORMS

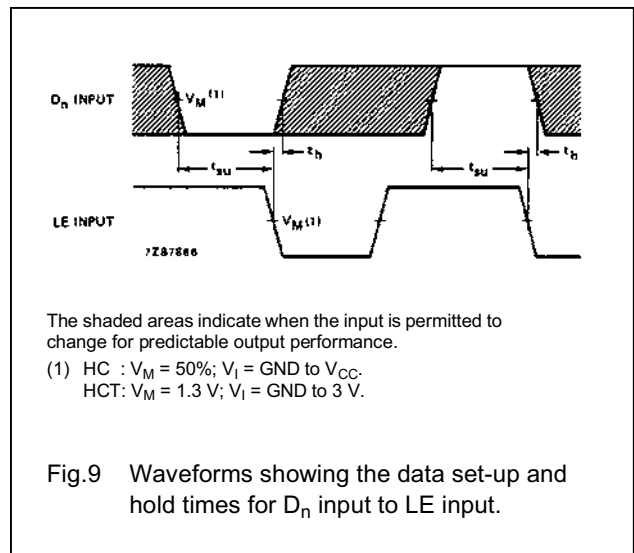
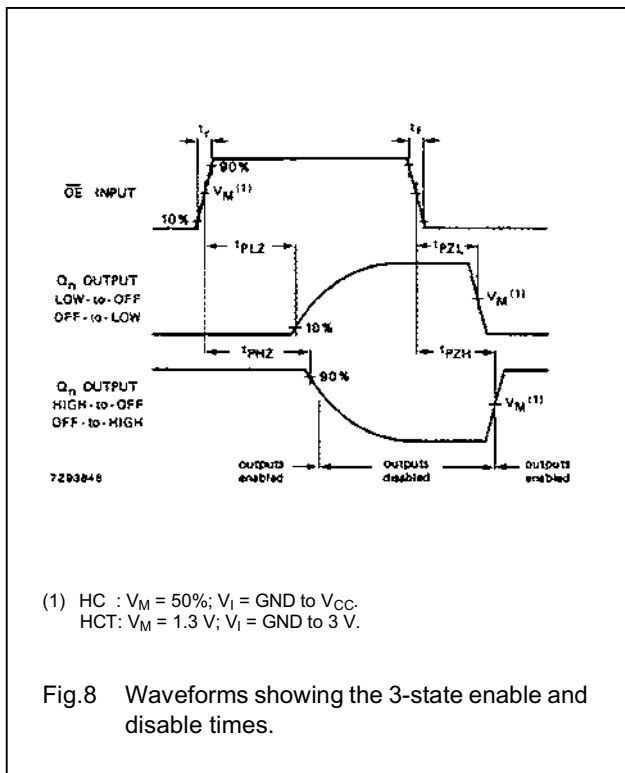
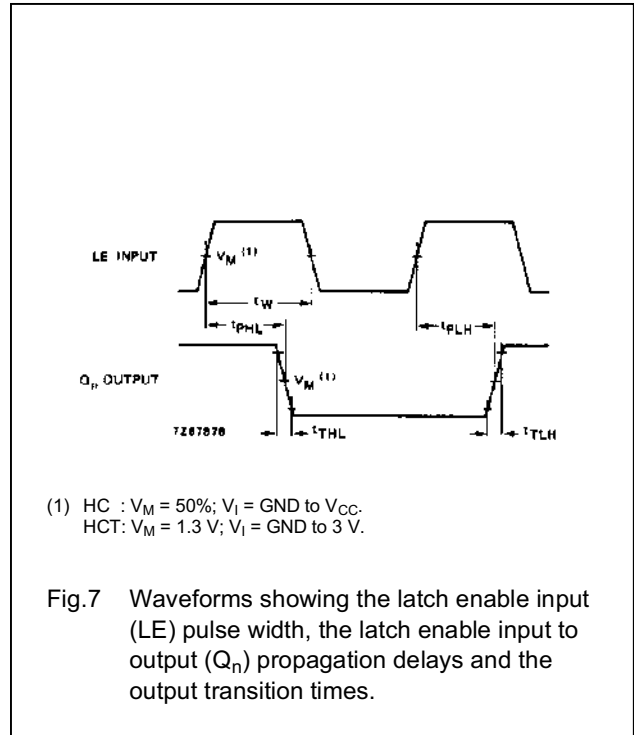
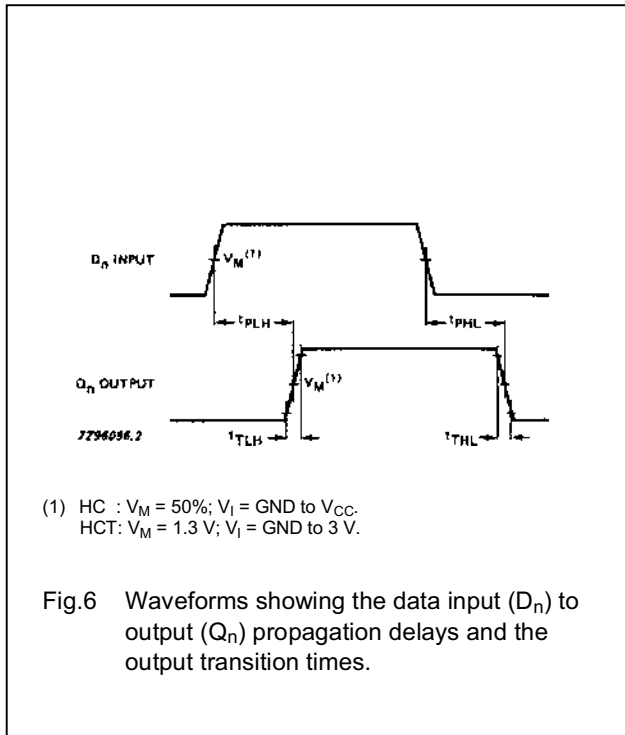

PACKAGE OUTLINES

See "74HC/HCT/HCU/HCMOS Logic Package Outlines".