



DEVICE TYPES

| Part No. | CTR % Min. | Part No. | CTR % Min. |
|----------|------------|----------|------------|
| 4N25 | 20 | MCT2 | 20 |
| 4N26 | 20 | MCT2E | 20 |
| 4N27 | 10 | MCT270 | 50 |
| 4N28 | 10 | MCT271 | 45-90 |
| 4N35 | 100 | MCT272 | 75-150 |
| 4N36 | 100 | MCT273 | 125-250 |
| 4N37 | 100 | MCT274 | 225-400 |
| 4N38 | 10 | MCT275 | 70-90 |
| H11A1 | 50 | MCT276 | 15-60 |
| H11A2 | 20 | MCT277 | 100 |
| H11A3 | 20 | | |
| H11A4 | 10 | | |
| H11A5 | 30 | | |

FEATURES

- Interfaces with Common Logic Families
- Input-output Coupling Capacitance < 0.5 pF
- Industry Standard Dual-in-line 6-pin Package
- Field Effect Stable by TRIOS®
- 5300 V_{RMS} Isolation Test Voltage
- Underwriters Laboratory File #E52744
- VDE #0884 Approval Available with Option 1

APPLICATIONS

- AC Mains Detection
- Reed Relay Driving
- Switch Mode Power Supply Feedback
- Telephone Ring Detection
- Logic Ground Isolation
- Logic Coupling with High Frequency Noise Rejection

Notes:

Designing with data sheet is covered in Application Note 45.

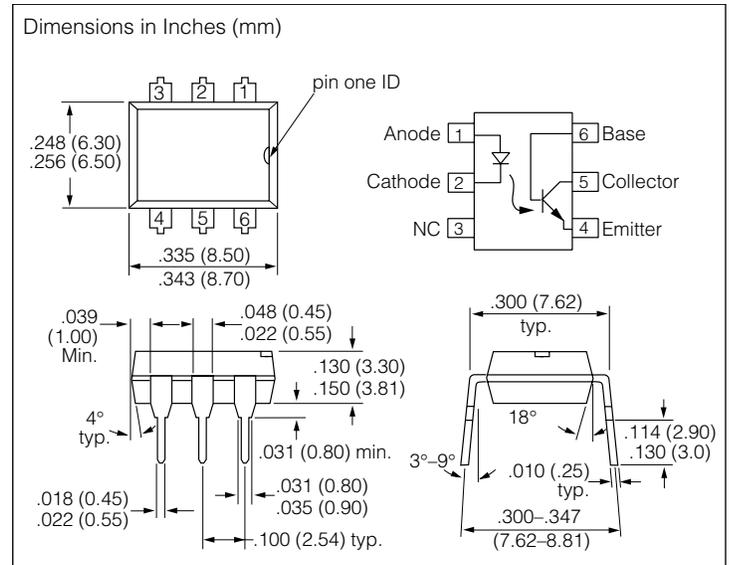

DESCRIPTION

This data sheet presents five families of Vishay Industry Standard Single Channel Phototransistor Couplers. These families include the 4N25/26/27/28 types, the 4N35/36/37/38 couplers, the H11A1/A2/A3/A4/A5, the MCT2/2E, and MCT270/271/272/273/274/275/276/277 devices. Each optocoupler consists of Gallium Arsenide infrared LED and a silicon NPN phototransistor.

These couplers are Underwriters Laboratories (UL) listed to comply with a 5300 V_{RMS} Isolation Test Voltage. This isolation performance is accomplished through Vishay double molding isolation manufacturing process. Compliance to VDE 0884 partial discharge isolation specification is available for these families by ordering option 1. Phototransistor gain stability, in the presence of high isolation voltages, is insured by incorporating a TRansparent IOn Shield (TRIOS)® on the phototransistor substrate. These isolation processes and the Vishay ISO9001 Quality program results in the highest isolation performance available for a commercial plastic phototransistor optocoupler.

The devices are available in lead formed configuration suitable for surface mounting and are available either on tape and reel, or in standard tube shipping containers.

Maximum Ratings $T_A=25^\circ\text{C}$

Emitter

Reverse Voltage 6.0 V
 Forward Current 60 mA
 Surge Current ($t \leq 10 \mu\text{s}$) 2.5 A
 Power Dissipation 100 mW

Detector

Collector-Emitter Breakdown Voltage 70 V
 Emitter-Base Breakdown Voltage 7.0 V
 Collector Current 50 mA
 Collector Current ($t < 1.0 \text{ ms}$) 100 mA
 Power Dissipation 150 mW

Package

Isolation Test Voltage 5300 V_{RMS}
 Creepage $\geq 7.0 \text{ mm}$
 Clearance $\geq 7.0 \text{ mm}$
 Isolation Thickness between Emitter and Detector $\geq 0.4 \text{ mm}$
 Comparative Tracking Index per DIN IEC 112/VDE0303, part 1 175
 Isolation Resistance
 $V_{\text{IO}}=500 \text{ V}, T_A=25^\circ\text{C}$ $10^{12} \Omega$
 $V_{\text{IO}}=500 \text{ V}, T_A=100^\circ\text{C}$ $10^{11} \Omega$
 Storage Temperature -55°C to $+150^\circ\text{C}$
 Operating Temperature -55°C to $+100^\circ\text{C}$
 Junction Temperature 100°C
 Soldering Temperature (max. 10 s, dip soldering:
 distance to seating plane $\geq 1.5 \text{ mm}$) 260°C

4N25/26/27/28—Characteristics $T_A=25^\circ\text{C}$

| Emitter | | Symbol | Min. | Typ. | Max. | Unit | Condition |
|---------------------------------------|--------------------|----------------------|------|-----------|-----------|------------------|--|
| Forward Voltage* | | V_F | — | 1.3 | 1.5 | V | $I_F=50 \text{ mA}$ |
| Reverse Current* | | I_R | — | 0.1 | 100 | μA | $V_R=3.0 \text{ V}$ |
| Capacitance | | C_O | — | 25 | — | pF | $V_R=0$ |
| Detector | | | | | | | |
| Breakdown Voltage* | Collector-Emitter | BV_{CEO} | 30 | — | — | V | $I_C=1.0 \text{ mA}$ |
| | Emitter-Collector | BV_{ECO} | 7.0 | — | — | | $I_E=100 \mu\text{A}$ |
| | Collector-Base | BV_{CBO} | 70 | — | — | | $I_C=100 \mu\text{A}$ |
| $I_{\text{CEO}}(\text{dark})^*$ | 4N25/26/27 4N28 | — | — | 5.0 10 | 50 100 | nA | $V_{\text{CE}}=10 \text{ V}$, (base open) |
| $I_{\text{CBO}}(\text{dark})^*$ | | — | — | 2.0 | 20 | nA | $V_{\text{CB}}=10 \text{ V}$, (emitter open) |
| Capacitance, Collector-Emitter | | C_{CE} | — | 6.0 | — | pF | $V_{\text{CE}}=0$ |
| Package | | | | | | | |
| DC Current Transfer Ratio* | 4N25/26 | CTR | 20 | 50 | — | % | $V_{\text{CE}}=10 \text{ V}$, $I_F=10 \text{ mA}$ |
| | 4N27/28 | | 10 | 30 | — | | |
| Isolation Voltage* | 4N25 | V_{IO} | 2500 | — | — | V | Peak, 60 Hz |
| | 4N26/27 | | 1500 | — | — | | |
| | 4N28 | | 500 | — | — | | |
| Saturation Voltage, Collector-Emitter | | $V_{\text{CE(sat)}}$ | — | — | 0.5 | V | $I_{\text{CE}}=2.0 \text{ mA}$, $I_F=50 \text{ mA}$ |
| Resistance, Input to Output* | | R_{IO} | 100 | — | — | $\text{G}\Omega$ | $V_{\text{IO}}=500 \text{ V}$ |
| Coupling Capacitance | | C_{IO} | — | 0.5 | — | pF | $f=1.0 \text{ MHz}$ |
| Rise and Fall Times | | t_r, t_f | — | 2.0 | — | μs | $I_F=10 \text{ mA}$ $V_{\text{CE}}=10 \text{ V}$, $R_L=100 \Omega$ |

* Indicates JEDEC registered values

4N35/36/37/38—Characteristics $T_A=25^\circ\text{C}$

| Emitter | | Symbol | Min. | Typ. | Max. | Unit | Condition |
|---------------------------------------|------------|-------------------|-----------|------|------------|---------------|--|
| Forward Voltage* | | V_F | 0.9 | 1.3 | 1.5 1.7 | V | $I_F=10\text{ mA}$ $I_F=10\text{ mA}, T_A=-55^\circ\text{C}$ |
| Reverse Current* | | I_R | | 0.1 | 10 | μA | $V_R=6.0\text{ V}$ |
| Capacitance | | C_O | | 25 | — | pF | $V_R=0, f=1.0\text{ MHz}$ |
| Detector | | | | | | | |
| Breakdown Voltage, Collector-Emitter* | 4N35/36/37 | BV_{CEO} | 30 | — | — | V | $I_C=1.0\text{ mA}$ |
| | 4N38 | | 80 | — | — | | |
| Breakdown Voltage, Emitter-Collector* | | BV_{ECO} | 7.0 | — | — | V | $I_E=100\ \mu\text{A}$ |
| Breakdown Voltage, Collector-Base* | 4N35/36/37 | BV_{CBO} | 70 | — | — | V | $I_C=100\ \mu\text{A}, I_B=1.0\ \mu\text{A}$ |
| | 4N38 | | 80 | — | — | — | |
| Leakage Current, Collector-Emitter* | 4N35/36/37 | I_{CEO} | — | 5.0 | 50 | nA | $V_{CE}=10\text{ V}, I_F=0$ |
| | 4N38 | | — | — | 50 | | $V_{CE}=60\text{ V}, I_F=0$ |
| Leakage Current, Collector-Emitter* | 4N35/36/37 | I_{CEO} | — | — | 500 | μA | $V_{CE}=30\text{ V}, I_F=0, T_A=100^\circ\text{C}$ |
| | 4N38 | | — | 6.0 | — | | $V_{CE}=60\text{ V}, I_F=0, T_A=100^\circ\text{C}$ |
| Capacitance, Collector-Emitter | | C_{CE} | — | 6.0 | — | pF | $V_{CE}=0$ |
| Package | | | | | | | |
| DC Current Transfer Ratio* | 4N35/36/37 | CTR | 100 | — | — | % | $V_{CE}=10\text{ V}, I_F=10\text{ mA},$ |
| | 4N38 | | 20 | — | — | | $V_{CE}=1.0\text{ V}, I_F=20\text{ mA}$ |
| DC Current Transfer Ratio* | 4N35/36/37 | CTR | 40 | 50 | — | % | $V_{CE}=10\text{ V}, I_F=10\text{ mA},$ $T_A=-55\text{ to }100^\circ\text{C}$ |
| | 4N38 | — | — | 30 | — | | |
| Resistance, Input to Output* | | R_{IO} | 10^{11} | — | — | Ω | $V_{IO}=500\text{ V}$ |
| Coupling Capacitance | | C_{IO} | — | 0.5 | — | pF | $f=1.0\text{ MHz}$ |
| Switching Time* | | t_{ON}, t_{OFF} | — | 10 | — | μs | $I_C=2.0\text{ mA}, R_L=100\ \Omega, V_{CC}=10\text{ V}$ |

* Indicates JEDEC registered value

H11A1 through H11A5—Characteristics $T_A=25^\circ\text{C}$

| Emitter | | Symbol | Min. | Typ. | Max. | Unit | Condition |
|---------------------------------------|-------------|-------------------|------|------|------|---------------|--|
| Forward Voltage | H11A1–H11A4 | V_F | — | 1.1 | 1.5 | V | $I_F=10\text{ mA}$ |
| | H11A5 | | — | 1.1 | 1.7 | | |
| Reverse Current | | I_R | — | — | 10 | μA | $V_R=3.0\text{ V}$ |
| Capacitance | | C_O | — | 50 | — | pF | $V_R=0, f=1.0\text{ MHz}$ |
| Detector | | | | | | | |
| Breakdown Voltage, Collector-Emitter | | BV_{CEO} | 30 | — | — | V | $I_C=1.0\text{ mA}, I_F=0\text{ mA}$ |
| Breakdown Voltage, Emitter-Collector | | BV_{ECO} | 7.0 | — | — | V | $I_E=100\ \mu\text{A}, I_F=0\text{ mA}$ |
| Breakdown Voltage, Collector-Base | | BV_{CBO} | 70 | — | — | V | $I_C=10\ \mu\text{A}, I_F=0\text{ mA}$ |
| Leakage Current, Collector-Emitter | | I_{CEO} | — | 5.0 | 50 | nA | $V_{CE}=10\text{ V}, I_F=0\text{ mA}$ |
| Capacitance, Collector-Emitter | | C_{CE} | — | 6.0 | — | pF | $V_{CE}=0$ |
| Package | | | | | | | |
| DC Current Transfer Ratio | H11A1 | CTR | 50 | — | — | % | $V_{CE}=10\text{ V}, I_F=10\text{ mA}$ |
| | H11A2/3 | | 20 | — | — | | |
| | H11A4 | | 10 | — | — | | |
| | H11A5 | | 30 | — | — | | |
| Saturation Voltage, Collector-Emitter | | V_{CESat} | — | — | 0.4 | V | $I_{CE}=0.5\text{ mA}, I_F=10\text{ mA}$ |
| Capacitance, Input to Output | | C_{IO} | — | 0.5 | — | pF | — |
| Switching Time | | t_{ON}, t_{OFF} | — | 3.0 | — | μs | $I_C=2.0\text{ mA}, R_L=100\ \Omega, V_{CE}=10\text{ V}$ |

MCT2/MCT2E—Characteristics $T_A=25^\circ\text{C}$

| Emitter | | Symbol | Min. | Typ. | Max. | Unit | Condition |
|--------------------------------|-------------------|-------------------|------|------|------|------------------|--|
| Forward Voltage | | V_F | — | 1.1 | 1.5 | V | $I_F=20\text{ mA}$ |
| Reverse Current | | I_R | — | — | 10 | μA | $V_R=3.0\text{ V}$ |
| Capacitance | | C_O | — | 25 | — | pF | $V_R=0, f=1.0\text{ MHz}$ |
| Detector | | | | | | | |
| Breakdown Voltage | Collector-Emitter | BV_{CEO} | 30 | — | — | V | $I_C=1.0\text{ mA}, I_F=0\text{ mA}$ |
| | Emitter-Collector | BV_{ECO} | 7.0 | — | — | | $I_E=100\text{ }\mu\text{A}, I_F=0\text{ mA}$ |
| | Collector-Base | BV_{CBO} | 70 | — | — | | $I_C=10\text{ }\mu\text{A}, I_F=0\text{ mA}$ |
| Leakage Current | Collector-Emitter | I_{CBO} | — | 5.0 | 50 | nA | $V_{CE}=10\text{ V}, I_F=0$ |
| | Collector-Base | I_{CBO} | — | — | 20 | | |
| Capacitance, Collector-Emitter | — | C_{CE} | — | 10 | — | pF | $V_{CE}=0$ |
| Package | | | | | | | |
| DC Current Transfer Ratio | | CTR | 20 | 60 | — | % | $V_{CE}=10\text{ V}, I_F=10\text{ mA}$ |
| Capacitance, Input to Output | | C_{IO} | — | 0.5 | — | pF | — |
| Resistance, Input to Output | | R_{IO} | — | 100 | — | $\text{G}\Omega$ | — |
| Switching Time | | t_{ON}, t_{OFF} | — | 3.0 | — | μs | $I_C=2.0\text{ mA}, R_L=100\text{ }\Omega, V_{CE}=10\text{ V}$ |

MCT270 through MCT277—Characteristics $T_A=25^\circ\text{C}$

| Emitter | | Symbol | Min. | Typ. | Max. | Unit | Condition |
|---|-------------------|-------------------|------|-----------|------|---------------|---|
| Forward Voltage | | V_F | — | — | 1.5 | V | $I_F=20\text{ mA}$ |
| Reverse Current | | I_R | — | — | 10 | μA | $V_R=3.0\text{ V}$ |
| Capacitance | | C_O | — | 25 | — | pF | $V_R=0, f=1.0\text{ MHz}$ |
| Detector | | | | | | | |
| Breakdown Voltage | Collector-Emitter | BV_{CEO} | 30 | — | — | V | $I_C=10\text{ }\mu\text{A}, I_F=0\text{ mA}$ |
| | Emitter-Collector | BV_{ECO} | 7.0 | — | — | | $I_E=10\text{ }\mu\text{A}, I_F=0\text{ mA}$ |
| | Collector-Base | BV_{CBO} | 70 | — | — | | $I_C=10\text{ }\mu\text{A}, I_F=0\text{ mA}$ |
| Leakage Current, Collector-Emitter | | I_{CEO} | — | — | 50 | nA | $V_{CE}=10\text{ V}, I_F=0\text{ mA}$ |
| Package | | | | | | | |
| DC Current Transfer Ratio | MCT270 | CTR | 50 | — | — | % | $V_{CE}=10\text{ V}, I_F=10\text{ mA}$ |
| | MCT271 | | 45 | — | 90 | | |
| | MCT272 | | 75 | — | 150 | | |
| | MCT273 | | 125 | — | 250 | | |
| | MCT274 | | 225 | — | 400 | | |
| | MCT275 | | 70 | — | 210 | | |
| | MCT276 | | 15 | — | 60 | | |
| | MCT277 | | 100 | — | — | | |
| Current Transfer Ratio, Collector-Emitter | MCT271–276 | CTR_{CE} | 12.5 | — | — | % | $V_{CE}=0.4\text{ V}, I_F=16\text{ mA}$ |
| | MCT277 | | 40 | — | — | | |
| Collector-Emitter Saturation Voltage | | V_{CEsat} | — | — | 0.4 | V | $I_{CE}=2.0\text{ mA}, I_F=16\text{ mA}$ |
| Capacitance, Input to Output | | C_{IO} | — | 0.5 | — | pF | — |
| Resistance, Input to Output | | R_{IO} | — | 10^{12} | — | Ω | $V_{IO}=500\text{ VDC}$ |
| Switching Time | MCT270/272 | t_{ON}, t_{OFF} | — | — | 10 | μs | $I_C=2.0\text{ mA}, R_L=100\text{ }\Omega, V_{CE}=5.0\text{ V}$ |
| | MCT271 | | — | — | 7.0 | | |
| | MCT273 | | — | — | 20 | | |
| | MCT274 | | — | — | 25 | | |
| | MCT275/277 | | — | — | 15 | | |
| | MCT276 | | — | — | 3.5 | | |

Figure 1. Forward Voltage vs. Forward Current

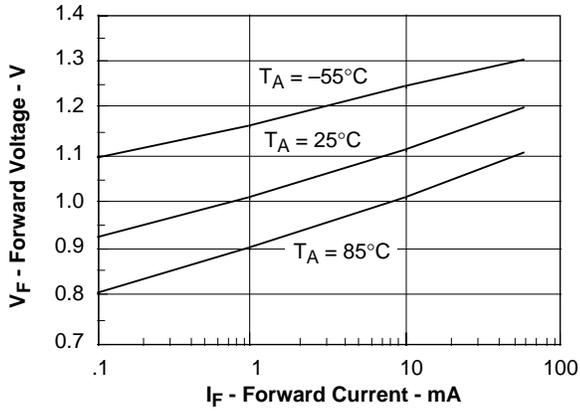

Figure 2. Normalized Non-saturated and Saturated CTR, T_A=25°C vs. LED Current

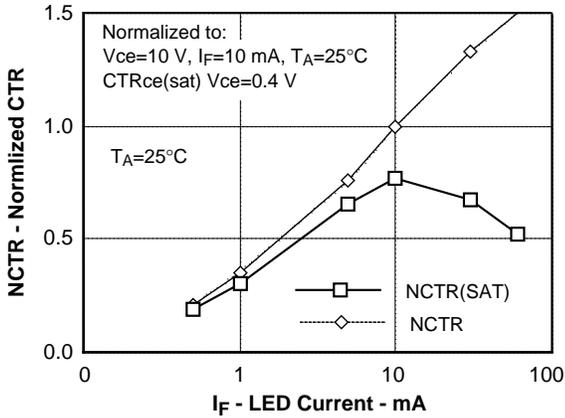

Figure 3. Normalized Non-saturated and Saturated CTR, T_A=50°C vs. LED Current

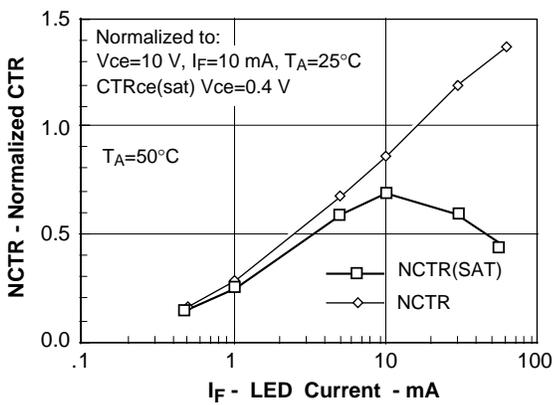

Figure 4. Normalized Non-saturated and Saturated CTR, T_A=70°C vs. LED Current

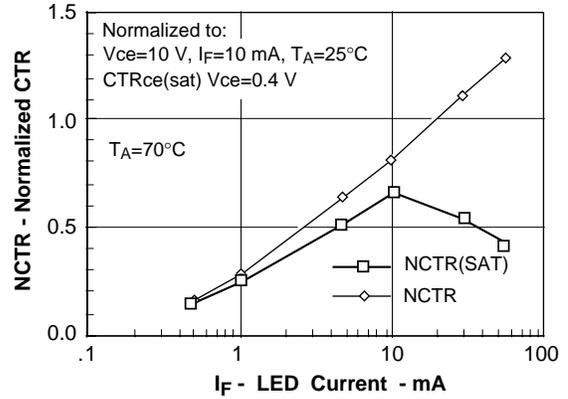

Figure 5. Normalized Non-saturated and Saturated CTR, T_A=85°C vs. LED Current

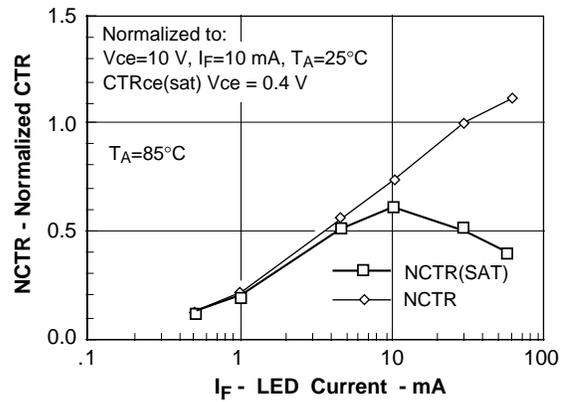

Figure 6. Collector-emitter Current vs. Temperature and LED Current

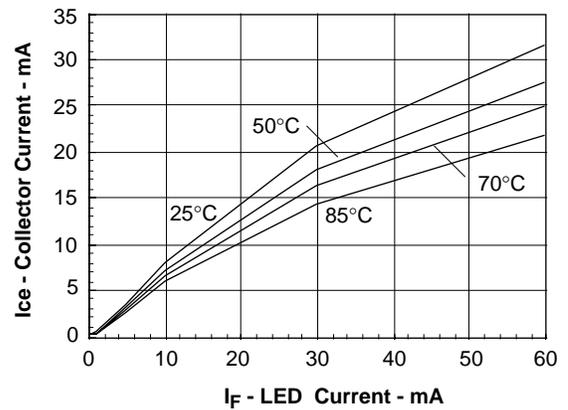

Figure 7. Collector-emitter Leakage Current vs. Temp.

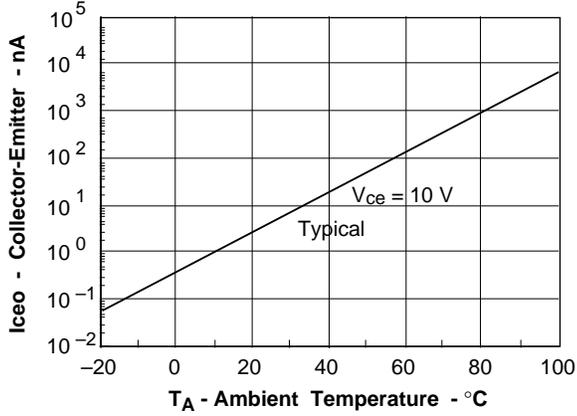

Figure 8. Normalized CTRcb vs. LED Current and Temp.

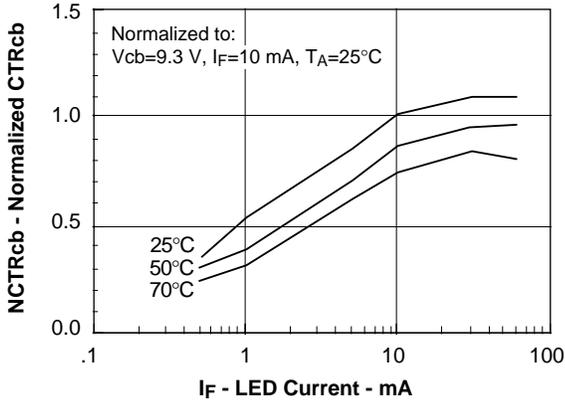

Figure 9. Normalized Photocurrent vs. I_F and Temp.

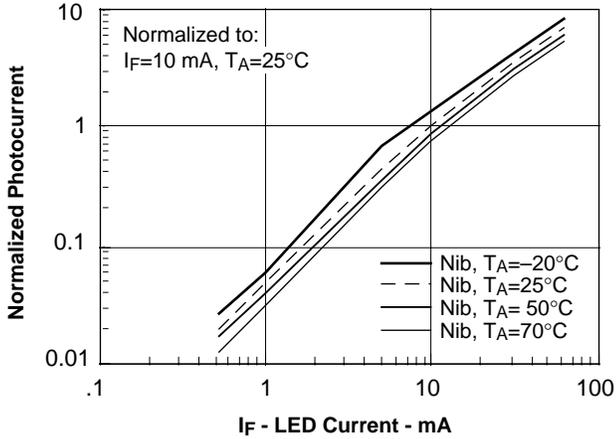

Figure 13. Switching Timing

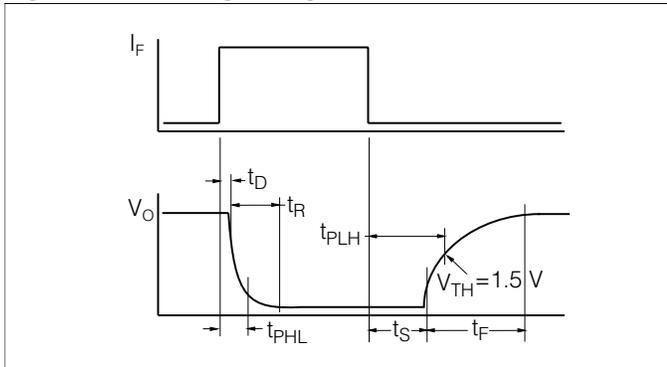

Figure 10. Normalized Non-saturated HFE vs. Base Current and Temperature

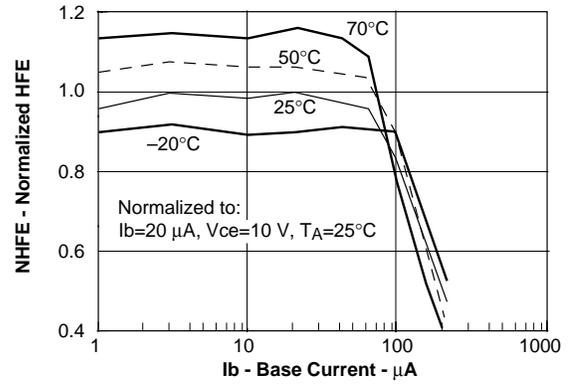

Figure 11. Normalized HFE vs. Base Current and Temp.

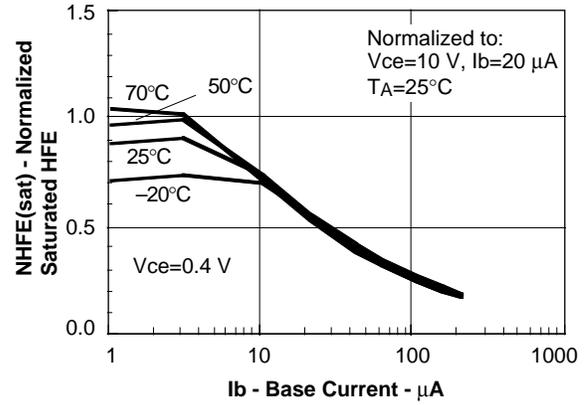

Figure 12. Propagation Delay vs. Collector Load Resistor

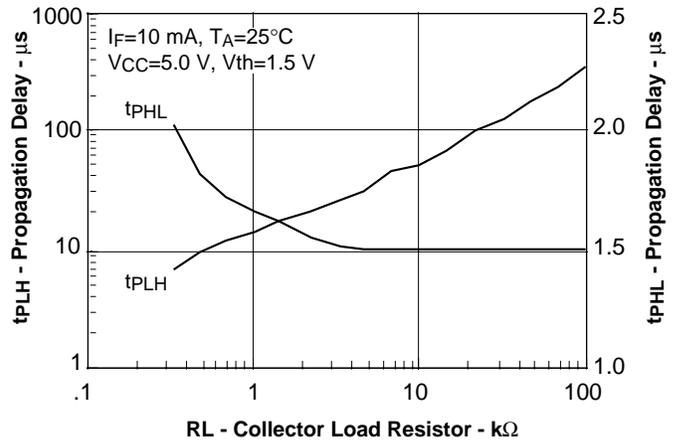

Figure 14. Switching Schematic

