

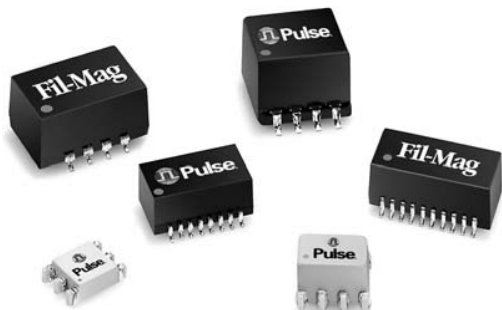



SURFACE MOUNT COMMON MODE CHOKES

Suited for LAN and Telecom Applications



-  Reduces radiated EMI emissions
-  Filters common mode noise for EMI reduction
-  Common mode attenuation from 100 kHz to 1 GHz
-  Tape & Reel packaging available for surface mount parts*

Electrical Specifications @ 25°C

Part Number	No. of Lines	Primary Inductance OCL (µH MIN)	Common Mode Attenuation (dB TYP)									DCR (Ω MAX)	Page Number of Mech. & Schem.
			100 KHz	1 MHz	10 MHz	30 MHz	50 MHz	100 MHz	300 MHz	500 MHz	1 GHz		
PE-68624	2	47	11	27	40	44	42	36	26	17	—	0.40	2
PE-65855	2	4700	41	43	49	39	34	26	20	12	1.0	1.0	4
B2013	2	6300	46	47	43	32	25	29	21	14	16	1.0	3
B4003	2	4700	42	41	48	38	33	21	22	23	17	1.0	6
R0003	3	20	6	14	27	30	30	30	30	28	25	0.40	2
23Z87SM	3	69	9	24	31	30	29	27	21	16	—	0.20	4
PE-65857	4	22.5	7	20	30	37	38	34	24	13	—	0.22	4
PE-68627	4	24	8	21	32	36	37	36	30	20	—	0.25	4
T8003	4	33	9	13	32	32	30	27	16	17	13	0.20	6
23Z4000SMD	4	36	7	23	35	38	38	36	29	24	—	0.50	5
PE-65738	4	37	8	21	28	28	28	27	25	22	—	0.30	3
PE-65854	4	47	3	19	32	36	35	29	12	6	—	0.40	3
23Z104SM	4	68	8	22	28	28	27	25	20	15	—	0.20	5
PE-67540	4	100	14	33	44	48	49	44	34	29	20	0.60	4
PE-65853	4	4700	40	51	38	30	25	20	14	13	—	1.20	3
PE-68602	6	21	6	19	28	34	35	36	34	29	1	0.35	3
23Z106SM	6	68	8	22	29	30	30	29	24	19	—	0.20	5
PE-69011	8	36	8	24	36	39	35	29	18	11	—	0.35	3
23Z105SM	8	68	8	24	30	29	27	24	16	11	—	0.20	5
23Z109SM	10	7.5	4	9	20	25	26	24	16	11	—	0.20	5
T8008	16	47	7	27	40	44	42	36	26	—	—	0.40	6

* When ordering Tape & Reel packaging, add a "T" at the end of the part number (i.e. PE-65738T or 23Z106SMT).

NOTE: Additional common mode chokes are available. Please contact Applications Engineering.

Mechanicals

PE-68624, R0003

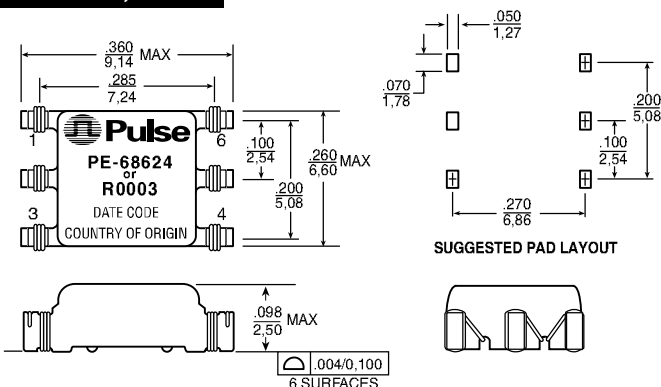

Schematics

R0003



Connect unused pin to logic ground for optimum performance.

PE-68624



SURFACE MOUNT COMMON MODE CHOKES

Suited for LAN and Telecom Applications



Mechanicals

Schematics

PE-65855

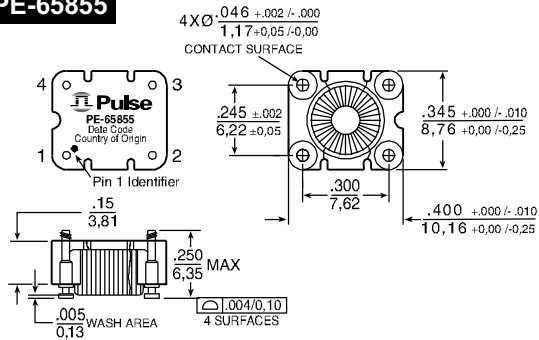

PE-65855

Dimensions: $\frac{\text{Inches}}{\text{mm}}$
Unless otherwise specified,
all tolerances are $\pm \frac{.010}{0,25}$

Weight0.69 grams
Tape & Reel800/reel
Tube40 /tube



PE-65857, PE-67540

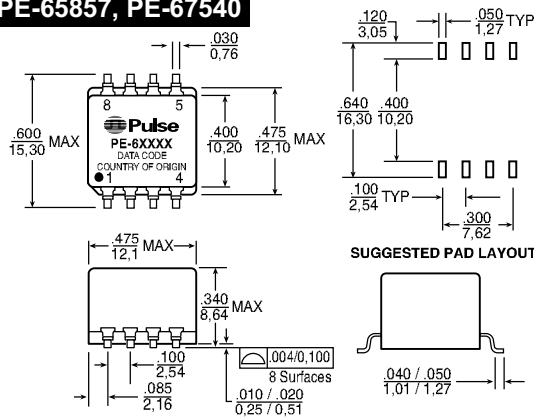

Dimensions: $\frac{\text{Inches}}{\text{mm}}$
Unless otherwise specified,
all tolerances are $\pm \frac{.010}{0,25}$

Weight2.0 grams
Tape & Reel250/reel
Tube40/tube

PE-65857

PE-67540

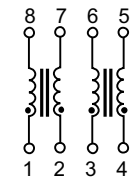
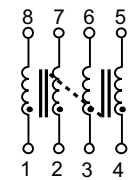

PE-68627

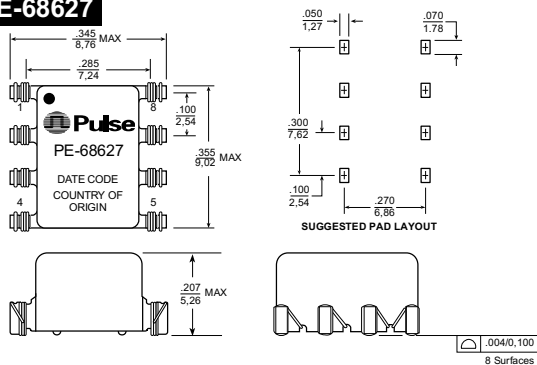

PE-68627

Dimensions: $\frac{\text{Inches}}{\text{mm}}$
Unless otherwise specified,
all tolerances are $\pm \frac{.010}{0,25}$

Weight0.3 grams
Tape & Reel1500/reel
Tube55/tube

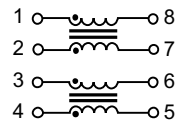

23Z87SM

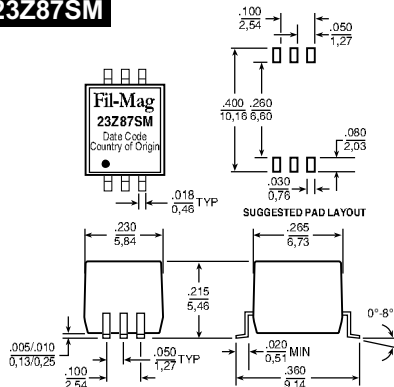

23Z87SM

Dimensions: $\frac{\text{Inches}}{\text{mm}}$
Unless otherwise specified,
all tolerances are $\pm \frac{.005}{0,13}$

Weight0.5 grams
Tape & Reel750/reel
Tube100/tube



SURFACE MOUNT COMMON MODE CHOKES

Suited for LAN and Telecom Applications



Mechanicals

Schematics

23Z104SM

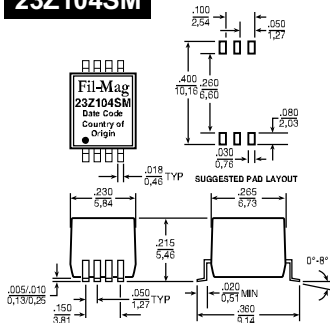

Dimensions: $\frac{\text{Inches}}{\text{mm}}$
Unless otherwise specified,
all tolerances are $\pm .005$
 $0,13$

Weight 0.5 grams
Tape & Reel 750/reel
Tube 100/tube

23Z104SM

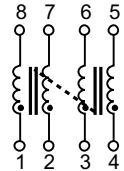

23Z105SM, 23Z106SM

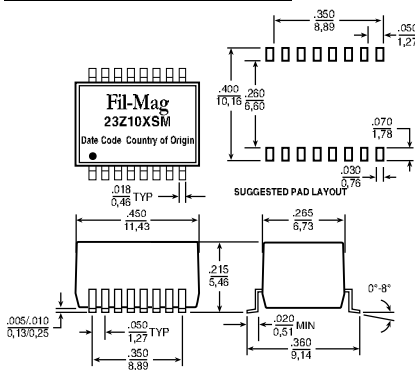

Dimensions: $\frac{\text{Inches}}{\text{mm}}$
Unless otherwise specified,
all tolerances are $\pm .005$
 $0,13$

23Z105SM 23Z106SM
Weight 0.8 grams 1.0 grams
Tape & Reel 750/reel 750/reel
Tube 50/tube 50/tube

23Z105SM

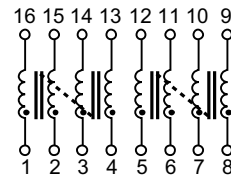

23Z106SM

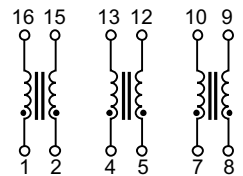

23Z109SM

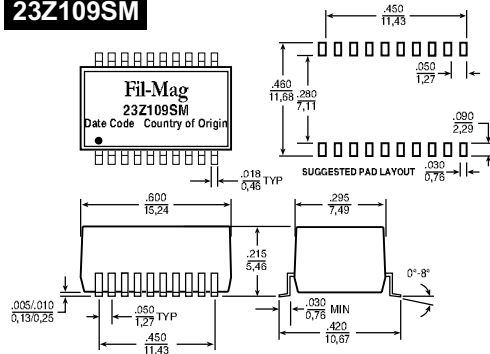

Dimensions: $\frac{\text{Inches}}{\text{mm}}$
Unless otherwise specified,
all tolerances are $\pm .005$
 $0,13$

Weight 1.3 grams
Tape & Reel 500/reel
Tube 38/tube

23Z109SM

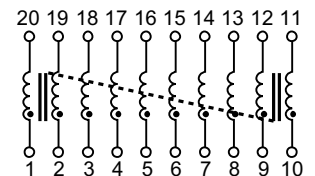

23Z4000SMD

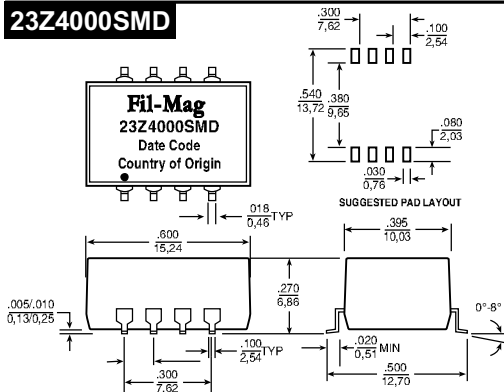

Dimensions: $\frac{\text{Inches}}{\text{mm}}$
Unless otherwise specified,
all tolerances are $\pm .005$
 $0,13$

Weight 2.1 grams
Tape & Reel 350/reel
Tube 38/tube

23Z4000SMD

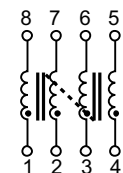

SURFACE MOUNT COMMON MODE CHOKES

Suited for LAN and Telecom Applications



Mechanicals

Schematics

T8003

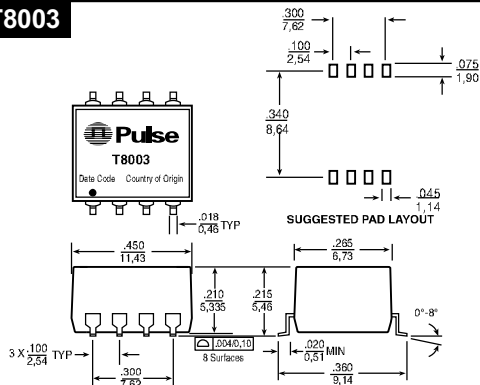

Dimensions: $\frac{\text{Inches}}{\text{mm}}$
Unless otherwise specified,
all tolerances are $\pm \frac{.005}{0,13}$

Weight 0.84 grams
Tape & Reel750/reel
Tube 100/tube

T8003

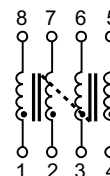

T8055

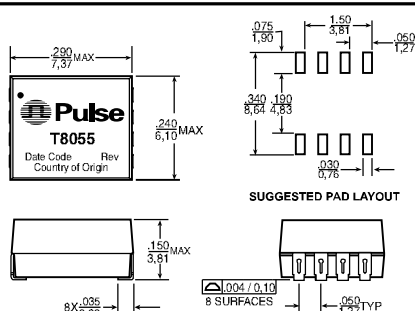

Dimensions: $\frac{\text{Inches}}{\text{mm}}$
Unless otherwise specified,
all tolerances are $\pm \frac{.010}{0,25}$

Weight 0.2 grams
Tape & Reel1750/reel
Tube 80/tube

T8055

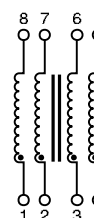

B4003

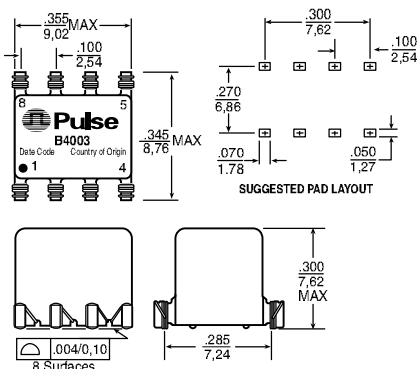

Dimensions: $\frac{\text{Inches}}{\text{mm}}$
Unless otherwise specified,
all tolerances are $\pm \frac{.010}{0,25}$

Weight 1.0 grams
Tape & Reel425/reel
Tube 50/tube

B4003

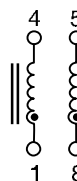

T8008

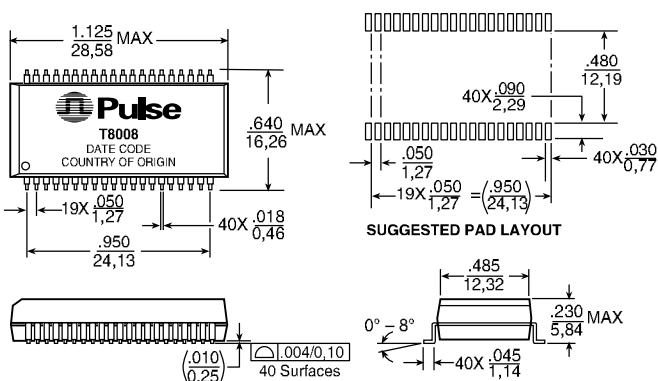

Dimensions: $\frac{\text{Inches}}{\text{mm}}$
Unless otherwise specified,
all tolerances are $\pm \frac{.010}{0,25}$

Weight 4.0 grams
Tape & Reel250/reel
Tube 15/tube

T8008

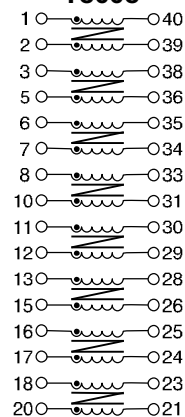



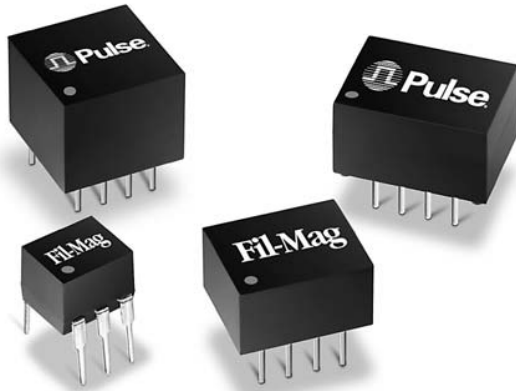

NOTE: The common mode test circuit for surface mount is the same as for through hole and is on the back page.

THROUGH HOLE COMMON MODE CHOKES

Suited for LAN and Telecom Applications



-  Reduces radiated EMI emissions
-  Filters common mode noise for EMI reduction
-  Common mode attenuation from 100 KHz to 1 GHz
-  Tube packaging available for through hole parts

Electrical Specifications @ 25°C

Part Number	No. of Lines	Primary Inductance OCL (μH MIN)	Common Mode Attenuation (dB TYP)										DCR (Ω MAX)	Page Number of Mech. & Schem.
			100 KHz	1 MHz	10 MHz	30 MHz	50 MHz	100 MHz	300 MHz	500 MHz	1 GHz			
PE-65944	2	24	1	14	28	32	33	28	13	5	—	0.30	9	
23Z107	2	68	8	25	33	32	30	27	18	12	—	0.20	11	
PE-67531	2	140	14	34	45	49	50	47	38	32	25	0.60	9	
B2005	2	9000	47	47	41	30	22	33	21	15	15	1.0	10	
23Z87	3	69	8	22	29	29	28	26	20	15	—	0.20	10	
PE-65554	4	24	—	21	32	38	39	34	24	13	—	0.30	8	
42Z4000	4	36	8	24	37	40	40	38	30	24	—	0.20	11	
PE-67501	4	50	14	34	45	49	50	47	20	15	10	0.30	9	
PE-68002	4	68	7	24	37	41	42	40	31	27	—	0.35	9	
23Z104	4	85	8	23	29	29	28	25	17	11	—	0.20	10	
PE-67539	4	140	14	33	44	48	48	43	33	28	19	0.60	9	
PE-65542	4	1000	28	41	42	32	22	—	—	—	—	0.70	8	
PT5039	4	3600	42	43	42	32	27	17	15	9	13	0.50	8	
J0010D11	4	—	9	13	32	35	35	29	13	24	19	0.50	12	
PE-65950	4	4700±30%	40	51	37	28	23	20	—	—	—	1.00	8	
PE-65541	4	6000	44	54	33	32	29	—	—	—	—	1.40	8	
PE-68613	4	3290	40	51	37	28	23	20	—	—	—	1.00	11	
PE-64683	6	25	6	18	32	38	37	32	21	17	—	0.35	8	
23Z106	6	85	8	23	30	29	28	27	21	15	—	0.20	10	

THROUGH HOLE COMMON MODE CHOKES

Suited for LAN and Telecom Applications



Mechanicals

Schematics

PE-64683

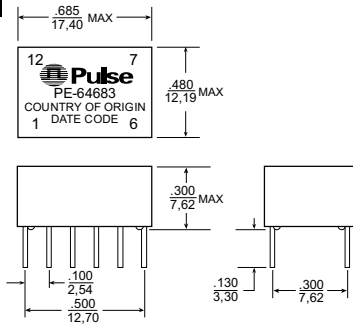

PE-64683

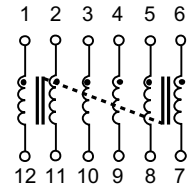

Dimensions: $\frac{\text{Inches}}{\text{mm}}$
 Unless otherwise specified,
 all tolerances are $\pm \frac{.010}{0,25}$

Weight0.27 grams
 Tube30/tube

PE-65541, PE-65542, PE-65950

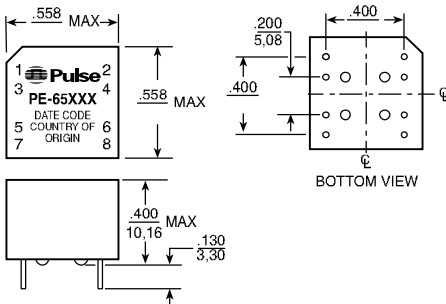

PE-65541 PE-65542 PE-65950

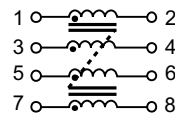

Dimensions: $\frac{\text{Inches}}{\text{mm}}$
 Unless otherwise specified,
 all tolerances are $\pm \frac{.010}{0,25}$

Weight0.38 grams
 Tube35/tube

PE-65554

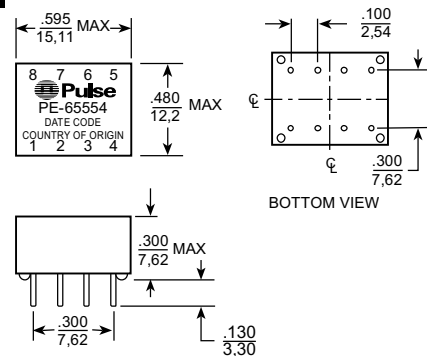

PE-65554

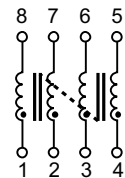

Dimensions: $\frac{\text{Inches}}{\text{mm}}$
 Unless otherwise specified,
 all tolerances are $\pm \frac{.010}{0,25}$

Weight2.5 grams
 Tube35/tube

PT5039

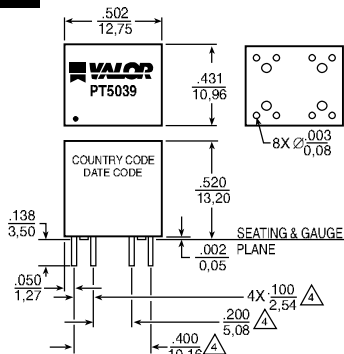

PT5039

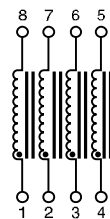

Dimensions: $\frac{\text{Inches}}{\text{mm}}$
 Unless otherwise specified,
 all tolerances are $\pm \frac{.010}{0,25}$

Weight2.5 grams
 Tube35/tube

THROUGH HOLE COMMON MODE CHOKES

Suited for LAN and Telecom Applications



Mechanicals

Schematics

PE-65944

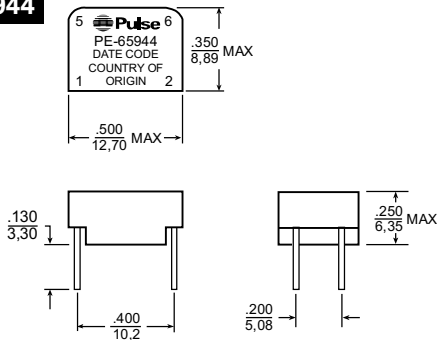

Dimensions: $\frac{\text{Inches}}{\text{mm}}$
Unless otherwise specified,
all tolerances are $\pm \frac{.010}{0,25}$

PE-65944



Weight 1.07 grams
Tube30/tube

PE-67501, PE-67539

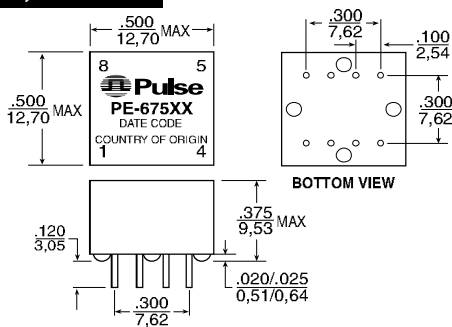

Dimensions: $\frac{\text{Inches}}{\text{mm}}$
Unless otherwise specified,
all tolerances are $\pm \frac{.010}{0,25}$

PE-67501 PE-67539

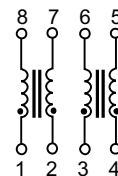

Weight 2.4 grams
Tube40/tube

PE-67531

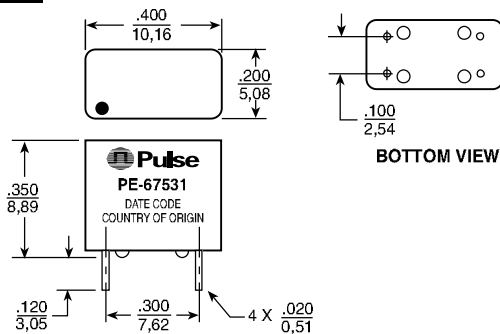

Dimensions: $\frac{\text{Inches}}{\text{mm}}$
Unless otherwise specified,
all tolerances are $\pm \frac{.010}{0,25}$

PE-67531



Weight 0.76 grams
Tube40/tube

PE-68002

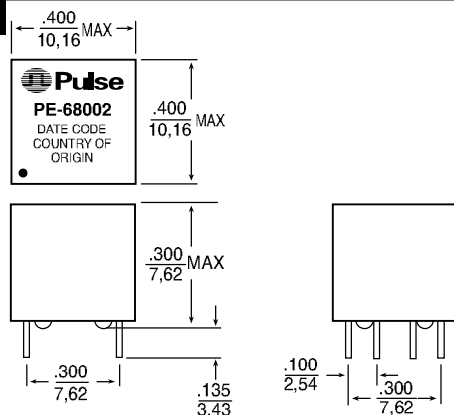

Dimensions: $\frac{\text{Inches}}{\text{mm}}$
Unless otherwise specified,
all tolerances are $\pm \frac{.010}{0,25}$

PE-68002

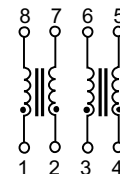

Weight 1.4 grams
Tube50/tube

THROUGH HOLE COMMON MODE CHOKES

Suited for LAN and Telecom Applications



Mechanicals

Schematics

B2005

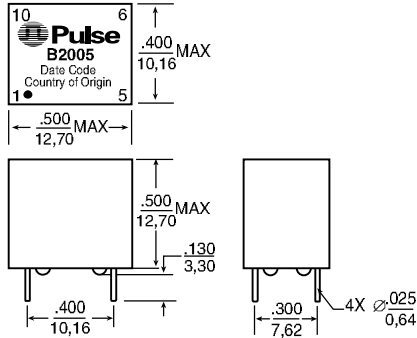

Dimensions: $\frac{\text{Inches}}{\text{mm}}$
Unless otherwise specified,
all tolerances are $\pm \frac{.005}{0,13}$

Weight 3.7 grams
Tube40/tube



23Z87

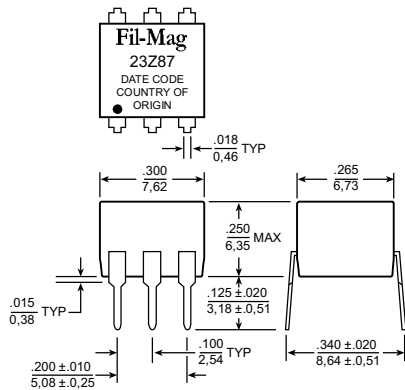

Dimensions: $\frac{\text{Inches}}{\text{mm}}$
Unless otherwise specified,
all tolerances are $\pm \frac{.005}{0,13}$

Weight 0.7 grams
Tube76/tube

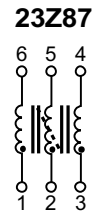

23Z104

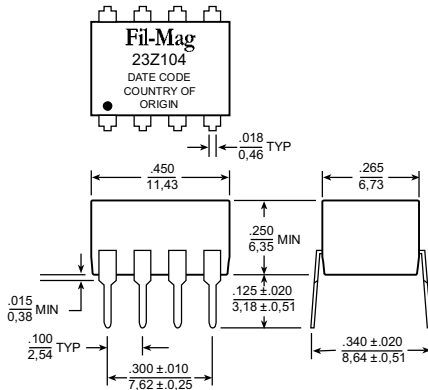

Dimensions: $\frac{\text{Inches}}{\text{mm}}$
Unless otherwise specified,
all tolerances are $\pm \frac{.005}{0,13}$

Weight 1.0 grams
Tube50/tube

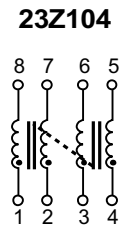

23Z106

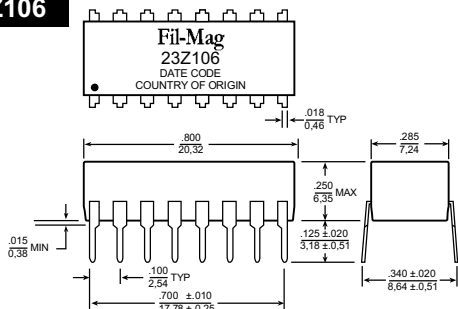

Dimensions: $\frac{\text{Inches}}{\text{mm}}$
Unless otherwise specified,
all tolerances are $\pm \frac{.005}{0,13}$

Weight 1.9 grams
Tube28/tube

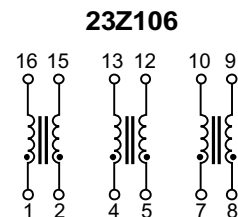

THROUGH HOLE COMMON MODE CHOKES

Suited for LAN and Telecom Applications



Mechanical

J0010D11 - Filtered Connector

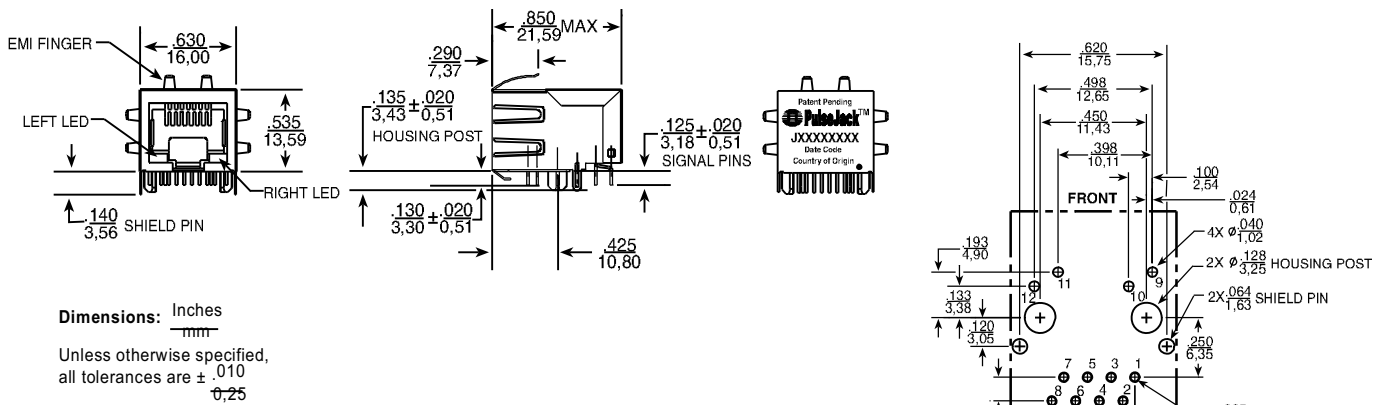

Common Mode Test Circuit for Surface Mount and Through Hole

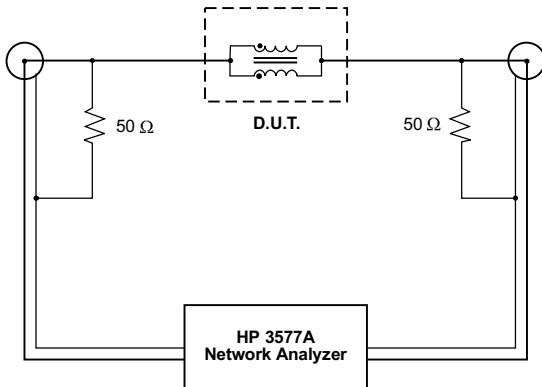

Test Notes:

1. Network analyzer calibrated to compensate for 50 Ω resistors.
2. All windings on a core are connected in parallel for the test.
3. For multi-core chokes, test data is for one core only. The windings on the other core(s) are left unconnected (i.e. open).

For More Information :

UNITED STATES (Worldwide)	UNITED KINGDOM (Northern Europe)	FRANCE (Southern Europe)	SINGAPORE (Southern Asia)	TAIWAN, R.O.C. (Northern Asia)	HONG KONG (China/Hong Kong)	DISTRIBUTOR
12220 World Trade Drive San Diego, CA 92128 U.S.A. http://www.pulseeng.com TEL: 858 674 8100 FAX: 858 674 8262	3 Huxley Road Surrey Research Park Guildford, Surrey GU2 5RE United Kingdom TEL: 44 1483 401700 FAX: 44 1483 401701	Zone Industrielle F-39270 Orgelet France TEL: 33 3 84 35 04 04 FAX: 33 3 84 25 46 41	150 Kampong Ampat #07-01/02 KA Centre Singapore 368324 TEL: 65 6287 8998 FAX: 65 6280 0080	3F-4, No. 81, Sec. 1 HsinTai Wu Road Hsi-Chih, Taipei Hsien Taiwan, R.O.C. Tel: 886 2 2698 0228 FAX: 886 2 2698 0948	9/F, Phase 2, Tai Sang Shatin Warehouse Centre 6 Wong Chuk Yeung Street Fotan Shatin, Hong Kong TEL: 852 2788 6588 FAX: 852 2776 1055	

Performance warranty of products offered on this data sheet is limited to the parameters specified. Data is subject to change without notice. Other brand and product names mentioned herein may be trademarks or registered trademarks of their respective owners.

© Copyright, 2004. Pulse Engineering, Inc. All rights reserved.