

Interference suppression film capacitors

MKP 336 2

MKP RADIAL POTTED TYPE

PITCH 10/15/22.5/27.5 mm

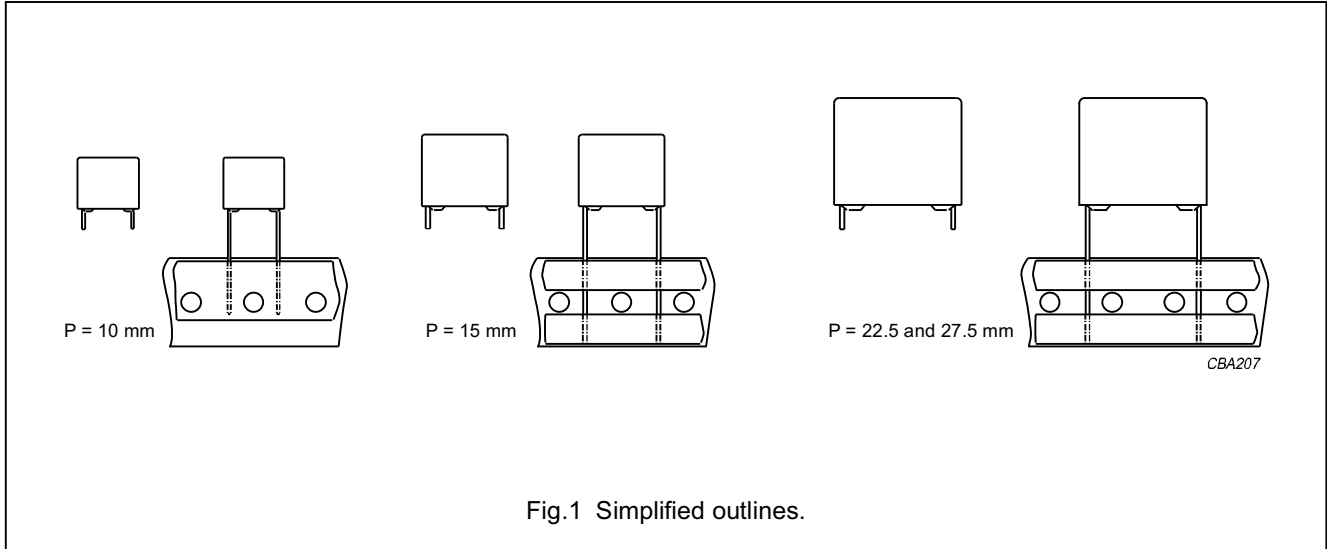

Fig.1 Simplified outlines.

FEATURES

- 10 to 27.5 mm lead pitch
- Supplied loose in box and taped on reel
- Consists of a low-inductive wound cell of metallized polypropylene film, potted in a flame-retardant case.

APPLICATIONS

- For X2 electromagnetic interference suppression
- Specially designed to meet the NEW REQUIREMENTS of the new "IEC 60384-14 2nd edition and EN 132400", requiring a 2.5 kV peak pulse voltage test and UL1414 and CSA-C22.2 No. 1 specifications.

DETAIL SPECIFICATION

For more detailed data and test requirements see "Type detail specification HQN-384-14/108".

QUICK REFERENCE DATA

DESCRIPTION	VALUE
Capacitance range (E12 series)	1 nF to 2.2 μF
Capacitance tolerance	±20%; ±10%; ±5%
Rated (AC) voltage, 50 to 60 Hz	275 V
Rated (DC) voltage	630 V
Climatic category	55/100/21/C
Rated temperature	100 °C
Maximum application temperature	100 °C
Reference specifications	IEC 60384-14 2 nd edition and EN 132400
Safety approvals:	
250 V	UL1414; CSA-C22.2 No. 1, note 1
275 V	UL1283; SEV; VDE; FI; N; D; S; IMQ; ÖVE, note 1; CCEE, note 2
Materials	qualified in accordance with UL94V-O
Safety class	X2













Notes

1. Approved.
2. Pending.

Interference suppression film capacitors

MKP 336 2

SAFETY APPROVALS

SAFETY APPROVALS (X2)		VOLTAGE	VALUE	FILE NUMBERS
	UL1414	250 V (AC)	1 nF to 1 µF	E 112471
	UL1283	275 V (AC)	1 nF to 2.2 µF	E 109565
	CSA-C22.2 No.1-M90	250 V (AC)	1 nF to 1 µF	LR 94054
	SEV (EN132400)	275 V (AC)	1 nF to 2.2 µF	96,770678
	VDE (EN132400)	275 V (AC)	1 nF to 2.2 µF	83618
	FI (EN132400)	275 V (AC)	1 nF to 2.2 µF	176515
	NEMKO (EN132400)	275 V (AC)	1 nF to 2.2 µF	P94101881
	DEMKO (EN132400)	275 V (AC)	1 nF to 2.2 µF	302811
	SEMKO (EN132400)	275 V (AC)	1 nF to 2.2 µF	9439096
	IMQ (EN132400)	275 V (AC)	1 nF to 2.2 µF	V 3732
	ÖVE (EN132400)	275 V (AC)	1 nF to 2.2 µF	E 260-000-00
	CCEE	275 V (AC)	1 nF to 2.2 µF	pending

Interference suppression film capacitors

MKP 336 2

COMPOSITION OF CATALOGUE NUMBER

TYPE AND PITCHES	
336 2 X2	10.0 mm
	15.0 mm
	22.5 mm
	27.5 mm

CAPACITANCE
(numerically)

MULTIPLIER (nF)	
0.1	2
1	3
10	4
100	5

Example:
104 = 10 × 10 = 100 nF

2222 | 336 | 2X | XX | X

TYPE	PACKAGING ⁽¹⁾	LEAD CONFIGURATION	C-TOL	PREFERRED TYPES
336 2 X2	loose in box	lead length 3.5 mm	±20%	0
		lead length 25.0 mm		6
				ON REQUEST
336 2 X2	loose in box	lead length 3.5 mm	±10%	2222 336 21...
		lead length 25.0 mm		2222 336 27...
	taped on reel	H = 18.5 mm; note 2	±20%	2222 336 23...
			±10%	2222 336 24...

Notes

1. For SPQ refer to this handbook, chapter "Packaging information"; taped on reel pitch = 27.5 mm is not available.
2. H = in-tape height; for detailed specifications refer to this handbook, chapter "Packaging information".

Interference suppression film capacitors

MKP 336 2

MKP 336 2 GENERAL DATA

PITCH 10/15 mm

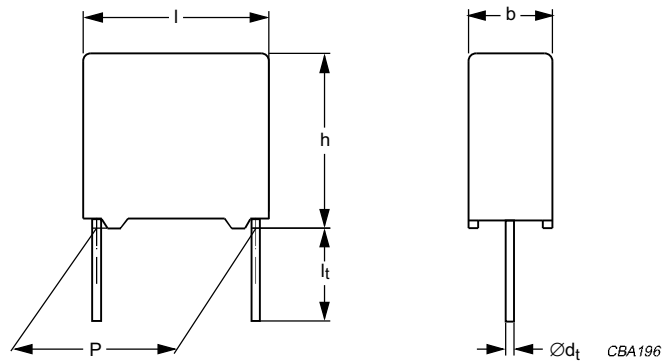

Fig.3 Outline.

Specific reference data for the 275 V AC (X2) capacitors

DESCRIPTION	VALUE	
	at 10 kHz	at 100 kHz
Tangent of loss angle: C ≤ 100 nF 100 nF < C ≤ 220 nF	≤10 × 10 ⁻⁴ ≤20 × 10 ⁻⁴	≤50 × 10 ⁻⁴ ≤100 × 10 ⁻⁴
Rated voltage pulse slope (dU/dt) _R at 385 V (DC)	100 V/μs	
R between leads, for C ≤ 0.33 μF at 100 V; 1 minute	>15000 MΩ	
R between leads and case; 100 V; 1 minute	>30000 MΩ	
Withstanding (DC) voltage (cut off current 10 mA); rise time 100 V/s	2200 V; 1 minute	
Withstanding (AC) voltage between leads and case	2050 V; 1 minute	

Interference suppression film capacitors

MKP 336 2

 $U_{Rac} = 275 \text{ V (X2)}$; $U_{Rdc} = 630 \text{ V}$

C (μF)	DIMENSIONS $b \times h \times l$ (mm)	MASS (g)	CATALOGUE NUMBER	
			LOOSE IN BOX	
			$l_t = 3.5 +1/-0.5 \text{ mm}^{(1)}$	$l_t = 25.0 \pm 2.0 \text{ mm}$
			C-tol = $\pm 20\%$	
			catalogue number ⁽²⁾	last 5 digits ⁽²⁾
Pitch = $10.0 \pm 0.4 \text{ mm}$; $d_t = 0.60 \pm 0.06 \text{ mm}$				
0.001	4.0 × 10.0 × 12.5	0.6	2222 336 20102	.. 26102
0.0015			2222 336 20152	.. 26152
0.0022			2222 336 20222	.. 26222
0.0033	5.0 × 11.0 × 12.5	0.9	2222 336 20332	.. 26332
0.0047			2222 336 20472	.. 26472
0.0068			2222 336 20682	.. 26682
0.01			2222 336 20103	.. 26103
0.015			2222 336 20153	.. 26153
0.022			2222 336 20223	.. 26223
0.033	6.0 × 12.0 × 12.5	1.0	2222 336 20333	.. 26333
Pitch = $15.0 \pm 0.4 \text{ mm}$; $d_t = 0.80 \pm 0.08 \text{ mm}$				
0.01	5.0 × 11.0 × 17.5	1.2	2222 336 29001	.. 29097
0.015			2222 336 29011	.. 29071
0.022			2222 336 29021	.. 29076
0.033			2222 336 29031	.. 29082
0.047			2222 336 20473	.. 26473
0.068			2222 336 20683	.. 26683
0.1	6.0 × 12.0 × 17.5	1.4	2222 336 20104	.. 26104
0.15	8.5 × 15.0 × 17.5	2.6	2222 336 20154	.. 26154
0.22	10.0 × 16.5 × 17.5	3.1	2222 336 20224	.. 26224

Notes

1. $l_t = 3.5 \pm 0.3 \text{ mm}$ for pitch = 15 mm.
2. The shading indicates preferred types.

Interference suppression film capacitors

MKP 336 2

MKP 336 2 GENERAL DATA

PITCH 22.5/27.5 mm

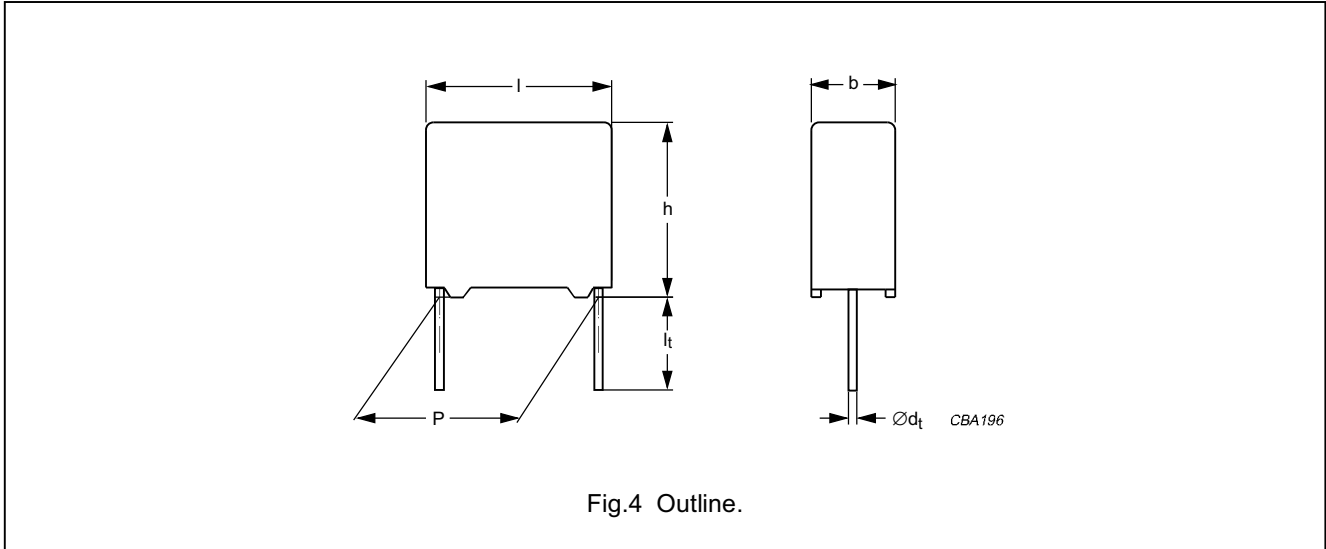

Specific reference data for the 275 V AC (X2) capacitors

DESCRIPTION	VALUE	
	at 10 kHz	at 100 kHz
Tangent of loss angle: 150 nF < C ≤ 470 nF C > 470 nF	≤20 × 10 ⁻⁴ ≤70 × 10 ⁻⁴	≤100 × 10 ⁻⁴ -
Rated voltage pulse slope (dU/dt) _R at 385 V (DC)	100 V/μs	
R between leads, for C ≤ 0.33 μF at 100 V; 1 minute	>15000 MΩ	
RC between leads, for C > 0.33 μF at 100 V; 1 minute	>5000 s	
R between leads and case; 100 V; 1 minute	>30000 MΩ	
Withstanding (DC) voltage (cut off current 10 mA); rise time 100 V/s: C ≤ 1 μF C > 1 μF	2200 V; 1 minute 1800 V; 1 minute	
Withstanding (AC) voltage between leads and case	2050 V; 1 minute	

Interference suppression film capacitors

MKP 336 2

 $U_{Rac} = 275 \text{ V (X2)}$; $U_{Rdc} = 630 \text{ V}$

C (μF)	DIMENSIONS $b \times h \times l$ (mm)	MASS (g)	CATALOGUE NUMBER	
			LOOSE IN BOX	
			$l_t = 3.5 \pm 0.3 \text{ mm}$	$l_t = 25.0 \pm 2.0 \text{ mm}$
			C-tol = $\pm 20\%$	
			catalogue number ⁽¹⁾	last 5 digits ⁽¹⁾
Pitch = $22.5 \pm 0.4 \text{ mm}$; $d_t = 0.80 \pm 0.08 \text{ mm}$				
0.15	$6.0 \times 15.5 \times 26.0$	2.9	2222 336 29041	.. 29087
0.22	$7.0 \times 16.5 \times 26.0$	3.2	2222 336 29051	.. 29093
0.33	$8.5 \times 18.0 \times 26.0$	4.4	2222 336 20334	.. 26334
0.47	$10.0 \times 19.5 \times 26.0$	5.5	2222 336 20474	.. 26474
Pitch = $27.5 \pm 0.4 \text{ mm}$; $d_t = 0.80 \pm 0.08 \text{ mm}$				
0.47	$9.0 \times 19.0 \times 31.0$	5.5	2222 336 29055	.. 29095
0.68	$11.0 \times 21.0 \times 31.0$	7.8	2222 336 20684	.. 26684
1	$13.0 \times 23.0 \times 31.0$	10.4	2222 336 20105	.. 26105
1.5	$18.0 \times 28.0 \times 31.0$	17.2	2222 336 20155	.. 26155
2.2	$21.0 \times 31.0 \times 31.0$	20.4	2222 336 20225	.. 26225

Note

1. The shading indicates preferred types.

Interference suppression film capacitors

MKP 336 2

CONSTRUCTION**Description**

- Low-inductive wound cell of metallized polypropylene (PP) film, potted with epoxy resin in a flame-retardant polypropylene case
- Radial leads, solder-coated:
 - Copper clad steel wire for pitch = 10 and 15 mm
 - Copper wire for pitch = 22.5 and 27.5 mm
- Small stand-off pips allow removal of solder flux etc. during cleaning of the printed-circuit board.

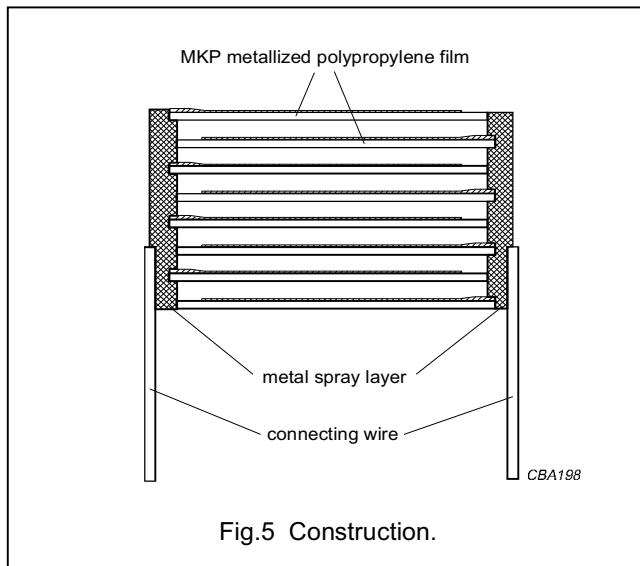
**Mounting****NORMAL USE**

The capacitors are designed for mounting on printed-circuit boards. The capacitors packed in bandoliers are designed for mounting on printed-circuit boards by means of automatic insertion machines. For detailed tape specifications refer to this handbook, chapter "Packaging information".

SPECIFIC METHOD OF MOUNTING TO WITHSTAND VIBRATION AND SHOCK

In order to withstand vibration and shock tests, it must be ensured that the stand-off pips are in good contact with the printed-circuit board:

- For pitches ≤ 15 mm capacitors shall be mechanically fixed by the leads.
- For larger pitches the capacitors shall be mounted in the same way and the body clamped.

SPACE REQUIREMENTS ON PRINTED-CIRCUIT BOARD

The maximum length and width of film capacitors is shown in Fig.6:

- Eccentricity as in Fig.6. The maximum eccentricity is smaller than or equal to the lead diameter of the product concerned.
- Product height with seating plane as given by "IEC 60717" as reference: $h_{\max} \leq h + 0.3$ mm.

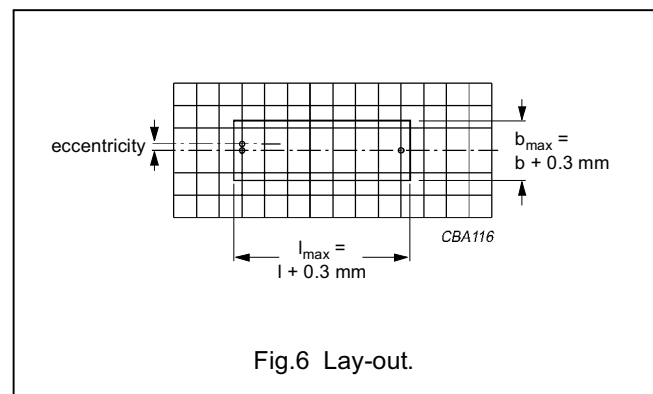
**Storage temperature**

- Storage temperature: $T_{\text{stg}} = -25$ to $+40$ °C with RH maximum 80% without condensation.

RATINGS AND CHARACTERISTICS REFERENCE CONDITIONS

Unless otherwise specified, all electrical values apply to an ambient temperature of 23 ± 1 °C, an atmospheric pressure of 86 to 106 kPa and a relative humidity of $50 \pm 2\%$.

For reference testing, a conditioning period shall be applied over 96 ± 4 hours by heating the products in a circulating air oven at the rated temperature and a relative humidity not exceeding 20%.

Interference suppression film capacitors

MKP 336 2

CHARACTERISTICS

Capacitance

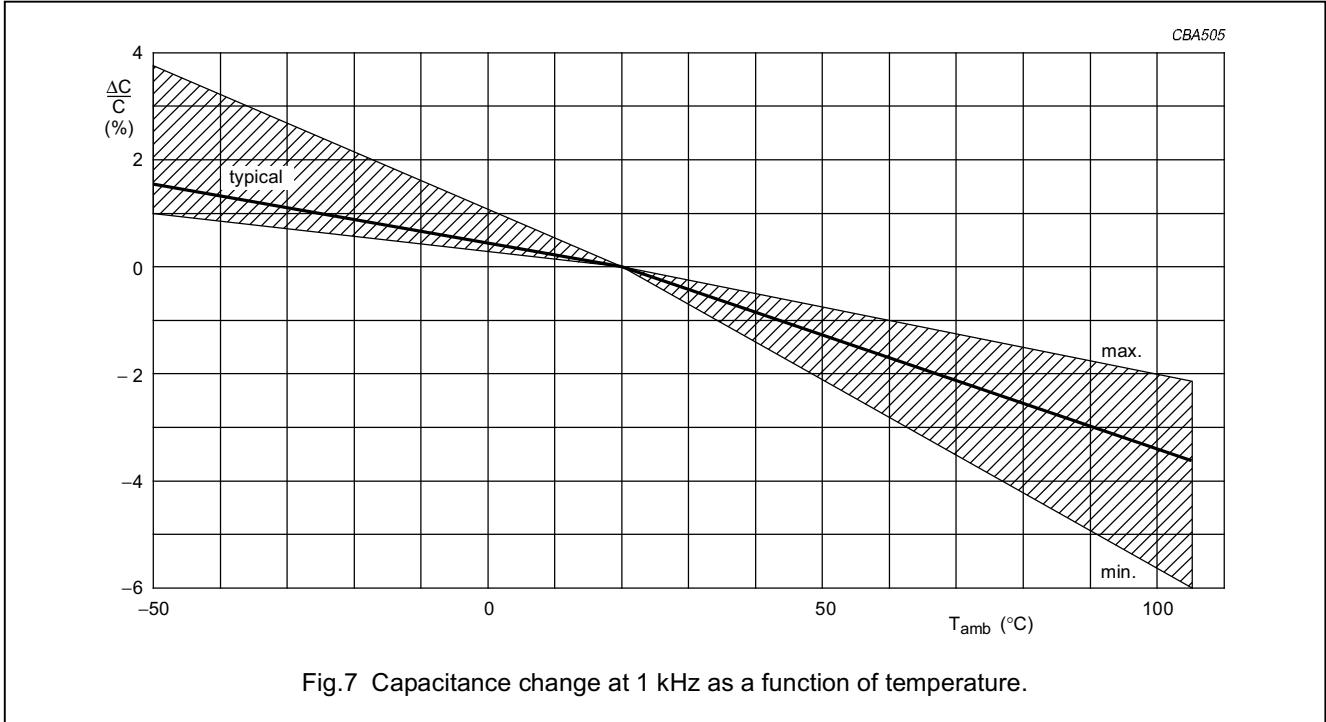

Tangent of loss angle

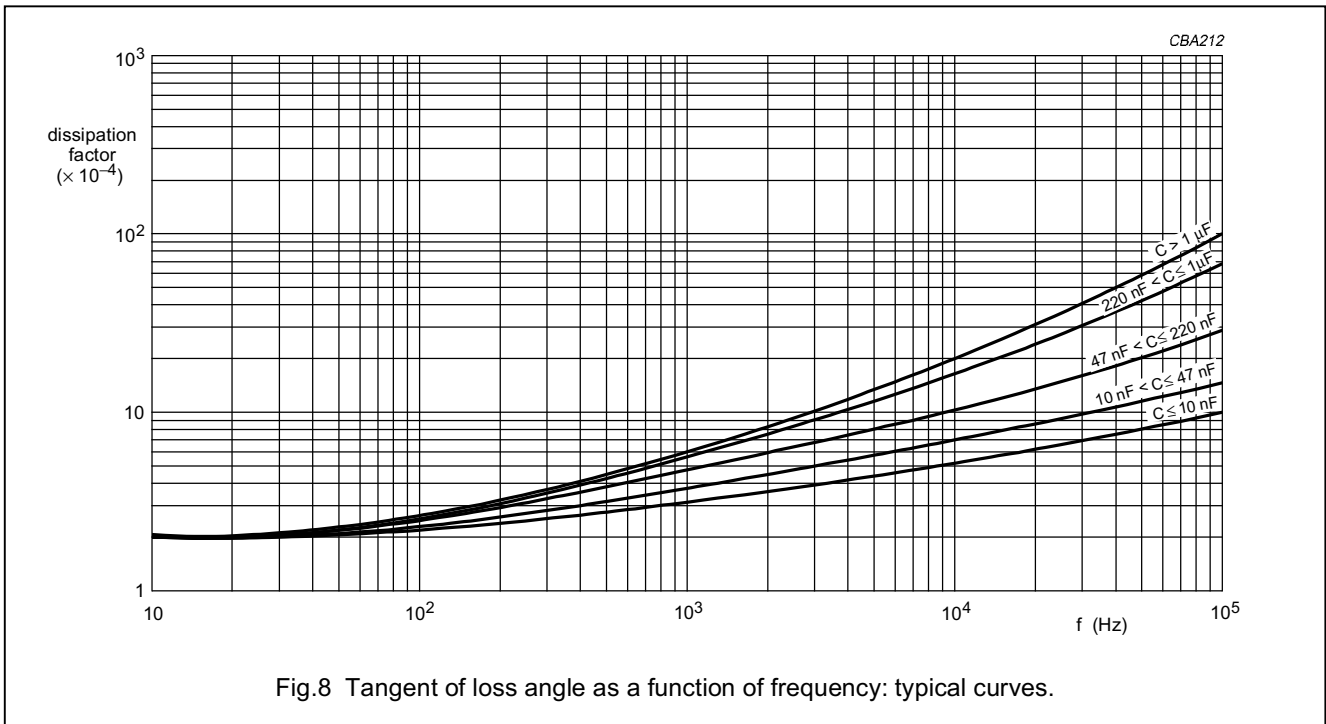

Interference suppression film capacitors

MKP 336 2

Impedance

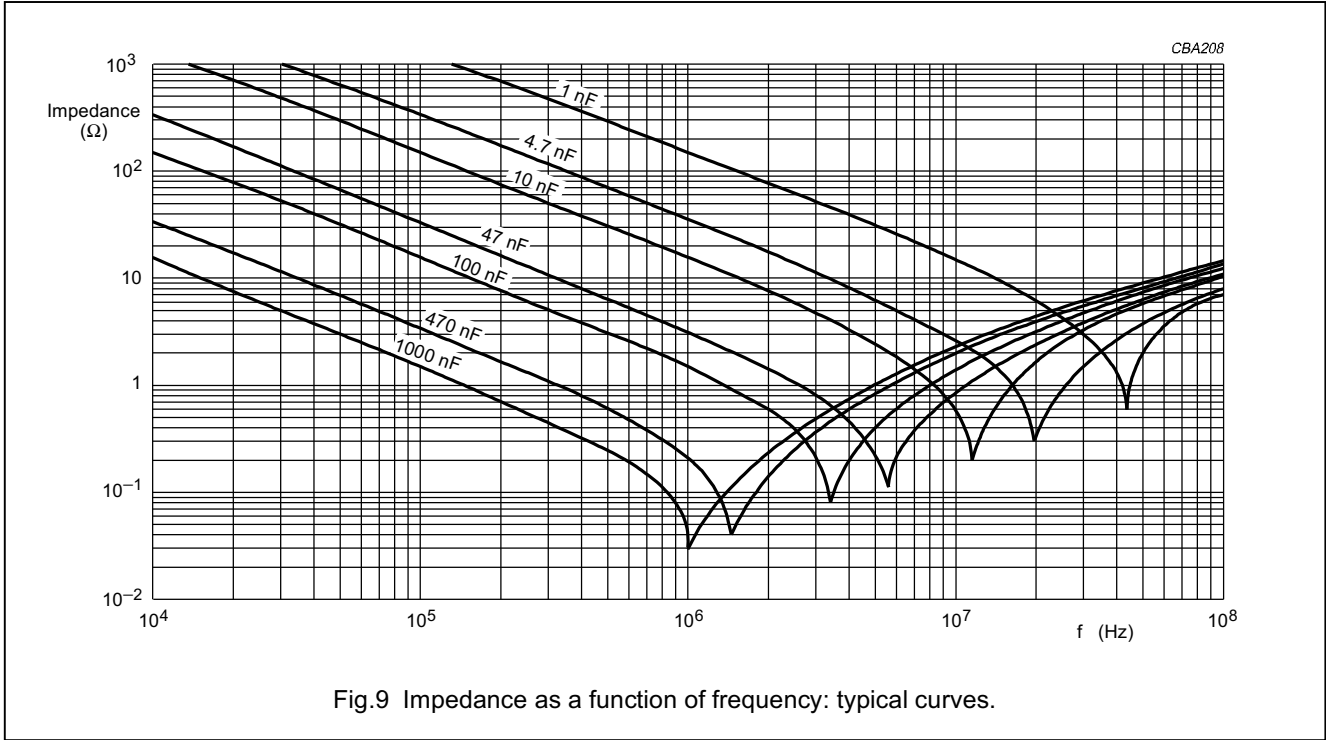

Fig.9 Impedance as a function of frequency: typical curves.

Resonant frequency

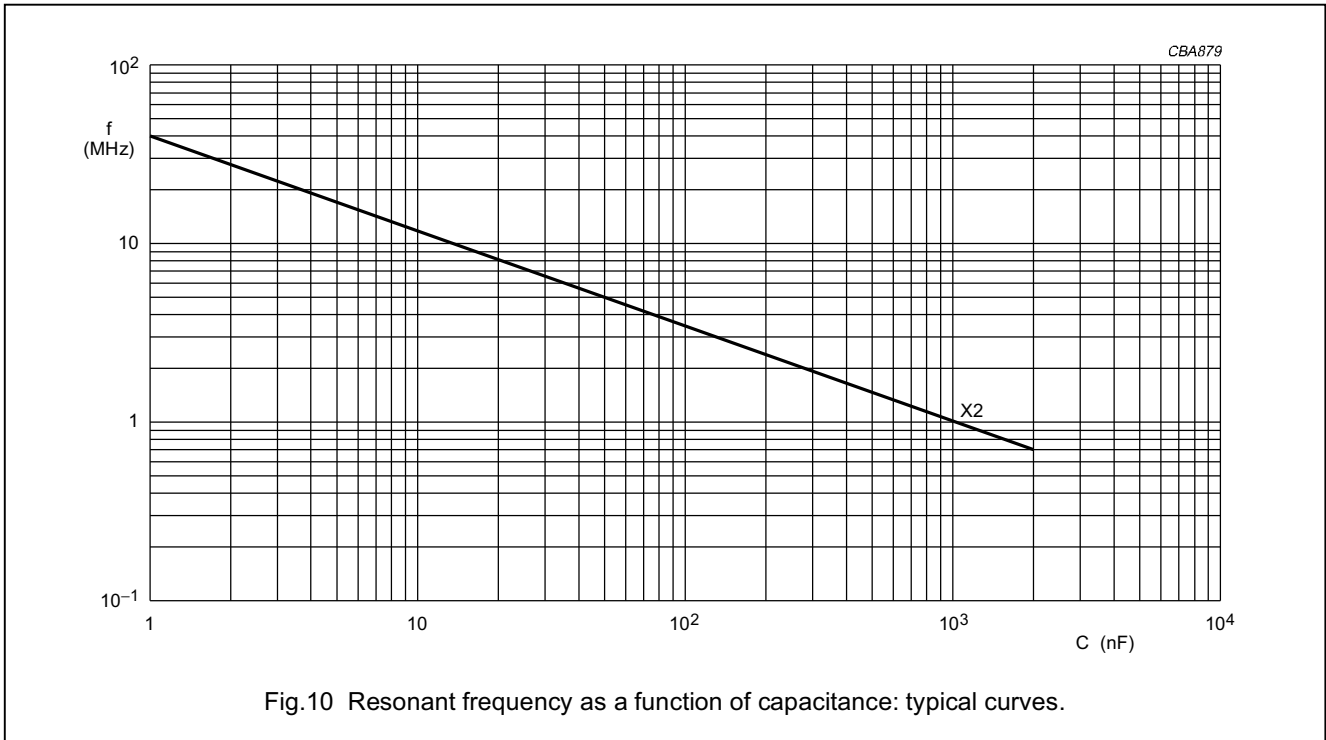
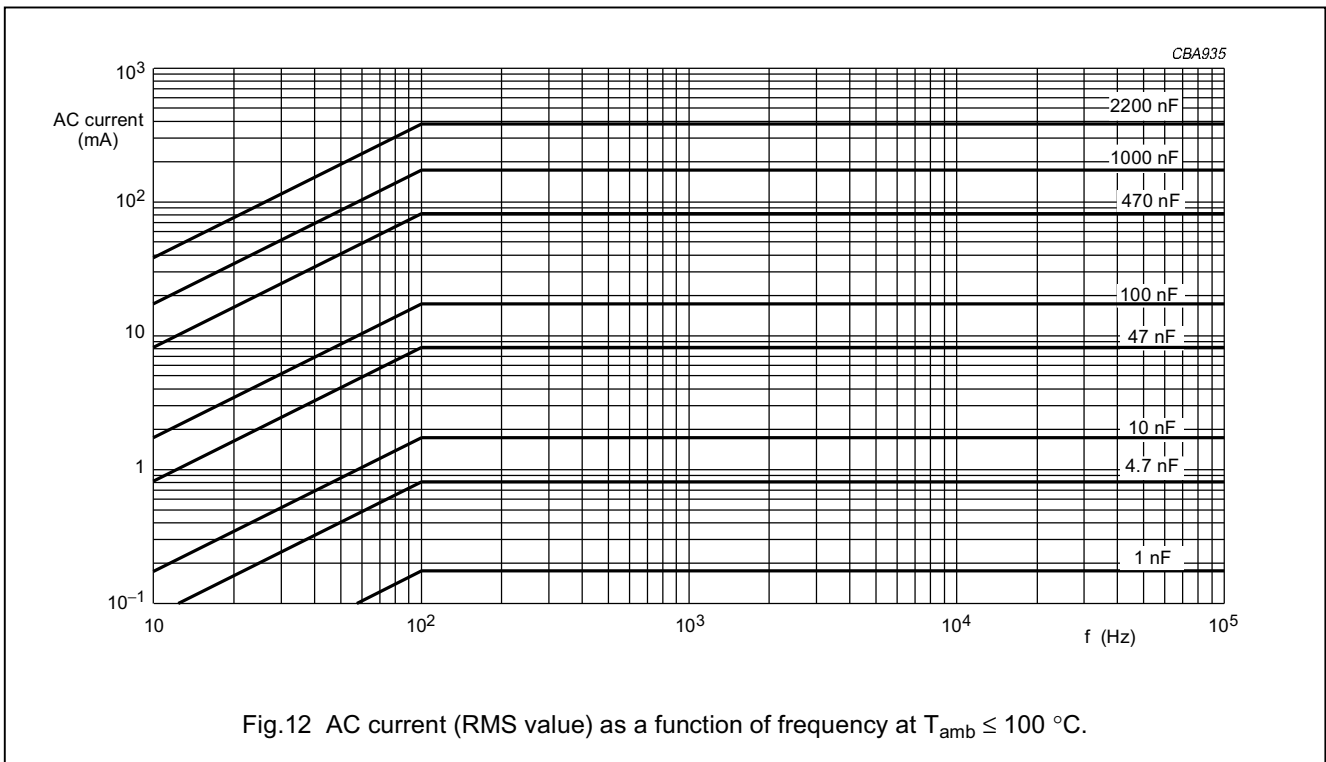
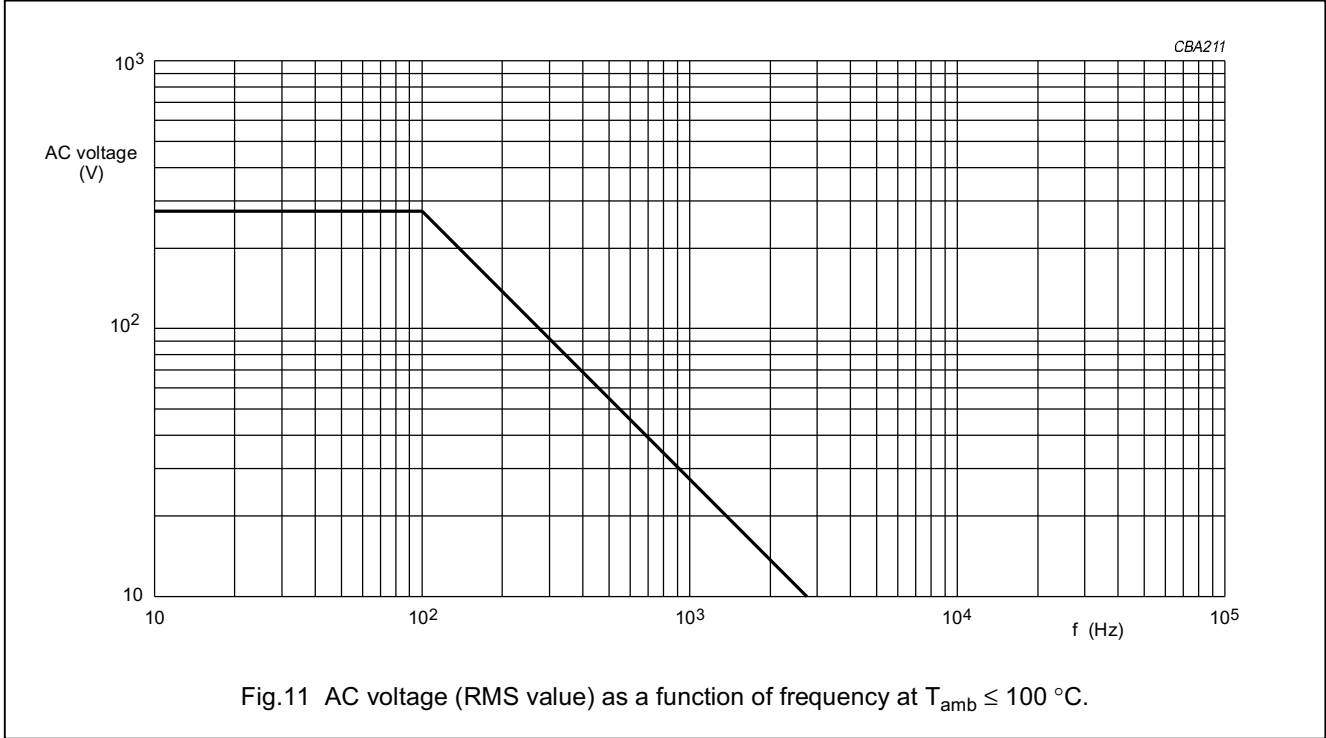

Fig.10 Resonant frequency as a function of capacitance: typical curves.

Interference suppression film capacitors

MKP 336 2

Maximum RMS voltage and AC current (sinewave) as a function of frequency for $T_{amb} \leq 100\text{ }^{\circ}\text{C}$



Interference suppression film capacitors

MKP 336 2

Insulation resistance

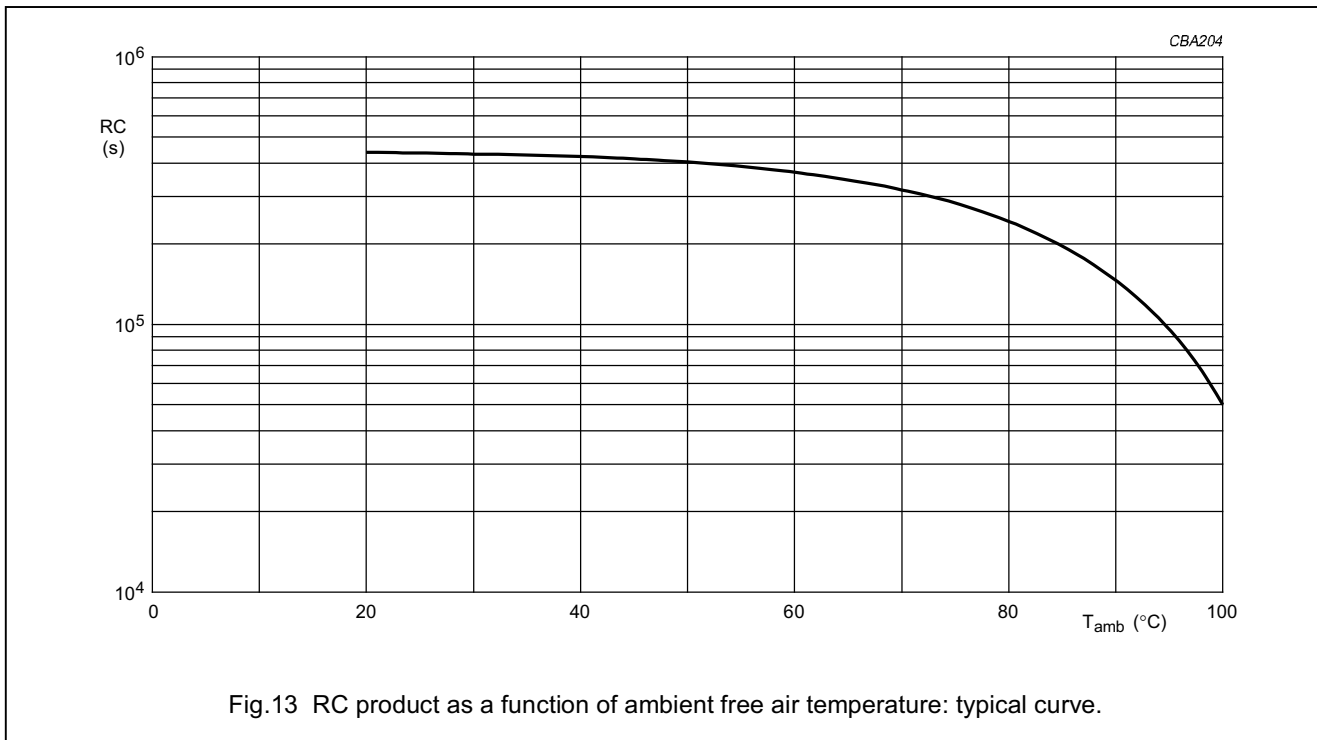

APPLICATION NOTES

- For X2 electromagnetic interference suppression in across the line applications (50 to 60 Hz) with a maximum mains voltage of 275 V (AC).
- These capacitors are not intended for continuous pulse applications. For these situations, capacitors of the AC and pulse program must be used, such as: 2222 375; 2222 383 or 2222 479
- The maximum ambient temperature must not exceed 100 °C.
- Rated voltage pulse slope:
 - If the pulse voltage is lower than the rated voltage, the values of the specific reference data can be multiplied by 385 V (DC) and divided by the applied voltage.

Interference suppression film capacitors

MKP 336 2

MARKING

Product marking

The capacitors are marked by laser print; on the top for pitch ≥ 22.5 mm (see Fig.16), on the top and one side for pitch = 15 mm (see Fig.15) or on one side for pitch = 10 mm (see Fig.14) with the following information:

1. Rated capacitance code in accordance with "IEC 60062"
2. Tolerance on rated capacitance; M = $\pm 20\%$; K = $\pm 10\%$; J = $\pm 5\%$
3. Rated (AC) voltage (275 V)
4. Sub-class (e.g. X2)
5. Manufacturer's type designation (e.g. 336 2)
6. Code for dielectric material (MKP) for pitch ≥ 15 mm
7. Manufacturer
8. Year and week of manufacture (e.g. 9701) for pitch ≥ 15 mm
9. Safety approvals: products will be marked with approvals depending on the available marking space per product. Although all approvals remain valid as indicated in the reference data.

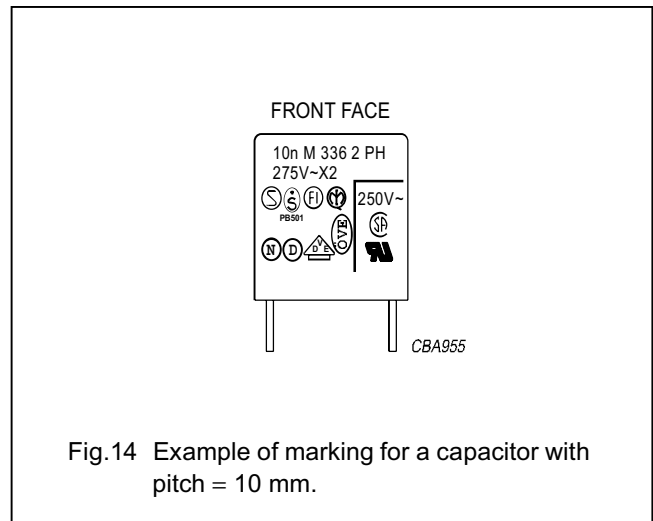

Fig.14 Example of marking for a capacitor with pitch = 10 mm.

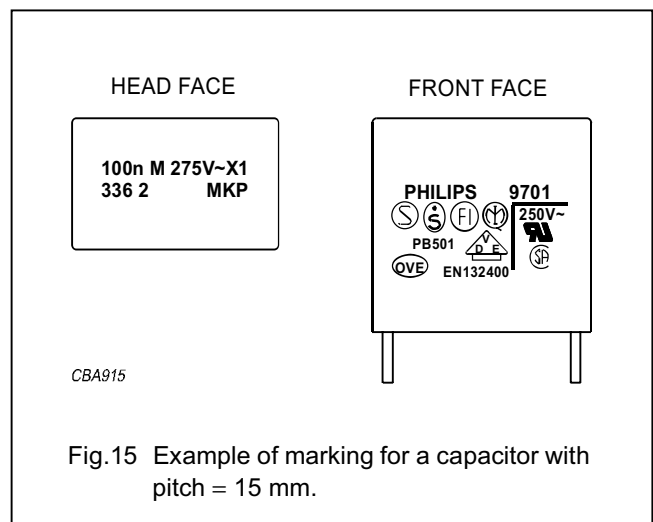

Fig.15 Example of marking for a capacitor with pitch = 15 mm.

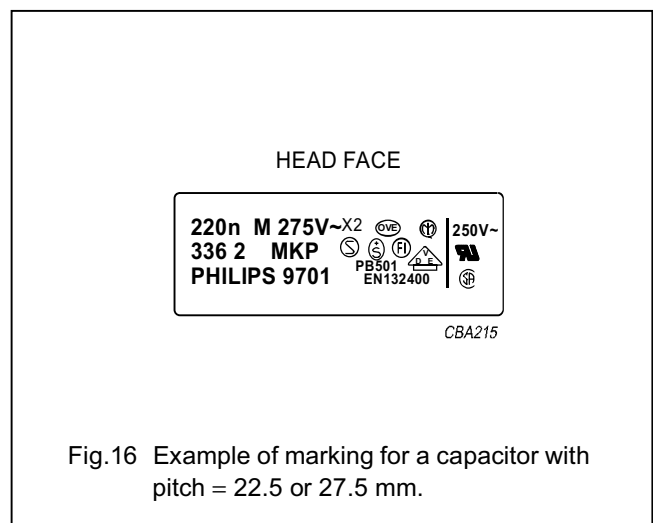

Fig.16 Example of marking for a capacitor with pitch = 22.5 or 27.5 mm.

Interference suppression film capacitors

MKP 336 2

Package marking

The package containing the capacitors is marked as shown Fig.17.

Please note:
 In due time BC COMPONENTS
 will replace PHILIPS COMPONENTS

LINE	MARKING EXPLANATION
1.	Manufacturer's name
2.	Country of origin
3.	Sub-family
4.	Type description and sub class
5.	Capacitance value, tolerance, voltage and climatic category ("IEC 60068-1")
6.	Safety approvals
7.	Preference origin code: A Country of origin in code: 170 (Belgium) Responsible production centre: HQ Work order: WO Wage number of final inspection (only for capacitors with pitch = 10 mm)
8.	Product type description
9.	Quantity and production period, year and week code
10.	Product code (12NC)

CCA329

Fig.17 Barcode label.

Interference suppression film capacitors

MKP 336 2

QUICK REFERENCE TEST REQUIREMENTS (see note 1)

TEST	PROCEDURE (quick reference)	REQUIREMENTS
Robustness of leads		
Tensile strength: "IEC 60068-2-21"	load 10 N; 10 s	no visible damage legible marking $ \Delta C/C \leq 5\%$ $\Delta \tan \delta \leq 100 \times 10^{-4}$ ($C \leq 100$ nF); note 2 $\Delta \tan \delta \leq 200 \times 10^{-4}$ (100 nF < $C \leq 470$ nF); note 2 $\Delta \tan \delta \leq 70 \times 10^{-4}$ ($C > 470$ nF); note 2
Bending: "IEC 60068-2-21"	load 5 N; $4 \times 90^\circ$	
Resistance to soldering heat: "IEC 60068-2-20"	solder bath: 260 °C; 10 s	
Component solvent resistance	isopropyl alcohol; 23 °C; 5 minutes	
Robustness of component		
Rapid change of temperature: "IEC 60068-2-14"	5 cycles 1 cycle = 30 minutes at -55 °C and 30 minutes at 100 °C	$ \Delta C/C \leq 5\%$ $\Delta \tan \delta \leq 100 \times 10^{-4}$ ($C \leq 100$ nF); note 2 $\Delta \tan \delta \leq 200 \times 10^{-4}$ (100 nF < $C \leq 470$ nF); note 2 $\Delta \tan \delta \leq 70 \times 10^{-4}$ ($C > 470$ nF); note 2
Vibration: "IEC 60068-2-6"	10 to 55 Hz; amplitude 0.75 mm; 6 hours	
Shock: "IEC 60068-2-27"	half sinewave; 490 m/s ² ; 11 ms	
Climatic sequence		
Dry heat: "IEC 60068-2-2"	16 hours; 100 °C	$ \Delta C/C \leq 5\%$ $\Delta \tan \delta \leq 100 \times 10^{-4}$ ($C \leq 100$ nF); note 2 $\Delta \tan \delta \leq 200 \times 10^{-4}$ (100 nF < $C \leq 470$ nF); note 2 $\Delta \tan \delta \leq 70 \times 10^{-4}$ ($C > 470$ nF); note 2 $R_{ins} \geq 50\%$ of specified value
Damp heat, cyclic, test Db, first cycle: "IEC 60068-2-30"		
Cold: "IEC 60068-2-1"	2 hours; -55 °C	
Damp heat, cyclic, test Db, remaining cycles: "IEC 60068-2-30"		
Voltage proof: "IEC 60384-14"	$V_p = 1200$ V (DC); 1 minute	
Other applicable tests		
Damp heat, steady state: "IEC 60068-2-3"	21 days; 40 °C; 90 to 95% RH no load $V_p = 1200$ V (DC); 1 minute	$ \Delta C/C \leq 5\%$ $\Delta \tan \delta \leq 70 \times 10^{-4}$ $R_{ins} \geq 50\%$ of specified value
Endurance (AC): "IEC 60384-14"	3×2.5 kV pulse voltage 1000 hours; $1.25 \times U_{Rac}$ at 100 °C; once per hour; 0.1 s; 1000 V (RMS) via resistor of 47 Ω ; $V_p = 1200$ V (DC); 1 minute	
		$ \Delta C/C \leq 10\%$ $\Delta \tan \delta \leq 100 \times 10^{-4}$ ($C \leq 100$ nF); note 2 $\Delta \tan \delta \leq 200 \times 10^{-4}$ (100 nF < $C \leq 470$ nF); note 2 $\Delta \tan \delta \leq 70 \times 10^{-4}$ ($C > 470$ nF); note 2 $R_{ins} \geq 50\%$ of specified value

Interference suppression film capacitors

MKP 336 2

TEST	PROCEDURE (quick reference)	REQUIREMENTS
Charge and discharge: "IEC 60384-14"	10000 cycles; 5 ms; $1.5 \times dV/dt$	$ \Delta C/C \leq 10\%$ $\Delta \tan \delta \leq 100 \times 10^{-4}$ ($C \leq 100$ nF); note 2 $\Delta \tan \delta \leq 200 \times 10^{-4}$ (100 nF < $C \leq 470$ nF); note 2 $\Delta \tan \delta \leq 70 \times 10^{-4}$ ($C > 470$ nF); note 2 $R_{ins} \geq 50\%$ of specified value
Passive flammability: "IEC 60384-14"	class C	no burning
Active flammability: "IEC 60384-14"	20×2.5 kV discharge	no burning
Heat storage: "IEC 60384-14"	1000 hours; 100 °C	$ \Delta C/C \leq 5\%$ $\Delta \tan \delta \leq 100 \times 10^{-4}$ ($C \leq 100$ nF); note 2 $\Delta \tan \delta \leq 200 \times 10^{-4}$ (100 nF < $C \leq 470$ nF); note 2 $\Delta \tan \delta \leq 70 \times 10^{-4}$ ($C > 470$ nF); note 2
Resistance to soldering heat with preheating: "IEC 60384-14"	preheating: 100 °C; solder bath: 260 °C; 10 s	$ \Delta C/C \leq 5\%$ $\Delta \tan \delta \leq 100 \times 10^{-4}$ ($C \leq 100$ nF); note 2 $\Delta \tan \delta \leq 200 \times 10^{-4}$ (100 nF < $C \leq 470$ nF); note 2 $\Delta \tan \delta \leq 70 \times 10^{-4}$ ($C > 470$ nF); note 2
Active flammability test	voltage proof up to 4 kV (DC) or until breakdown (100 V/s, current limited 2 mA) failed capacitors connected to a 250 V (AC) power supply during 5 minutes	no burning

Notes

1. For detailed information: see "Type detail specification HQN-384-14/108".
2. Measuring frequency 100 kHz for $C \leq 470$ nF and 10 kHz for $C > 470$ nF.