

# NAIS

## LOW PROFILE 2 FORM C RELAY

# TQ-RELAYS

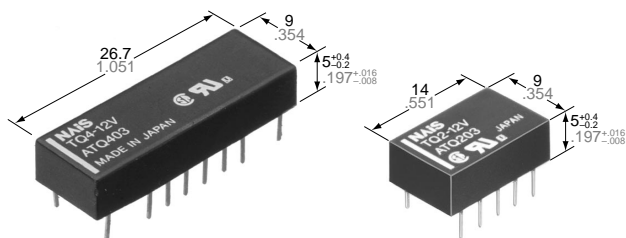

mm inch

## FEATURES

- **High sensitivity:**  
2 Form C: 140 mW power consumption (single side stable type)  
4 Form C: 280 mW power consumption (single side stable type)
- **Surge voltage withstand: 1500 V FCC Part 68**
- **Sealed construction allows automatic washing**
- **Self-clinching terminal also available**
- **M.B.B. contact types available**

## SPECIFICATIONS

### Contact

		Standard (B.B.M) type		M.B.B.type
		2 Form C	4 Form C	2 Form D
Arrangement		2 Form C	4 Form C	2 Form D
Initial contact resistance, max. (By voltage drop 6 V DC 1A)		50 mΩ		
Contact material		Gold-clad silver		
Rating	Nominal switching capacity (resistive load)	1 A 30 V DC 0.5 A 125 V AC		1 A 30 V DC
	Max. switching power (resistive load)	30 W, 62.5 V A		30 W
	Max. switching voltage	110 V DC, 125 V AC		110 V DC
	Max. switching current	1 A		
	Min. switching capacity *1	10 μA 10 mV DC		
Nominal operating power	Single side stable	140 mW (3 to 12 V DC) 200 mW (24 V DC) 300 mW (48 V DC)	280 mW (3 to 24 V DC) 400 mW (48 V DC)	200 mW
	1 coil latching	100 mW (3 to 12 V DC) 150 mW (24 V DC)	200 mW	—
	2 coil latching	200 mW (3 to 12 V DC) 300 mW (24 V DC)	400 mW	—
Expected life (min. operations)	Mechanical (at 180 cpm)	10 <sup>8</sup>		10 <sup>7</sup>
	Electrical (at 20 cpm) (1 A 30 V DC resistive)	1 A 30 V DC resistive	2×10 <sup>5</sup>	
		0.5 A 125 V AC resistive	10 <sup>5</sup>	

### Note:

\*1 This value can change due to the switching frequency, environmental conditions, and desired reliability level, therefore it is recommended to check this with the actual load.

### Remarks

- \* Specifications will vary with foreign standards certification ratings.
- \*1 Measurement at same location as "Initial breakdown voltage" section.
- \*2 By resistive method, nominal voltage applied to the coil; contact carrying current: 1 A.
- \*3 Nominal voltage applied to the coil, excluding contact bounce time.
- \*4 Nominal voltage applied to the coil, excluding contact bounce time without diode.
- \*5 Half-wave pulse of sine wave: 11 ms; detection time: 10 μs.
- \*6 Half-wave pulse of sine wave: 6 ms.
- \*7 Detection time: 10 μs.

### Characteristics

		Standard (B.B.M) type		M.B.B.type
		2 Form C	4 Form C	2 Form D
Initial insulation resistance*1		Min. 1,000 MΩ (at 500 V DC)		
Initial breakdown voltage	Between open contacts	750 Vrms for 1 min. (Detection current: 10 mA)	300 Vrms for 1 min. (Detection current: 10 mA)	
	Between contact and coil	1,000 Vrms for 1 min. (Detection current: 10 mA)		
	Between contact sets	1,000 Vrms for 1 min. (Detection current: 10 mA)		
FCC surge voltage between open contacts		1,500 V		
Operate time [Set time]*3 (at 20°C)		Max. 3 ms (Approx. 2 ms) [Max. 3 ms (Approx. 2 ms)]		
Release time [Reset time]*4 (at 20°C)		Max. 3 ms (Approx. 1 ms) [Max. 3 ms (Approx. 2 ms)]		
M.B.B. time*8		— Min. 10 μs.		
Temperature rise*2 (at 20°C)		Max. 50°C		
Shock resistance	Functional*5	Min. 490 m/s <sup>2</sup> {50G}		
	Destructive*6	Min. 980 m/s <sup>2</sup> {100G}		
Vibration resistance	Functional*7	176.4 m/s <sup>2</sup> {18G}, 10 to 55 Hz at double amplitude of 3 mm		
	Destructive	294 m/s <sup>2</sup> {30G}, 10 to 55 Hz at double amplitude of 5 mm		
Conditions for operation, transport and storage*9 (Not freezing and condensing at low temperature)	Ambient temperature	-40°C to +70°C -40°F to +158°F	-40°C to +50°C -40°F to +122°F	
	Humidity	5 to 85% R.H.		
Unit weight	2 Form C:	Approx. 1.5 g .053 oz		
	4 Form C:	Approx. 3 g .106 oz. —		

\*8 M.B.B. time:

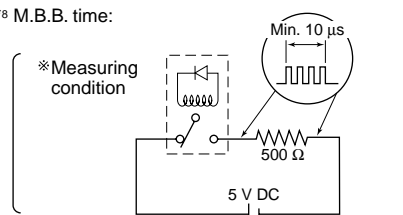

\*9 Refer to 4. Conditions for operation, transport and storage mentioned in Cautions for use (Page 178).

## ORDERING INFORMATION

EX. TQ 2 H — L2 — 2M — 3V

Contact arrangement	Terminal shape	Operating function	MBB function	Coil voltage (DC)
2: 2 Form C 4: 4 Form C	Nil: Standard PC board terminal H: Self-clinching terminal	Nil: Single side stable L: 1 coil latching L2: 2 coil latching	Nil: Standard (B.B.M.) type 2M: 2M.B.B. type	3, 4.5, 5, 6, 9, 12, 24, 48* V

\*48 V coil type: Single side stable only

Notes: 1. AgPd stationary contact types available for high resistance against contact sticking.

When ordering, please add suffix "-3" like TQ2-12V-3.

2. M.B.B. contact types are available only for TQ2 type.

## TYPES AND COIL DATA (at 20°C 68°F)

## 1. Standard (B.B.M.) type

## 2 Form C type

## 1. Single side stable

Part No.		Nominal voltage, V DC	Pick-up voltage, V DC (max.)	Drop-out voltage, V DC (min.)	Nominal operating current, mA (±10%)	Coil resistance, Ω (±10%)	Nominal operating power, mW	Max. allowable voltage, V DC
Standard PC board terminal	Self-clinching terminal							
TQ2-3 V	TQ2H-3 V	3	2.25	0.3	46.7	64.3	140	4.5
TQ2-4.5 V	TQ2H-4.5 V	4.5	3.38	0.45	31.1	144.6	140	6.7
TQ2-5 V	TQ2H-5 V	5	3.75	0.5	28.1	178	140	7.5
TQ2-6 V	TQ2H-6 V	6	4.5	0.6	23.3	257	140	9
TQ2-9 V	TQ2H-9 V	9	6.75	0.9	15.5	579	140	13.5
TQ2-12 V	TQ2H-12 V	12	9	1.2	11.7	1,028	140	18
TQ2-24 V	TQ2H-24 V	24	18	2.4	8.3	2,880	200	36
TQ2-48 V	TQ2H-48 V	48	36	4.8	6.25	7,680	300	57.6

## 2. 1 Coil latching

Part No.		Nominal voltage, V DC	Set voltage, V DC (max.)	Reset voltage, V DC (min.)	Nominal operating current, mA (±10%)	Coil resistance, Ω (±10%)	Nominal operating power, mW	Max. allowable voltage, V DC
Standard PC board terminal	Self-clinching terminal							
TQ2-L-3 V	TQ2H-L-3 V	3	2.25	2.25	33.3	90	100	4.5
TQ2-L-4.5 V	TQ2H-L-4.5 V	4.5	3.38	3.38	22.2	202.5	100	6.7
TQ2-L-5 V	TQ2H-L-5 V	5	3.75	3.75	20	250	100	7.5
TQ2-L-6 V	TQ2H-L-6 V	6	4.5	4.5	16.7	360	100	9
TQ2-L-9 V	TQ2H-L-9 V	9	6.75	6.75	11.1	810	100	13.5
TQ2-L-12 V	TQ2H-L-12 V	12	9	9	8.3	1,440	100	18
TQ2-L-24 V	TQ2H-L-24 V	24	18	18	6.3	3,840	150	36

## 3. 2 Coil latching

Part No.		Nominal voltage, V DC	Set voltage, V DC (max.)	Reset voltage, V DC (min.)	Nominal operating current, mA (±10%)	Coil resistance, Ω (±10%)	Nominal operating power, mW	Max. allowable voltage, V DC
Standard PC board terminal	Self-clinching terminal							
TQ2-L2-3 V	TQ2H-L2-3 V	3	2.25	2.25	66.7	45	200	4.5
TQ2-L2-4.5 V	TQ2H-L2-4.5 V	4.5	3.38	3.38	44.4	101.2	200	6.7
TQ2-L2-5 V	TQ2H-L2-5 V	5	3.75	3.75	40	125	200	7.5
TQ2-L2-6 V	TQ2H-L2-6 V	6	4.5	4.5	33.3	180	200	9
TQ2-L2-9 V	TQ2H-L2-9 V	9	6.75	6.75	22.2	405	200	13.5
TQ2-L2-12 V	TQ2H-L2-12 V	12	9	9	16.7	720	200	18
TQ2-L2-24 V	TQ2H-L2-24 V	24	18	18	12.5	1,920	300	28.8

Notes: 1. Specified value of the pick-up, drop-out, set and reset voltage is with the condition of square wave coil pulse.

2. Standard packing: Tube: 50 pcs.; Case: 1,000 pcs.

3. In case of 5 V transistor drive circuit, it is recommend to use 4.5 V type relay.

4. AgPd stationary contact types available for high resistance against contact sticking. When ordering, please add suffix "-3" like TQ2-12V-3.

**4 Form C type****1. Single side stable**

Part No.		Nominal voltage, V DC	Pick-up voltage, V DC (max.)	Drop-out voltage, V DC (min.)	Nominal operating current, mA ( $\pm 10\%$ )	Coil resistance, $\Omega$ ( $\pm 10\%$ )	Nominal operating power, mW	Max. allowable voltage, V DC
Standard PC board terminal	Self-clinching terminal							
TQ4-3 V	TQ4H-3 V	3	2.25	0.3	93.8	32	280	4.5
TQ4-4.5 V	TQ4H-4.5 V	4.5	3.38	0.45	62.2	72.3	280	6.7
TQ4-5 V	TQ4H-5 V	5	3.75	0.5	56.2	89	280	7.5
TQ4-6 V	TQ4H-6 V	6	4.5	0.6	46.5	129	280	9
TQ4-9 V	TQ4H-9 V	9	6.75	0.9	31.1	289	280	13.5
TQ4-12 V	TQ4H-12 V	12	9	1.2	23.3	514	280	18
TQ4-24 V	TQ4H-24 V	24	18	2.4	11.7	2,056	280	36
TQ4-48 V	TQ4H-48 V	48	36	4.8	8.3	5,760	400	57.6

**2. 1 Coil latching**

Part No.		Nominal voltage, V DC	Set voltage, V DC (max.)	Reset voltage, V DC (min.)	Nominal operating current, mA ( $\pm 10\%$ )	Coil resistance, $\Omega$ ( $\pm 10\%$ )	Nominal operating power, mW	Max. allowable voltage, V DC
Standard PC board terminal	Self-clinching terminal							
TQ4-L-3 V	TQ4H-L-3 V	3	2.25	2.25	66.6	45	200	4.5
TQ4-L-4.5 V	TQ4H-L-4.5 V	4.5	3.38	3.38	44.4	101.2	200	6.7
TQ4-L-5 V	TQ4H-L-5 V	5	3.75	3.75	40	125	200	7.5
TQ4-L-6 V	TQ4H-L-6 V	6	4.5	4.5	33.3	180	200	9
TQ4-L-9 V	TQ4H-L-9 V	9	6.75	6.75	22.2	405	200	13.5
TQ4-L-12 V	TQ4H-L-12 V	12	9	9	16.7	720	200	18
TQ4-L-24 V	TQ4H-L-24 V	24	18	18	8.3	2,880	200	36

**3. 2 Coil latching**

Part No.		Nominal voltage, V DC	Set voltage, V DC (max.)	Reset voltage, V DC (min.)	Nominal operating current, mA ( $\pm 10\%$ )	Coil resistance, $\Omega$ ( $\pm 10\%$ )	Nominal operating power, mW	Max. allowable voltage, V DC
Standard PC board terminal	Self-clinching terminal							
TQ4-L2-3 V	TQ4H-L2-3 V	3	2.25	2.25	133	22.5	400	4.5
TQ4-L2-4.5 V	TQ4H-L2-4.5 V	4.5	3.38	3.38	88.9	50.6	400	6.7
TQ4-L2-5 V	TQ4H-L2-5 V	5	3.75	3.75	80	62.5	400	7.5
TQ4-L2-6 V	TQ4H-L2-6 V	6	4.5	4.5	66.6	90	400	9
TQ4-L2-9 V	TQ4H-L2-9 V	9	6.75	6.75	44.4	202.5	400	13.5
TQ4-L2-12 V	TQ4H-L2-12 V	12	9	9	33.3	360	400	18
TQ4-L2-24 V	TQ4H-L2-24 V	24	18	18	16.7	1,440	400	36

- Notes: 1. Specified value of the pick-up, drop-out, voltage is with the condition of square wave coil pulse.  
2. Standard packing: Tube: 50 pcs.; Case: 1,000 pcs.  
3. In case of 5 V transistor drive circuit, it is recommend to use 4.5 V type relay.  
4. 1 coil latching and 2 coil latching types are also available by request. Please consult us for details.  
5. AgPd stationary contact types available for high resistance against contact sticking. When ordering, please add suffix "-3" like TQ2-12V-3.

**2. M.B.B. type****Single side stable**

Part No.		Nominal voltage, V DC	Pick-up voltage, V DC (max.)	Drop-out voltage, V DC (min.)	Nominal operating current, mA ( $\pm 10\%$ )	Coil resistance, $\Omega$ ( $\pm 10\%$ )	Nominal operating power, mW	Max. allowable voltage, V DC
Standard PC board terminal	Self-clinching terminal							
TQ2-2M-3 V	TQ2H-2M-3 V	3	2.4	0.3	66.7	45	200	4.5
TQ2-2M-4.5 V	TQ2H-2M-4.5 V	4.5	3.6	0.45	44.4	101	200	6.7
TQ2-2M-5 V	TQ2H-2M-5 V	5	4	0.5	40	125	200	7.5
TQ2-2M-6 V	TQ2H-2M-6 V	6	4.8	0.6	33.3	180	200	9
TQ2-2M-9 V	TQ2H-2M-9 V	9	7.2	0.9	22.2	405	200	13.5
TQ2-2M-12 V	TQ2H-2M-12 V	12	9.6	1.2	16.7	720	200	18
TQ2-2M-24 V	TQ2H-2M-24 V	24	19.2	2.4	8.3	2,880	200	36

- Notes: 1. Specified value of the pick-up, drop-out, set and reset voltage is with the condition of square wave coil pulse.  
2. Standard packing: Tube: 50 pcs.; Case: 1,000 pcs.  
3. In case of 5 V transistor drive circuit, it is recommend to use 4.5 V type relay.  
4. AgPd stationary contact types available for high resistance against contact sticking. When ordering, please add suffix "-3" like TQ2-12V-3.

1) 2 Form C, 2 Form D

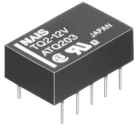

Standard PC board terminal

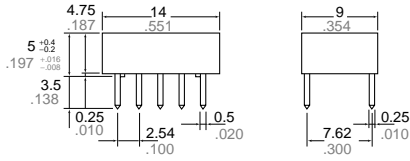

PC board pattern (Copper-side view)

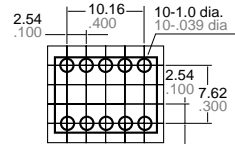

Tolerance:  $\pm 0.1 \pm 0.04$

Self-clinching terminal

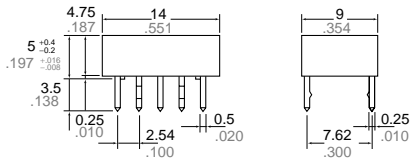

Schematic (Bottom view)

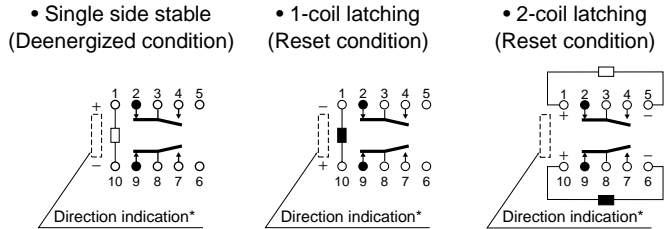

\*Orientation stripe typical-located on top of relay

General tolerance:  $\pm 0.3 \pm 0.12$

2) 4 Form C

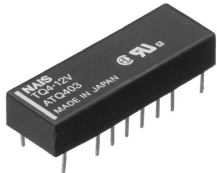

Standard PC board terminal

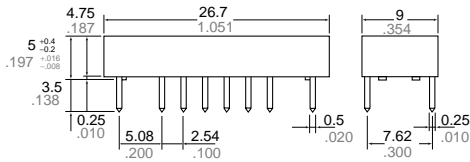

PC board pattern (Copper-side view)

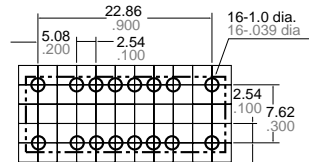

Tolerance:  $\pm 0.1 \pm 0.04$

Self-clinching terminal

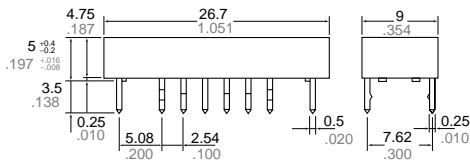

Schematic (Bottom view)

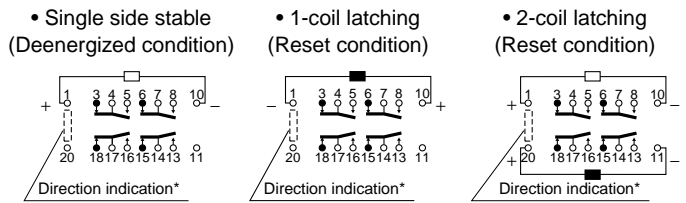

\*Orientation stripe typical-located on top of relay

General tolerance:  $\pm 0.3 \pm 0.12$

**REFERENCE DATA**

1. Maximum switching capacity

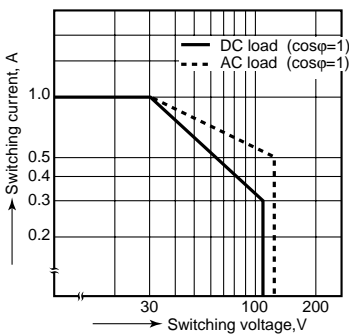

2. Life curve

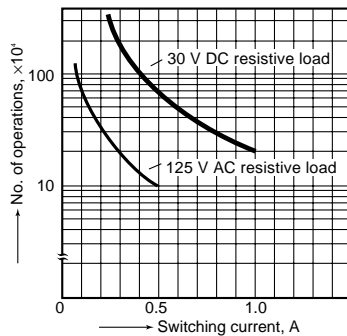

3. Mechanical life

Tested sample: TQ2-12V, 10 pcs.

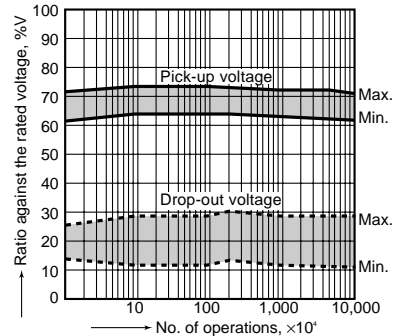

4.-(1) Electrical life (DC load)

Tested sample: TQ2-12V, 6 pcs.  
 Condition: 1 A 30 V DC resistive load, 20 cpm  
 Change of pick-up and drop-out voltage

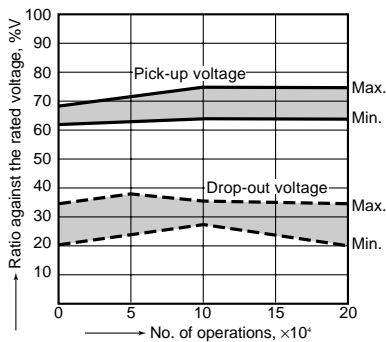

Change of contact resistance

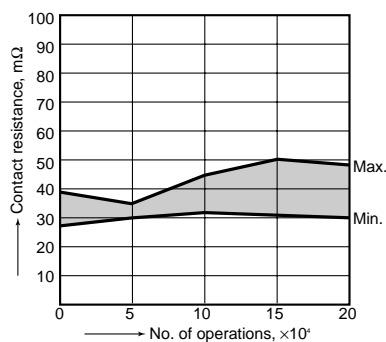

4.-(2) Electrical life (AC load)

Tested sample: TQ2-12V, 6 pcs.  
 Condition: 0.5 A 125 V AC resistive load, 20 cpm  
 Change of pick-up and drop-out voltage

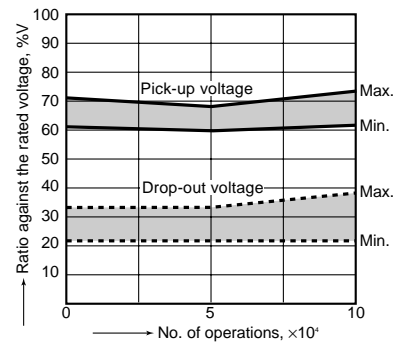

Change of contact resistance

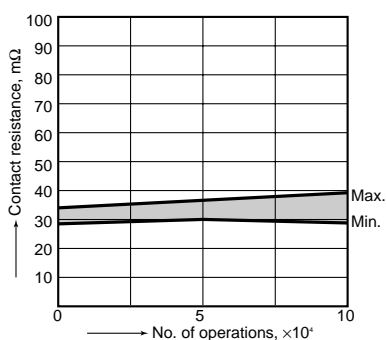

5.-(1) Coil temperature rise (2C)

Tested sample: TQ2-12V  
 Measured portion: Inside the coil  
 Ambient temperature: 30°C 86°F

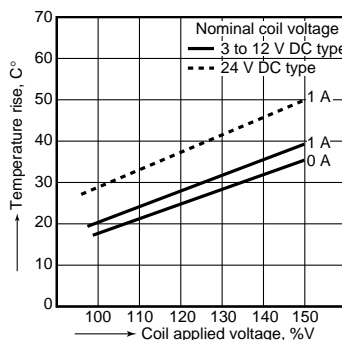

5.-(2) Coil temperature rise (4C)

Tested sample: TQ4-12V  
 Measured portion: Inside the coil  
 Ambient temperature: 30°C 86°F

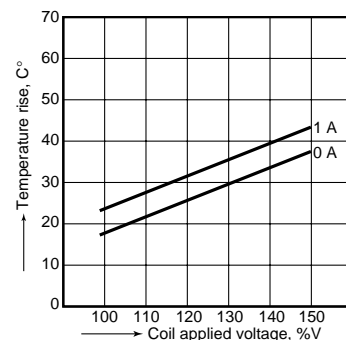

6.-(1) Operate/release time characteristics

Tested sample: TQ2-12V, 10 pcs.

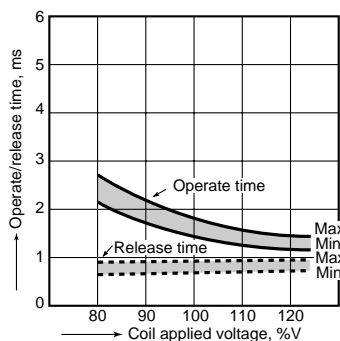

6.-(2) Operate/release time characteristics

Tested sample: TQ4-12V, 10 pcs.

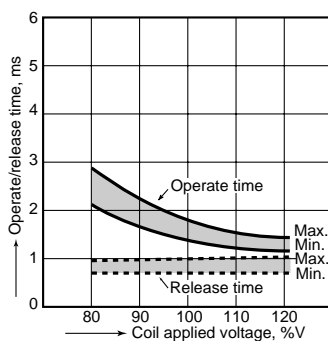

7. Distribution of pick-up and drop-out voltages

Tested sample: TQ2-12V, 50 pcs.

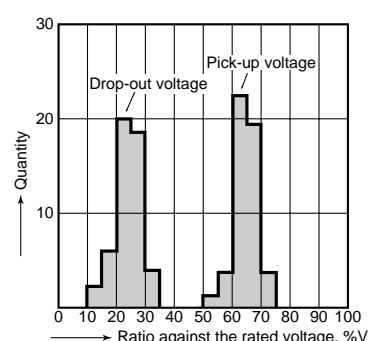

8. Distribution of set and reset voltage

Tested sample: TQ2-L2-12V, 35 pcs.

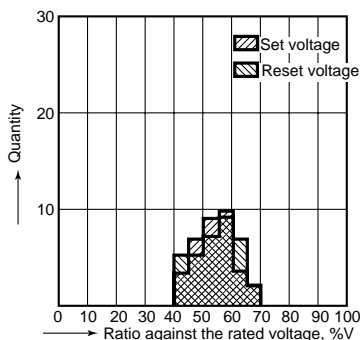

9. Ambient temperature characteristics

Tested sample: TQ2-12V, 5 pcs.

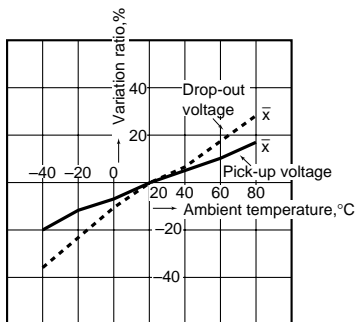

10. Distribution of contact resistance

Tested sample: TQ2-12V, 30 pcs. (30x4 contacts)

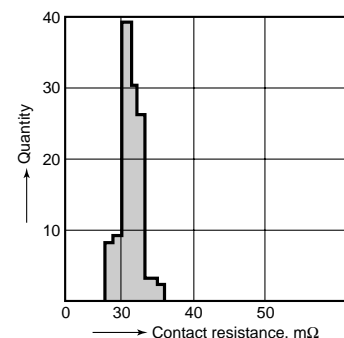

11.-(1) High-frequency characteristics  
Isolation characteristics

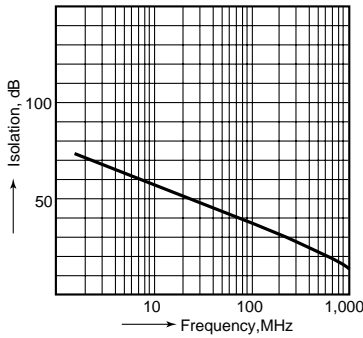

11.-(2) High-frequency characteristics  
Insertion loss characteristics

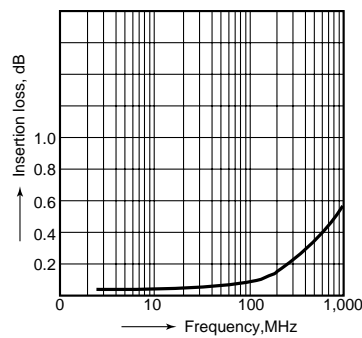

11.-(3) High-frequency characteristics  
V.S.W.R.

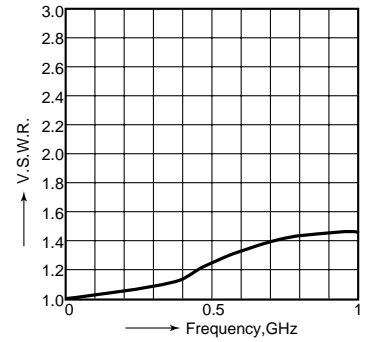

12.-(1) Malfunctional shock (single side stable)  
Tested sample: TQ2-12V, 6 pcs.

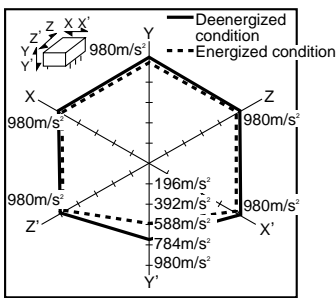

12.-(2) Malfunctional shock (latching)  
Tested sample: TQ2-L-12V, 6 pcs.

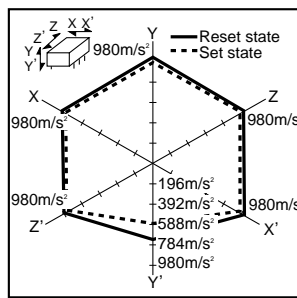

13.-(1) Influence of adjacent mounting

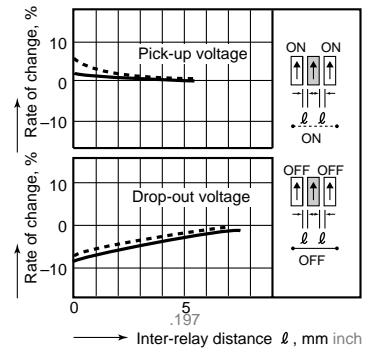

13.-(2) Influence of adjacent mounting

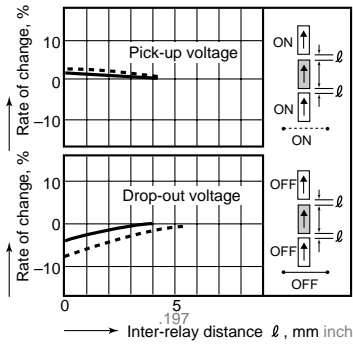

13.-(3) Influence of adjacent mounting

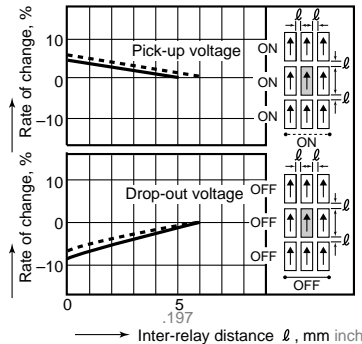

14.-(1) Contact reliability  
(1 mA 5 V DC resistive load)  
Tested sample: TQ2-12V  
Condition: Detection level 10 Ω

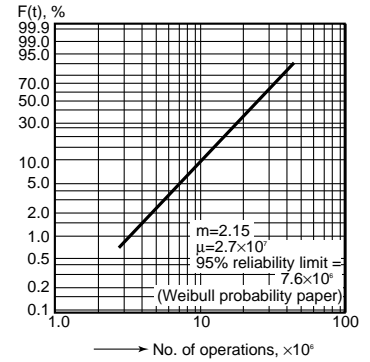

14.-(2) Contact reliability  
(100 μA 5 V DC resistive load)  
Tested sample: TQ2-12V  
Condition: Detection level 100 Ω

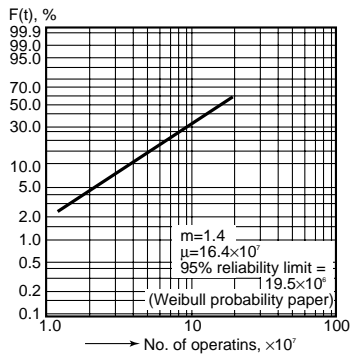

15. Actual load test (35 mA 48 V DC wire spring relay load)

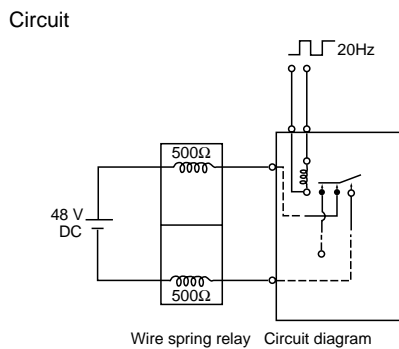

Change of pick-up and drop-out voltage

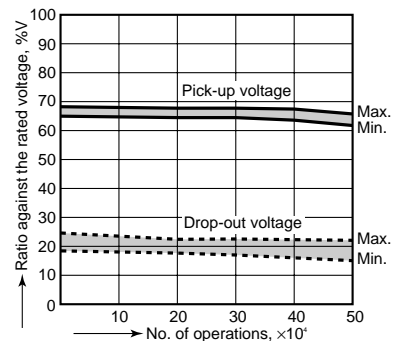

Change of contact resistance

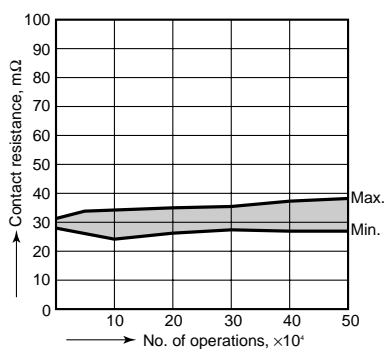

16. 0.1 A 53 V DC resistive load test  
Change of pick-up and drop-out voltage

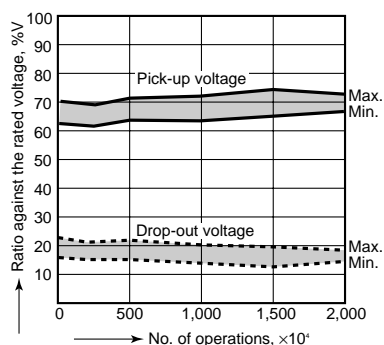

Change of contact resistance

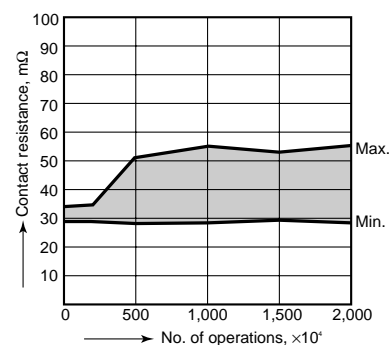

17.-(1) Distribution of M.B.B. time

Sample: TQ2-2M-5V, 85 pcs.  
Terminal Nos. 2-3-4: ON

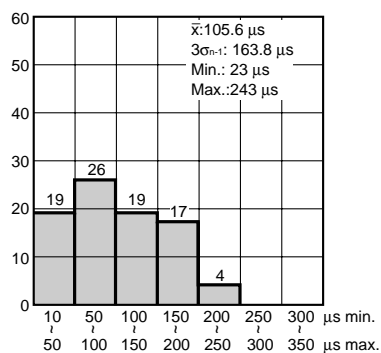

Terminal Nos. 2-3-4: OFF

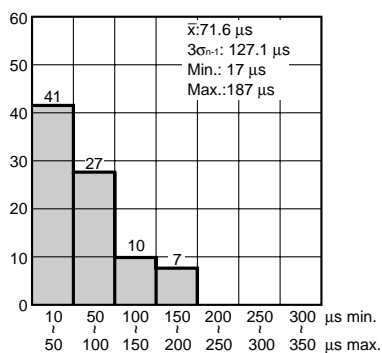

17.-(2) Distribution of M.B.B. time

Sample: TQ2-2M-5V, 85 pcs.  
Terminal Nos. 7-8-9: ON

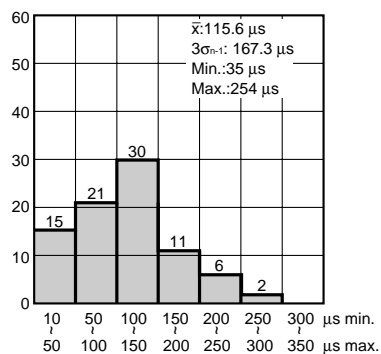

Terminal Nos. 7-8-9: OFF

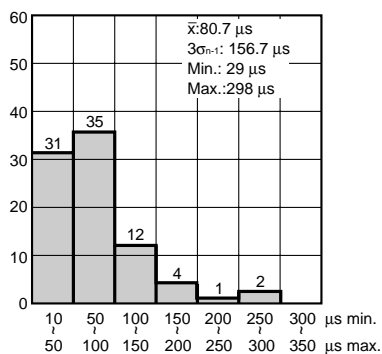

**For Cautions for Use, see Page 178 and 179.**